



> PRINT

ECOSYS P3045dn
ECOSYS P3050dn
ECOSYS P3055dn
ECOSYS P3060dn

OPERATION GUIDE



Preface

Thank you for purchasing this machine.

This Operation Guide is intended to help you operate the machine correctly, perform routine maintenance, and take simple troubleshooting measures as needed so that the machine can always be used in the optimum condition.

Please read this Operation Guide before using the machine.

To maintain quality, we recommend using genuine Kyocera toner containers, which must pass numerous quality inspections.

The use of non-genuine toner containers may cause failure.

We will not be liable for any damages caused by the use of third party supplies in this machine.

A label is affixed to our genuine supplies as shown below.

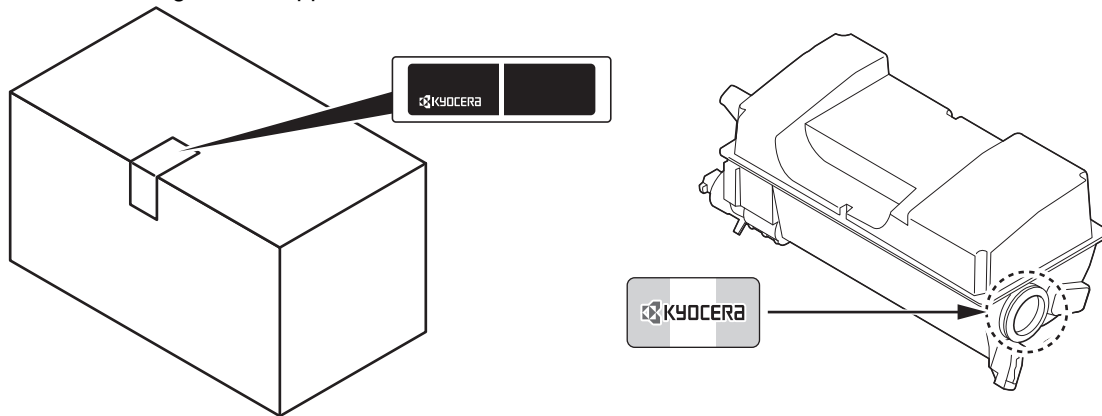

Checking the Equipment's Serial Number

The equipment's serial number is printed in the location shown in the figure.

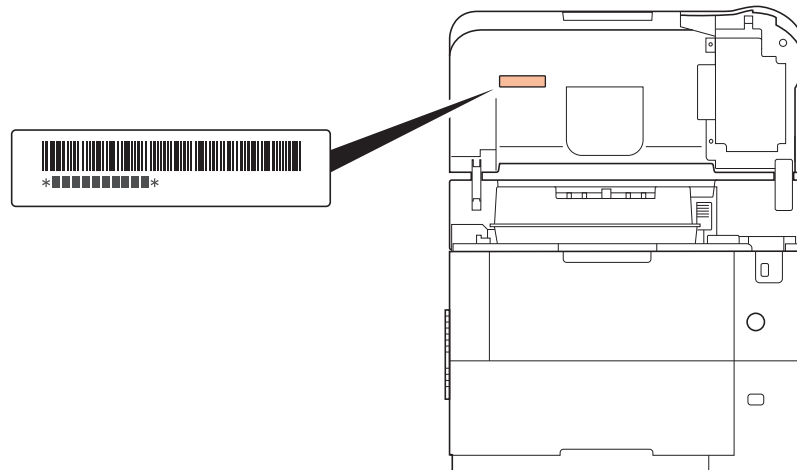

The equipment's serial number is printed on the rear side of the printer in some regions.

You'll need the equipment's serial number when contacting your Service Representative. Please check the number before contacting your Service Representative.

Included Guides

The following guides are supplied with the machine. Refer to them as necessary.

Quick Guide	Describes the procedures for installation of the machine.
Safety Guide	Provides safety and cautionary information for the installation and use of the machine. Be sure to read this guide before using the machine.
Safety Guide (ECOSYS P3045dn/ECOSYS P3050dn/ECOSYS P3055dn/ECOSYS P3060dn)	Describes the machine installation space, cautionary space, and other information. Be sure to read this guide before using the machine.

Product Library disc

Operation Guide (This Guide)	Describes how to load paper, basic print operations, and troubleshooting.
Command Center RX User Guide	Describes how to access the machine from a computer via a Web browser to check and change settings.
Printing System Driver User Guide	Describes how to install the printer driver and use printer functionality.
KYOCERA Net Direct Print Operation Guide	Describes how to use functionality for printing PDF files without launching Adobe Acrobat or Reader.
KYOCERA Net Viewer User Guide	Describes how to monitor the network printing system with KYOCERA Net Viewer.
Card Authentication Kit(B) Operation Guide	Describes how to authenticate to the machine using the ID card.
Data Security Kit(E) Operation Guide	Describes how to install and configure the Data Security Kit.
PRESCRIBE Commands Command Reference	Describes the native printer language (PRESCRIBE commands).
PRESCRIBE Commands Technical Reference	Describes PRESCRIBE command functionality and control for each type of emulation.
Maintenance Menu User Guide	Maintenance Menu provides the explanation on how to configure the print settings.

Safety Conventions in This Guide

The sections of this guide and parts of the machine marked with symbols are safety warnings meant to protect the user, other individuals and surrounding objects, and ensure correct and safe usage of the machine. The symbols and their meanings are indicated below.



WARNING: Indicates that serious injury or even death may result from insufficient attention to or incorrect compliance with the related points.



CAUTION: Indicates that personal injury or mechanical damage may result from insufficient attention to or incorrect compliance with the related points.

Symbols

The \triangle symbol indicates that the related section includes safety warnings. Specific points of attention are indicated inside the symbol.



... [General warning]



... [Warning of high temperature]

The \circledR symbol indicates that the related section includes information on prohibited actions. Specifics of the prohibited action are indicated inside the symbol.



... [Warning of prohibited action]



... [Disassembly prohibited]

The \bullet symbol indicates that the related section includes information on actions which must be performed. Specifics of the required action are indicated inside the symbol.



... [Alert of required action]



... [Remove the power plug from the outlet]



... [Always connect the machine to an outlet with a ground connection]

Please contact your service representative to order a replacement if the safety warnings in this Operation Guide are illegible or if the guide itself is missing (fee required).



Note An original which resembles a bank note closely may not be copied properly in some rare cases because this machine is equipped with a counterfeiting prevention function.

Contents

Legal and Safety Information	vi
1 Machine Parts	
Components at the Front/Right of the Printer	1-2
Components at the Front/Left of the Printer	1-2
Internal Components	1-3
Components at the Rear of the Printer	1-4
Operation Panel	1-5
2 Preparation before Use	
Changing Network Interface Parameters	2-2
Configuring the Wireless Network	2-7
Setting Wi-Fi Direct	2-12
Printing a Status Page	2-16
Installing Software	2-17
Status Monitor	2-24
Command Center RX	2-28
Power On/Off	2-35
Energy Saver Function	2-36
Loading Paper	2-38
3 Printing	
Printing from Applications	3-2
Canceling a Printing Job	3-2
Printer Driver Print Settings Screen	3-3
Printing on Non-standard Sized Paper	3-4
Banner Printing	3-5
Printer Driver Help	3-7
Changing the Default Printer Driver Settings (Windows 8.1)	3-7
Printing Functions	3-8
4 Operation Panel	
Message Display	4-2
Keys	4-4
Using the Menu Selection System	4-7
Setting a Mode Selection Menu	4-9
Report	4-10
USB Memory (USB memory selection)	4-21
Counter (Viewing the counter value)	4-29
Paper Settings	4-30
Print Settings	4-44
Network (Network settings)	4-60
Optional Network (Optional Network settings)	4-82
Device Common (Selecting/Setting the common device)	4-93
Security (Security function setting)	4-121
User/Job Account (User Login Setting/Job Account setting)	4-129
Adjust/Maint. (Adjust/Maintenance selection/setting)	4-150
Op Functions (Optional application settings)	4-154
5 Document Box	
Document Box	5-2
Custom Box	5-3
Job Box	5-21
Computer Settings (Printer Driver)	5-30
6 Status Menu	

Displaying the Status Menu Screen	6-2
Job Status	6-3
Job Log	6-4
USB Keyboard	6-5
Network	6-5
Wi-Fi	6-6
Wi-Fi Direct	6-6
Option Network	6-8
7 Maintenance	
Toner Container Replacement	7-2
Replacing the Waste Toner Box	7-7
Cleaning the Printer	7-9
Prolonged Non-Use and Moving of the Printer	7-11
8 Troubleshooting	
Troubleshooting	8-2
Error Messages	8-6
Clearing Paper Jams	8-18
Appendix	A-1
Character Entry Method	A-2
About the Options	A-5
Expansion Memory Modules	A-6
General Description of Options	A-7
Paper	A-11
Specifications	A-21
Glossary	Glossary-1
Index	Index-1

Legal and Safety Information



CAUTION NO LIABILITY IS ASSUMED FOR ANY DAMAGE CAUSED BY IMPROPER INSTALLATION.

Notice on Software

SOFTWARE USED WITH THIS PRINTER MUST SUPPORT THE PRINTER'S EMULATION MODE. The printer is factory-set to emulate the PCL.

Notice

The information in this guide is subject to change without notification. Additional pages may be inserted in future editions. The user is asked to excuse any technical inaccuracies or typographical errors in the present edition.

No responsibility is assumed if accidents occur while the user is following the instructions in this guide. No responsibility is assumed for defects in the printer's firmware (contents of its read-only memory).

This guide, any copyrightable subject matter sold or provided with or in connection with the sale of the page printer, are protected by copyright. All rights are reserved. Copying or other reproduction of all or part of this guide, any copyrightable subject matter without the prior written consent of KYOCERA Document Solutions Inc. is prohibited. Any copies made of all or part of this guide, any copyrightable subject must contain the same copyright notice as the material from which the copying is done.

Regarding Trade Names

- PRESCRIBE and ECOSYS are registered trademark of Kyocera Corporation.
- KPDL is a trademark of Kyocera Corporation.
- Microsoft, Windows, Windows XP, Windows Server 2003, Windows Vista, Windows Server 2008, Windows 7, Windows Server 2012, Windows 8, Windows 8.1, Windows 10 and Internet Explorer are registered trademarks or trademarks of Microsoft Corporation in the U.S.A. and/or other countries.
- PCL is a trademark of Hewlett-Packard Company.
- Adobe Acrobat, Adobe Reader and PostScript are trademarks of Adobe Systems Incorporated.
- Ethernet is a registered trademark of Xerox Corporation.
- Novell and NetWare are registered trademarks of Novell, Inc.
- IBM and IBM PC/AT are trademarks of International Business Machines Corporation.
- AppleTalk, Bonjour, Macintosh, and Mac OS are trademarks of Apple Inc., registered in the U.S. and other countries.
- All European language fonts installed in this machine are used under licensing agreement with Monotype Imaging Inc.
- Helvetica, Palatino and Times are registered trademarks of Linotype GmbH.
- ITC Avant Garde Gothic, ITC Bookman, ITC ZapfChancery and ITC ZapfDingbats are registered trademarks of International Typeface Corporation.
- ThinPrint is a trademark of Cortado AG in Germany and other countries.
- UFST™ MicroType® fonts by Monotype Imaging Inc. are installed in this machine.
- This machine contains the software having modules developed by Independent JPEG Group.
- iPad, iPhone and iPod touch are trademarks of Apple Inc., registered in the U.S. and other countries.
- AirPrint and the AirPrint logo are trademarks of Apple Inc.
- iOS is a trademark or registered trademark of Cisco in the U.S. and other countries and is used under license by Apple Inc.
- Google and Google Cloud Print™ are trademarks and/or registered trademarks of Google Inc.
- Wi-Fi and Wi-Fi Direct are trademarks and/or registered trademarks of Wi-Fi Alliance.

All other brands and product names are registered trademarks or trademarks of their respective companies. The designations ™ and ® will not be used in this Operation Guide.

License Agreements

GPL/LGPL

This product contains GPL (<http://www.gnu.org/licenses/gpl.html>) and/or LGPL (<http://www.gnu.org/licenses/lgpl.html>) software as part of its firmware. You can get the source code, and you are permitted to copy, redistribute and modify it under the terms of GPL/LGPL. For further information including availability of the source code, visit <http://www.kyoceradocumentsolutions.com/gpl/>.

Open SSL License

Copyright © 1998-2006 The OpenSSL Project. All rights reserved.

Redistribution and use in source and binary forms, with or without modification, are permitted provided that the following conditions are met:

- 1 Redistributions of source code must retain the above copyright notice, this list of conditions and the following disclaimer.
- 2 Redistributions in binary form must reproduce the above copyright notice, this list of conditions and the following disclaimer in the documentation and/or other materials provided with the distribution.
- 3 All advertising materials mentioning features or use of this software must display the following acknowledgment: "This product includes software developed by the OpenSSL Project for use in the OpenSSL Toolkit. (<http://www.openssl.org/>)"
- 4 The names "OpenSSL Toolkit" and "OpenSSL Project" must not be used to endorse or promote products derived from this software without prior written permission. For written permission, please contact openssl-core@openssl.org.
- 5 Products derived from this software may not be called "OpenSSL" nor may "OpenSSL" appear in their names without prior written permission of the OpenSSL Project.
- 6 Redistributions of any form whatsoever must retain the following acknowledgment: "This product includes software developed by the OpenSSL Project for use in the OpenSSL Toolkit (<http://www.openssl.org/>)"

THIS SOFTWARE IS PROVIDED BY THE OpenSSL PROJECT "AS IS" AND ANY EXPRESSED OR IMPLIED WARRANTIES, INCLUDING, BUT NOT LIMITED TO, THE IMPLIED WARRANTIES OF MERCHANTABILITY AND FITNESS FOR A PARTICULAR PURPOSE ARE DISCLAIMED. IN NO EVENT SHALL THE OpenSSL PROJECT OR ITS CONTRIBUTORS BE LIABLE FOR ANY DIRECT, INDIRECT, INCIDENTAL, SPECIAL, EXEMPLARY, OR CONSEQUENTIAL DAMAGES (INCLUDING, BUT NOT LIMITED TO, PROCUREMENT OF SUBSTITUTE GOODS OR SERVICES; LOSS OF USE, DATA, OR PROFITS; OR BUSINESS INTERRUPTION) HOWEVER CAUSED AND ON ANY THEORY OF LIABILITY, WHETHER IN CONTRACT, STRICT LIABILITY, OR TORT (INCLUDING NEGLIGENCE OR OTHERWISE) ARISING IN ANY WAY OUT OF THE USE OF THIS SOFTWARE, EVEN IF ADVISED OF THE POSSIBILITY OF SUCH DAMAGE.

Original SSLeay License

Copyright © 1995-1998 Eric Young (eay@cryptsoft.com) All rights reserved.

This package is an SSL implementation written by Eric Young (eay@cryptsoft.com). The implementation was written so as to conform with Netscapes SSL.

This library is free for commercial and non-commercial use as long as the following conditions are adhered to. The following conditions apply to all code found in this distribution, be it the RC4, RSA, lhash, DES, etc., code; not just the SSL code. The SSL documentation included with this distribution is covered by the same copyright terms except that the holder is Tim Hudson (tjh@cryptsoft.com).

Copyright remains Eric Young's, and as such any Copyright notices in the code are not to be removed.

If this package is used in a product, Eric Young should be given attribution as the author of the parts of the library used.

This can be in the form of a textual message at program startup or in documentation (online or textual) provided with the package.

Redistribution and use in source and binary forms, with or without modification, are permitted provided that the following conditions are met:

-
- 1 Redistributions of source code must retain the copyright notice, this list of conditions and the following disclaimer.
 - 2 Redistributions in binary form must reproduce the above copyright notice, this list of conditions and the following disclaimer in the documentation and/or other materials provided with the distribution.
 - 3 All advertising materials mentioning features or use of this software must display the following acknowledgement:
"This product includes cryptographic software written by Eric Young (eay@cryptsoft.com)"
The word 'cryptographic' can be left out if the routines from the library being used are not cryptographic related :-).
 - 4 If you include any Windows specific code (or a derivative thereof) from the apps directory (application code) you must include an acknowledgement:
"This product includes software written by Tim Hudson (tjh@cryptsoft.com)"

THIS SOFTWARE IS PROVIDED BY ERIC YOUNG "AS IS" AND ANY EXPRESS OR IMPLIED WARRANTIES, INCLUDING, BUT NOT LIMITED TO, THE IMPLIED WARRANTIES OF MERCHANTABILITY AND FITNESS FOR A PARTICULAR PURPOSE ARE DISCLAIMED. IN NO EVENT SHALL THE AUTHOR OR CONTRIBUTORS BE LIABLE FOR ANY DIRECT, INDIRECT, INCIDENTAL, SPECIAL, EXEMPLARY, OR CONSEQUENTIAL DAMAGES (INCLUDING, BUT NOT LIMITED TO, PROCUREMENT OF SUBSTITUTE GOODS OR SERVICES; LOSS OF USE, DATA, OR PROFITS; OR BUSINESS INTERRUPTION) HOWEVER CAUSED AND ON ANY THEORY OF LIABILITY, WHETHER IN CONTRACT, STRICT LIABILITY, OR TORT (INCLUDING NEGLIGENCE OR OTHERWISE) ARISING IN ANY WAY OUT OF THE USE OF THIS SOFTWARE, EVEN IF ADVISED OF THE POSSIBILITY OF SUCH DAMAGE.

The licence and distribution terms for any publically available version or derivative of this code cannot be changed. i.e. this code cannot simply be copied and put under another distribution licence [including the GNU Public Licence.]

Monotype Imaging License Agreement

- 1 Software shall mean the digitally encoded, machine readable, scalable outline data as encoded in a special format as well as the UFST Software.
- 2 You agree to accept a non-exclusive license to use the Software to reproduce and display weights, styles and versions of letters, numerals, characters and symbols (Typefaces) solely for your own customary business or personal purposes at the address stated on the registration card you return to Monotype Imaging. Under the terms of this License Agreement, you have the right to use the Fonts on up to three printers. If you need to have access to the fonts on more than three printers, you need to acquire a multi-user license agreement which can be obtained from Monotype Imaging. Monotype Imaging retains all rights, title and interest to the Software and Typefaces and no rights are granted to you other than a License to use the Software on the terms expressly set forth in this Agreement.
- 3 To protect proprietary rights of Monotype Imaging, you agree to maintain the Software and other proprietary information concerning the Typefaces in strict confidence and to establish reasonable procedures regulating access to and use of the Software and Typefaces.
- 4 You agree not to duplicate or copy the Software or Typefaces, except that you may make one backup copy. You agree that any such copy shall contain the same proprietary notices as those appearing on the original.
- 5 This License shall continue until the last use of the Software and Typefaces, unless sooner terminated. This License may be terminated by Monotype Imaging if you fail to comply with the terms of this License and such failure is not remedied within thirty (30) days after notice from Monotype Imaging. When this License expires or is terminated, you shall either return to Monotype Imaging or destroy all copies of the Software and Typefaces and documentation as requested.
- 6 You agree that you will not modify, alter, disassemble, decrypt, reverse engineer or decompile the Software.
- 7 Monotype Imaging warrants that for ninety (90) days after delivery, the Software will perform in accordance with Monotype Imaging-published specifications, and the diskette will be free from defects in material and workmanship. Monotype Imaging does not warrant that the Software is free from all bugs, errors and omissions.

The parties agree that all other warranties, expressed or implied, including warranties of fitness for a particular purpose and merchantability, are excluded.

- 8 Your exclusive remedy and the sole liability of Monotype Imaging in connection with the Software and Typefaces is repair or replacement of defective parts, upon their return to Monotype Imaging.

In no event will Monotype Imaging be liable for lost profits, lost data, or any other incidental or consequential damages, or any damages caused by abuse or misapplication of the Software and Typefaces.

- 9 Massachusetts U.S.A. law governs this Agreement.
- 10 You shall not sublicense, sell, lease, or otherwise transfer the Software and/or Typefaces without the prior written consent of Monotype Imaging.
- 11 Use, duplication or disclosure by the Government is subject to restrictions as set forth in the Rights in Technical Data and Computer Software clause at FAR 252-227-7013, subdivision (b)(3)(ii) or subparagraph (c)(1)(ii), as appropriate. Further use, duplication or disclosure is subject to restrictions applicable to restricted rights software as set forth in FAR 52.227-19 (c)(2).
- 12 You acknowledge that you have read this Agreement, understand it, and agree to be bound by its terms and conditions. Neither party shall be bound by any statement or representation not contained in this Agreement. No change in this Agreement is effective unless written and signed by properly authorized representatives of each party. By opening this diskette package, you agree to accept the terms and conditions of this Agreement.

Energy Saving Control Function

To reduce energy consumption while in a waiting state, the device comes equipped with an energy saving control function for switching to a **Sleep Mode** where power consumption is automatically reduced to a minimum after a certain amount of time elapses since the device was last used. For details, refer to *Energy Saver Function on page 2-36*.

Sleep

The device automatically enters Sleep when 1 minute has passed since the device was last used. The amount of time of no activity that must pass before Sleep is activated may be lengthened. For more information, refer to *Sleep Timer (Sleep timer timeout time)* section.

There are two sleep modes: Quick Recovery and Energy Saver. The default setting is Energy Saver mode.

Quick Recovery Mode

The recovery from the sleep mode is faster than when using Energy Saver Mode. The machine automatically recovers and prints when a job is detected.

Energy Saver Mode

Makes it possible to reduce energy consumption even further than with Quick Recovery Mode.

Power Off Timer (For Europe)

If the printer is not used while in sleep mode, the power automatically turns off. The Power Off Timer is used to set the time until the power turns off. The factory setting for the time until the power turns off is 3 days.

Duplex Printing

This printer includes duplex printing as a standard function. For example, by printing two single-sided originals onto a single sheet of paper as a duplex printing, it is possible to lower the amount of paper used. For more information refer to *Duplex (Setting the duplex printing) on page 4-46*.

Printing in duplex mode reduces paper consumption and contributes to the conservation of forest resources. Duplex mode also reduces the amount of paper that must be purchased, and thereby reduces cost. It is recommended that machines capable of duplex printing be set to use duplex mode by default.

Resource Saving - Paper

For the preservation and sustainable use of forest resources, it is recommended that recycled as well as virgin paper certified under environmental stewardship initiatives or carrying recognised ecolabels, which meet EN 12281:2002*1 or an equivalent quality standard, be used.

This machine also supports printing on 64 g/m² paper. Using such paper containing less raw materials can lead to further saving of forest resources.

*1: EN12281:2002 "Printing and business paper - Requirements for copy paper for dry toner imaging processes"

Your sales or service representative can provide information about recommended paper types.

Environmental benefits of "Power Management"

To reduce power consumption when idle, this machine is equipped with a power management function that automatically activates energy-saving mode when the machine is idle for a certain period of time. Although it takes the machine a slight amount of time to return to READY mode when in energy-saving mode, a significant reduction in energy consumption is possible.

It is recommended that the machine be used with the activation time for energy-saving mode set to the default setting.

Energy Star (ENERGY STAR®)



We have determined as a participating company in the International Energy Star Program that this product is compliant with the standards laid out in the International Energy Star Program.

ENERGY STAR® is a voluntary energy efficiency program with the goal of developing and promoting the use of products with high energy efficiency in order to help prevent global warming. By purchasing ENERGY STAR® qualified products, customers can help reduce emissions of greenhouse gases during product use and cut energy-related costs.

EN ISO 7779

Der höchste Schalldruckpegel beträgt 70 dB (A) oder weniger gemäß EN ISO 7779.

EK1-ITB 2000

Das Gerät ist nicht für die Benutzung im unmittelbaren Gesichtsfeld am Bildschirmarbeitsplatz vorgesehen. Um störende Reflexionen am Bildschirmarbeitsplatz zu vermeiden, darf dieses Produkt nicht im unmittelbaren Gesichtsfeld platziert werden.

Wireless Connection (Mexico only)

The operation of this equipment is subject to the following two conditions:

(1) it is possible that this equipment or device may not cause harmful interference, and (2) this equipment or device must accept any interference, including interference that may cause undesired operation.

La operación de este equipo está sujeta a las siguientes dos condiciones:

(1) es posible que este equipo o dispositivo no cause interferencia perjudicial y (2) este equipo o dispositivo debe aceptar cualquier interferencia, incluyendo la que pueda causar su operación no deseada.

Security Precautions when Using Wireless LAN (If equipped)

Wireless LAN allows information to be exchanged between wireless access points instead of using a network cable, which offers the advantage that a LAN connection can be established freely within an area in which radio waves can be transmitted.

On the other hand, the following problems may occur if security settings are not configured, because radio waves can pass through obstacles (including walls) and reach everywhere within a certain area.

Secretly Viewing Communication Contents

A third person with malicious objectives may intentionally monitor radio waves and gain unauthorized access to the following communication contents.

- Personal information including ID, passwords, and credit card numbers
- Contents of email messages

Illegal Intrusion

A third party with malicious intent may gain unauthorized access to personal or company networks and conduct the following illegal actions.

- Extracting personal and confidential information (information leak)
- Entering into communication while impersonating a specific person and distributing unauthorized information (spoofing)
- Modifying and retransmitting intercepted communications (falsification)
- Transmitting computer viruses and destroying data and systems (destruction)

Wireless LAN cards and wireless access points contain built-in security mechanisms to address these problems and to reduce the possibility of these problems occurring by configuring the security settings of wireless LAN products when the product is used.

We recommend that customers take responsibility and use their judgment when configuring the security settings and that they ensure that they fully understand the problems that can occur when the product is used without configuring the security settings.

Limited Use of This Product (If equipped)

- Radio waves transmitted from this product may affect medical equipment. When using this product in a medical institution or in the vicinity of medical instruments, either use this product according to the instructions and precautions provided by the administrator of the institution or those provided on the medical instruments.
- Radio waves transmitted from this product may affect automatic control equipment including automatic doors and fire alarms. When using this product in the vicinity of the automatic control equipment, use this product according to the instructions and precautions provided on the automatic control equipment.
- If this product is used in devices that are directly related to service including airplanes, trains, ships, and automobiles or this product is used in applications requiring high reliability and safety to function and in devices requiring accuracy including those used in disaster prevention and crime prevention and those used for various safety purposes, please use this product after considering the safety design of the entire system including adoption of a failsafe design and redundancy design for reliability and safety maintenance of the entire system. This product is not intended for use in applications requiring high reliability and safety including aerospace instruments, trunk communication equipment, nuclear power control equipment, and medical equipment; hence, the decision as to whether to use this product in these applications needs to be fully considered and determined.

Environment

The service environmental conditions are as follows:

- Temperature: 50 to 90.5 °F (10 to 32.5 °C)
- Humidity: 15 to 80 %

However, adverse environmental conditions may affect the image quality. Avoid the following locations when selecting a site for the machine.

- Avoid locations near a window or with exposure to direct sunlight.
- Avoid locations with vibrations.
- Avoid locations with drastic temperature fluctuations.
- Avoid locations with direct exposure to hot or cold air.
- Avoid poorly ventilated locations.

If the floor is delicate against casters, when this machine is moved after installation, the floor material may be damaged.

During printing, some ozone is released, but the amount does not cause any ill effect to one's health. If, however, the machine is used over a long period of time in a poorly ventilated room or when printing an extremely large number of copies, the smell may become unpleasant. To maintain the appropriate environment for print work, it is suggested that the room be properly ventilated.

Interface connectors

IMPORTANT Be sure to power off the printer before connecting or disconnecting an interface cable. For protection against static electricity discharge to the printer's internal electronics through the interface connector(s), cover any interface connector that is not in use with the protective cap supplied.



Note Use shielded interface cables.

Cautions when Handling Consumables

Do not attempt to incinerate parts which contain toner. Dangerous sparks may cause burns.

Keep parts which contain toner out of the reach of children.

If toner happens to spill from parts which contain toner, avoid inhalation and ingestion, as well as contact with your eyes and skin.

- If you do happen to inhale toner, move to a place with fresh air and gargle thoroughly with a large amount of water. If coughing develops, contact a physician.
- If you do happen to ingest toner, rinse your mouth out with water and drink 1 or 2 cups of water to dilute the contents of your stomach. If necessary, contact a physician.
- If you do happen to get toner in your eyes, flush them thoroughly with water. If there is any remaining tenderness, contact a physician.
- If toner does happen to get on your skin, wash with soap and water.

Do not attempt to force open or destroy parts which contain toner.

Other precautions

Return the exhausted toner container and waste toner box to your dealer or service representative. The collected toner container and waste toner box will be recycled or disposed in accordance with the relevant regulations.

Store the machine while avoiding exposure to direct sunlight.

Store the machine in a place where the temperature stays below 40°C while avoiding sharp changes of temperature and humidity.

If the machine will not be used for an extended period of time, remove the paper from the cassette and the Multi Purpose (MP) Tray, return it to its original package and reseal it.

SAFETY OF LASER BEAM (USA)

1. Safety of laser beam

This machine has been certified by the manufacturer to Class 1 level under the radiation performance standards established by the U.S.DHHS (Department of Health and Human Services) in 1968. This indicates that the product is safe to use during normal operation and maintenance. The laser optical system, enclosed in a protective housing and sealed within the external covers, never permits the laser beam to escape.

2. The CDRH Act

A laser-product-related act was implemented on Aug. 2, 1976, by the Center for Devices and Radiological Health (CDRH) of the U.S. Food and Drug Administration (FDA). This act prohibits the sale of laser products in the U.S. without certification, and applies to laser products manufactured after Aug. 1, 1976. The label shown below indicates compliance with the CDRH regulations and must be attached to laser products marketed in the United States. On this machine, the label is on the inside of the top cover.

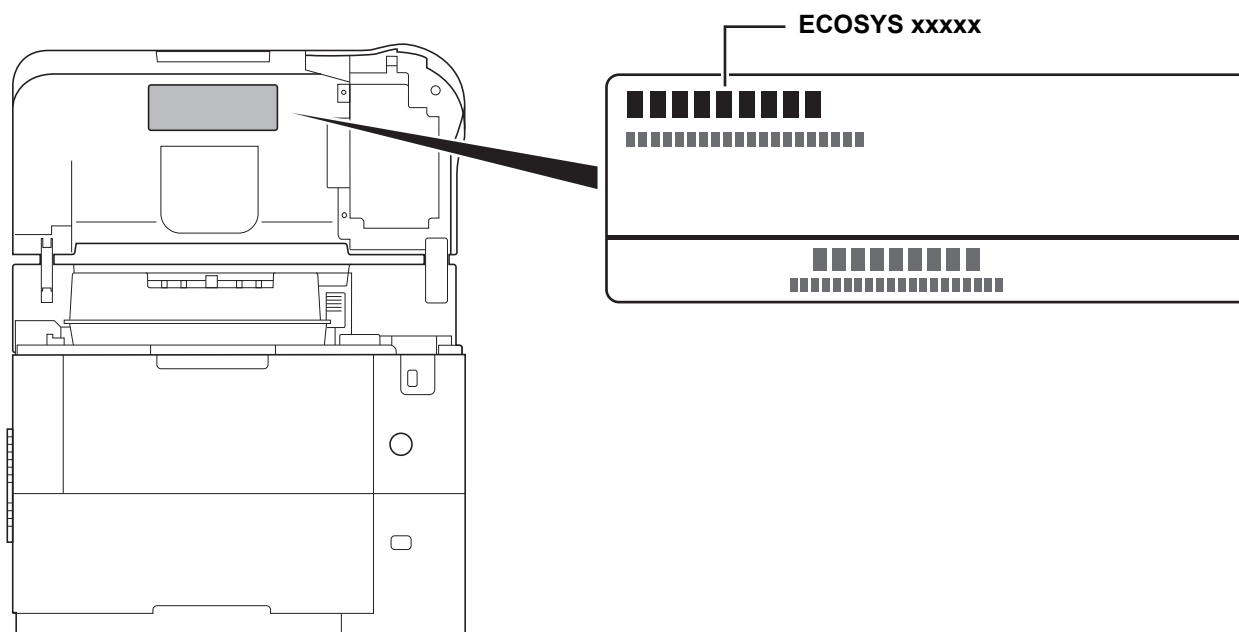

3. Maintenance

For safety of the service personnel, follow the maintenance instructions in the other section of this manual.

4. Safety switch

The power to the laser unit is cut off when the top cover is opened.

Safety Instructions Regarding the Disconnection of Power (USA)

Caution: The power plug is the main isolation device! Other switches on the equipment are only functional switches and are not suitable for isolating the equipment from the power source.

Attention: Le débranchement de la fiche secteur est le seul moyen de mettre l'appareil hors tension. Les interrupteurs sur l'appareil ne sont que des interrupteurs de fonctionnement: ils ne mettent pas l'appareil hors tension.

WARNING

This equipment has been tested and found to comply with the limits for a Class B digital device, pursuant to Part 15 of the FCC Rules. These limits are designed to provide reasonable protection against harmful interference in a residential installation. This equipment generates, uses and can radiate radio frequency energy and, if not installed and used in accordance with the instructions, may cause harmful interference to radio communications. However, there is no guarantee that interference will not occur in a particular installation. If this equipment does cause harmful interference to radio or television reception, which can be determined by turning the equipment off and on, the user is encouraged to try to correct the interference by one or more of the following measures:

- Reorient or relocate the receiving antenna.
- Increase the separation between the equipment and receiver.
- Connect the equipment into an outlet on a circuit different from that to which the receiver is connected.
- Consult the dealer or an experienced radio/TV technician for help.
- The use of a non-shielded interface cable with the referenced device is prohibited.

CAUTION — The changes or modifications not expressly approved by the party responsible for compliance could void the user's authority to operate the equipment.

This device complies with Part 15 of FCC Rules and RSS-Gen of IC Rules.

Operation is subject to the following two conditions; (1) this device may not cause interference, and (2) this device must accept any interference, including interference that may cause undesired operation of the device.

* The above warning is valid only in the United States of America.

Other precautions (for users in California, the United States)

Perchlorate Material - special handling may apply. See www.dtsc.ca.gov/hazardouswaste/perchlorate.

Laser Safety (Europe)

Laser radiation could be hazardous to the human body. For this reason, laser radiation emitted inside this machine is hermetically sealed within the protective housing and external cover. In the normal operation of the product by user, no radiation can leak from the machine.

This machine is classified as Class 1 laser product under IEC/EN 60825-1:2014.

Regarding CLASS 1 laser products, information is provided on the rating label.



About the Operation Guide

This Operation Guide has the following chapters:

Chapter 1 - Machine Parts

This chapter explains the names of parts.

Chapter 2 - Preparation before Use

This chapter explains the preparations and settings necessary before use and the method for loading paper.

Chapter 3 - Printing

This chapter explains the method for printing from a computer.

Chapter 4 - Operation Panel

This chapter explains how to use the operation panel to configure the printer.

Chapter 5 - Document Box

This chapter explains about the Document Box function.

Chapter 6 - Status Menu

This chapter explains how to check the job status and job history and how to cancel jobs being printed or waiting to print.

Chapter 7 - Maintenance

This chapter explains about the replacement of toner container and the cleaning of the printer.

Chapter 8 - Troubleshooting



This chapter explains how to handle error messages, paper jams and other problems.

Appendix

This section explains the method for entering characters, an introduction to optional products and the printer specifications.

Conventions

This manual uses the following conventions.

Convention	Description	Example
Italic Typeface	Used to emphasize a key word, phrase or reference to additional information.	To replace the toner container, refer to <i>Toner Container Replacement on page 3-2</i> .
Bold	Used to denote buttons on the software.	To start printing, click OK .
Bracket Bold	Used to denote operation panel keys.	Press [OK] to resume printing.
Note	Used to provide additional or useful information about a function or feature.	 Note Check with your network administrator for the network address settings.
Important	Used to provide important information.	IMPORTANT Ensure paper is not folded, curled, or damaged.
Caution	Indicates what must be observed to prevent injury or machine breakdown and how to deal with it.	 CAUTION The fuser unit inside the printer is hot. Do not touch it with your hands as it may result in burn injury.
Warning	Used to alert users to the possibility of <i>personal</i> injury.	 WARNING If you ship the printer, remove and pack the developer unit in a plastic bag and ship them separately from the printer.

1 Machine Parts

This chapter contains explanations on the following topics:

Components at the Front/Right of the Printer	1-2
Components at the Front/Left of the Printer	1-2
Internal Components	1-3
Components at the Rear of the Printer	1-4
Operation Panel	1-5

Components at the Front/Right of the Printer

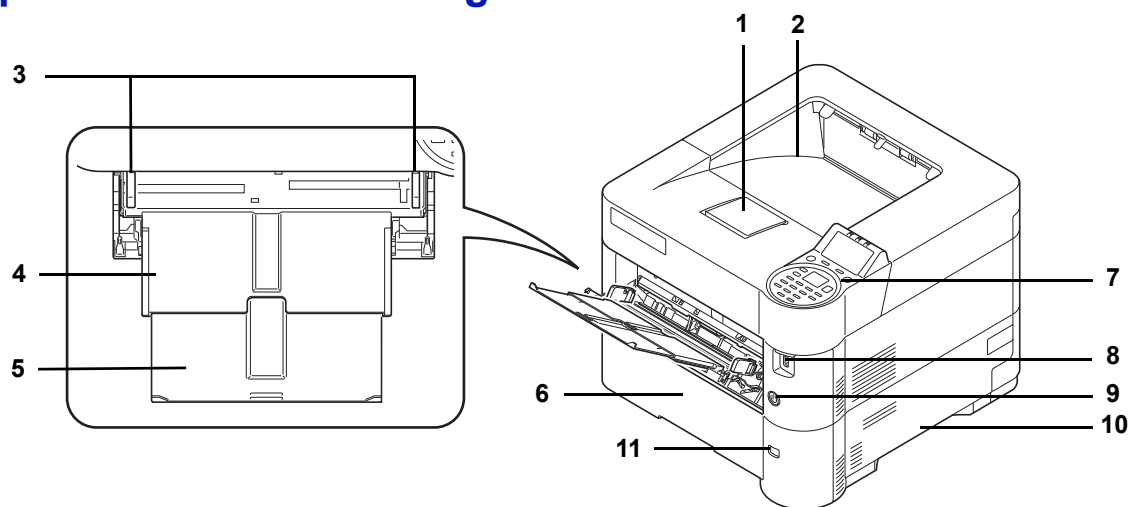

- 1 Paper Stopper
- 2 Top Tray
- 3 Paper Width Guides (MP tray)
- 4 MP (Multi-Purpose) Tray
- 5 Support Tray Section of the MP Tray
- 6 Cassette 1
- 7 Operation Panel
- 8 USB Memory Slot
- 9 Power Switch
- 10 Handholds
- 11 Paper Size Window

Components at the Front/Left of the Printer

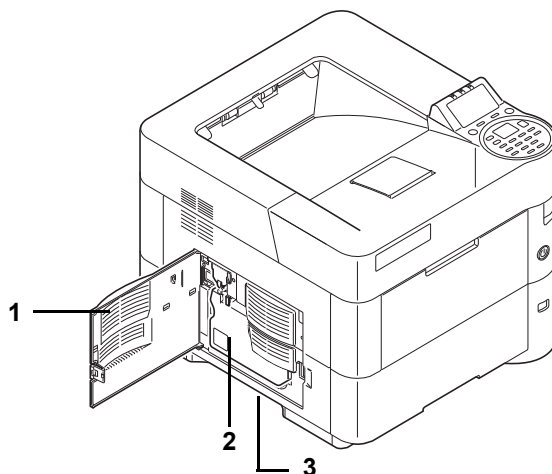

- 1 Left Cover
- 2 Waste Toner Box
- 3 Handholds

Internal Components

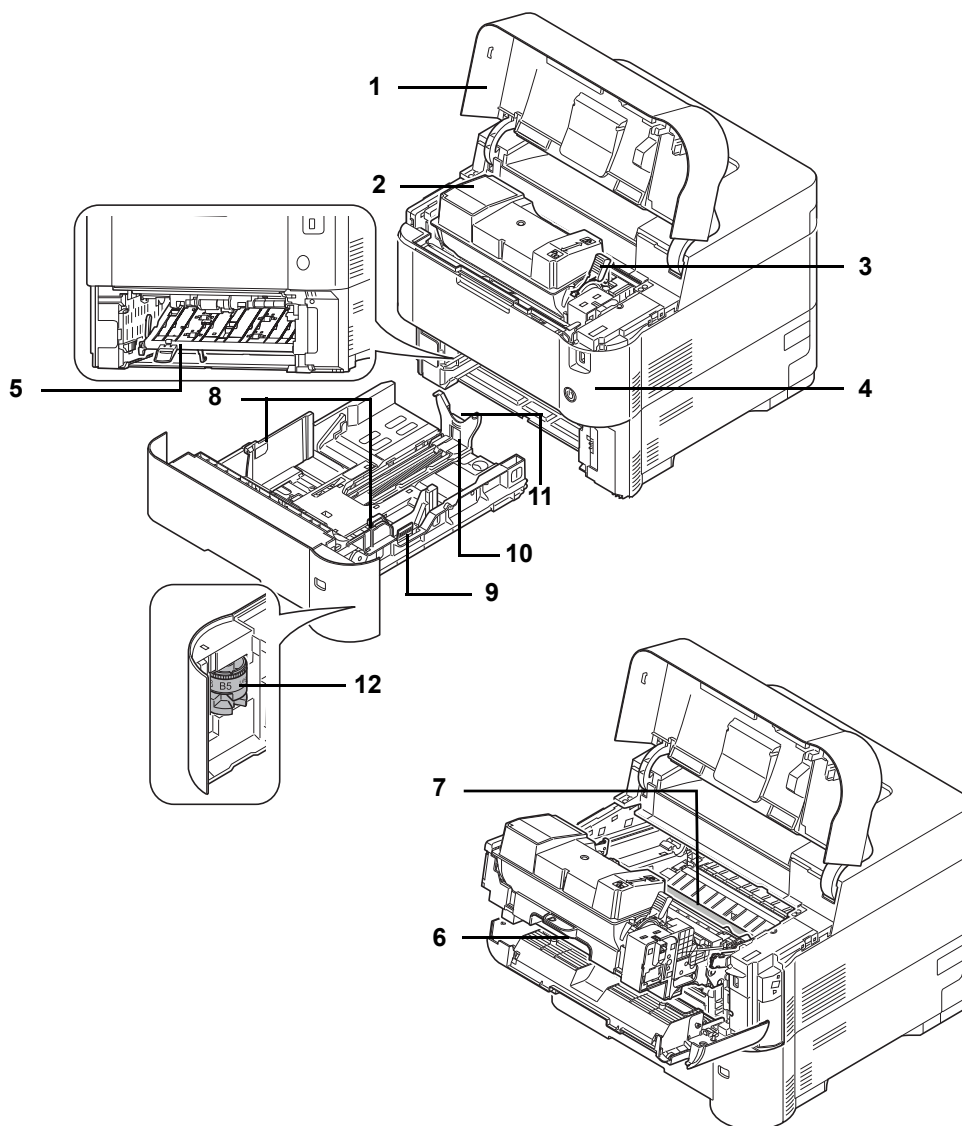

- 1 Top Cover
- 2 Toner Container
- 3 Lock Lever
- 4 Front Cover
- 5 Duplex Front Cover
- 6 Developer Unit
- 7 Registration Roller
- 8 Paper Width Guides
- 9 Paper Width Adjusting Tab
- 10 Paper Length Guide
- 11 Paper Length Adjusting Tab
- 12 Paper Size Dial

Components at the Rear of the Printer

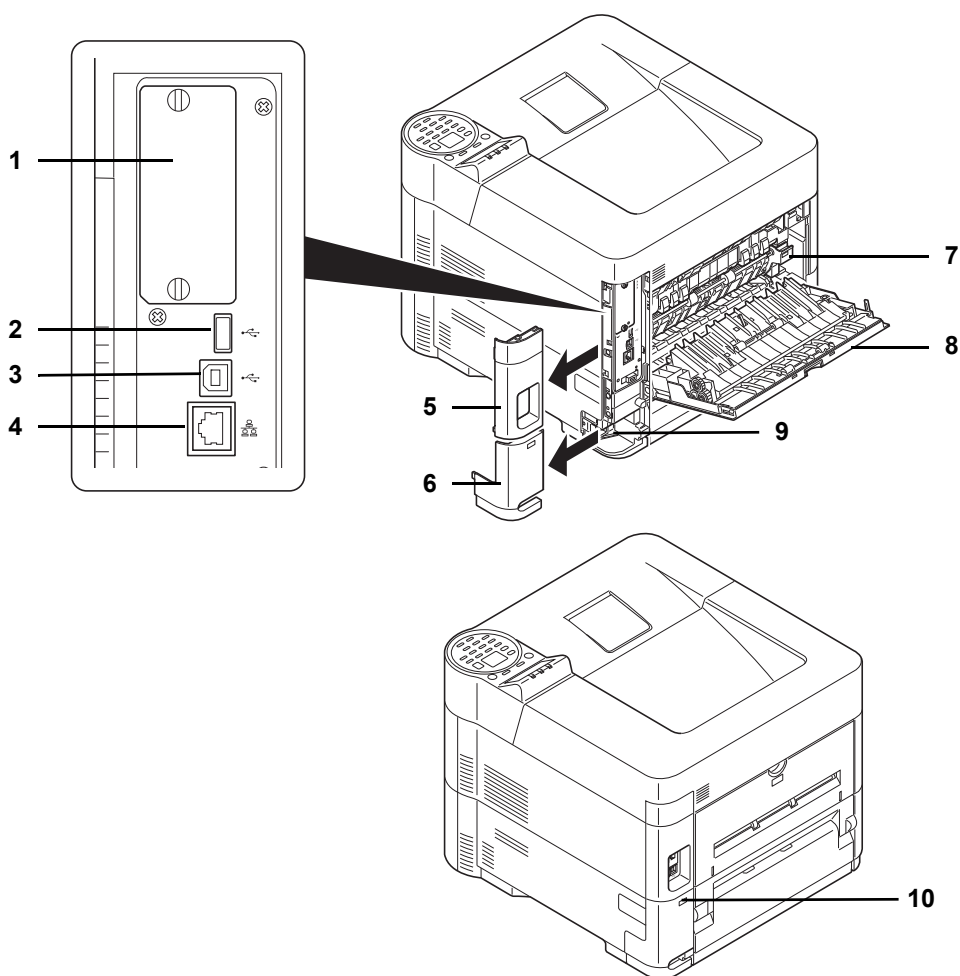

- 1 Option Interface Slot
- 2 Network Interface Connector
- 3 USB Port (For Card Authentication Kit)
- 4 USB Interface Connector
- 5 Interface Cover
- 6 Power Cord Connector Cover
- 7 Fuser Cover
- 8 Rear Cover
- 9 Power Cord Connector
- 10 Anti-theft Lock Slot

Operation Panel

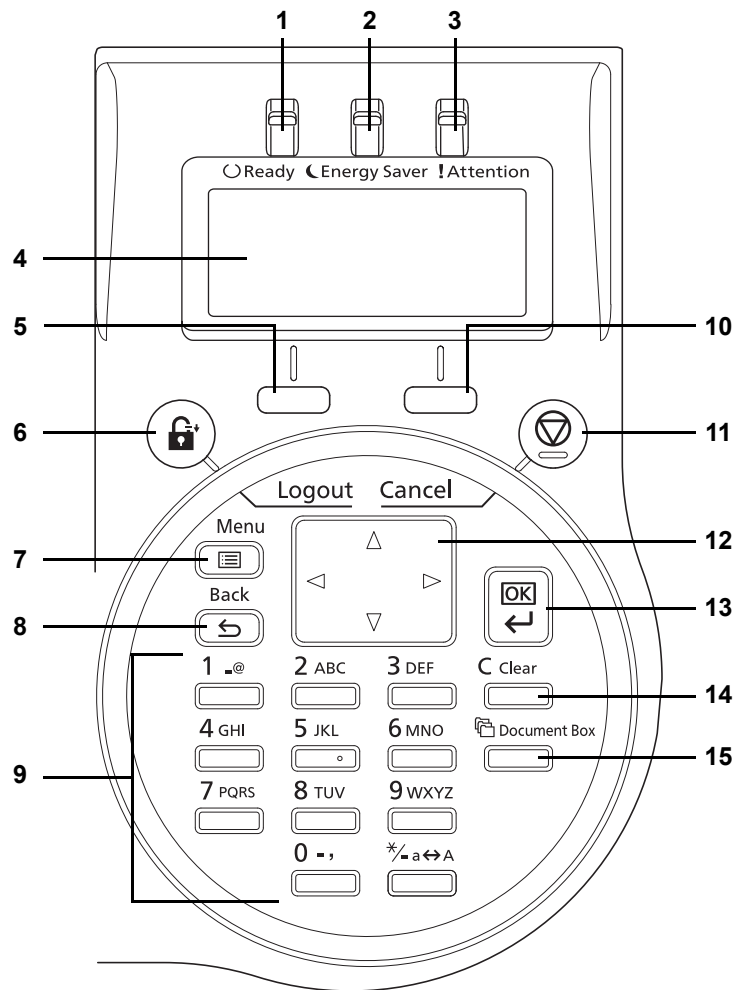

- 1 Ready Indicator
- 2 Energy Saver Indicator
- 3 Attention Indicator
- 4 Message Display
- 5 **[Left Select]** Key
- 6 **[Logout]** Key
- 7 **[Menu]** Key
- 8 **[Back]** Key
- 9 Numeric Keys
- 10 **[Right Select]** Key
- 11 **[Cancel]** Key
- 12 Arrow Keys
- 13 **[OK]** Key
- 14 **[Clear]** Key
- 15 **[Document Box]** Key

2 Preparation before Use

This chapter contains explanations on the following topics:

Changing Network Interface Parameters	2-2
Configuring the Wireless Network	2-7
Setting Wi-Fi Direct	2-12
Printing a Status Page	2-16
Installing Software	2-17
Status Monitor	2-24
Command Center RX	2-28
Power On/Off	2-35
Energy Saver Function	2-36
Loading Paper	2-38

Changing Network Interface Parameters

This printer supports TCP/IP (IPv4), TCP/IP (IPv6), IPP, SSL Server and the IPSec protocols and Security Level.

The table below shows the items required for each of the settings.

Configure the printer's network parameters as appropriate for your PC and your network environment.

Menu	Submenu			Setting		
Network	Wired Netwk. Set	TCP/IP Settings	TCP/IP		On/Off	
			IPv4 Setting	DHCP		On/Off
				Auto-IP		On/Off
				IP Address		IP address
				Subnet Mask		IP address
				Default Gateway		IP address
			IPv6 Setting	IPv6 Setting		On/Off
				Manual Settings	IP Address	IP Address
					Prefix Length	0-128
					Default Gateway	IP Address
		RA(Stateless)		On/Off		
		DHCPv6		On/Off		
		LAN Interface		Auto/10BASE-Half/ 10BASE-Full/ 100BASE-Half/ 100BASE-Full/ 1000BASE-T		
	Protocol Settings	Bonjour	Off/On		On/Off	
		IPSec	Off/On		On/Off	
		NetBEUI	Off/On		On/Off	
		SNMPv3	Off/On		On/Off	
		FTP(Server)	Off/On		On/Off	
		SNMP	Off/On		On/Off	
		SMTP	Off/On		On/Off	
POP3		Off/On		On/Off		
RAW Port		Off/On		On/Off		
LPD		Off/On		On/Off		
IPP		Off/On		On/Off		
		Port Number		1 - 32767		
IPP Over SSL	Off/On		On/Off			

Menu	Submenu			Setting	
Network	Protocol Settings	HTTP	Off/On	On/Off	
		HTTPS	Off/On	On/Off	
		LDAP	Off/On	On/Off	
		ThinPrint	Off/On	On/Off	
			Port Number	1 - 32767	
			ThinPrintOverSSL	On/Off	
		WSD-PRINT	Off/On	On/Off	
		EnhancedWSD (SSL)	Off/On	On/Off	
	Enhanced WSD	Off/On	On/Off		
Restart Network				Yes/No	
Security	Network Security	SSL Setting	SSL	Off/On	On/Off

 **Note** When the network settings have been changed, restart the network card of the device. This is mandatory to make the settings effective. For details, refer to *Restart Network (Restarting the network card)* on page 4-81.

Network Settings

This section explains the settings for when DHCP is used or when an IP Address is entered while TCP(IPv4) is selected. For details of the settings, refer to *Network (Network settings)* on page 4-60. Also, for how to use the Menu Selection System, refer to *Using the Menu Selection System* on page 4-7.

 **Note** When entering an IP Address manually, check the IP Address, Subnet Mask and Default Gateway with the system administrator.

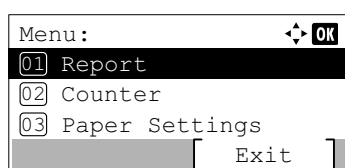

1 While the printer displays Ready to print., Please wait. and Processing., press **[Menu]**. The mode selection menu is displayed.

2 Press Δ or ∇ to select Network.

3 Press **[OK]**. The Network menu screen appears.

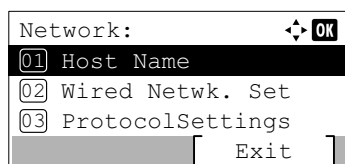

4 Press Δ or ∇ to select Wired Netwk. Set.

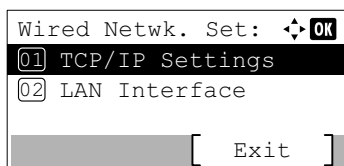

- 5** Press **[OK]**. The Wired Netwk. Set menu screen appears.

Checking that TCP/IP is On

This is an explanation of the method for setting for IPv4, but TCP/IP should also be On when setting for IPv6.

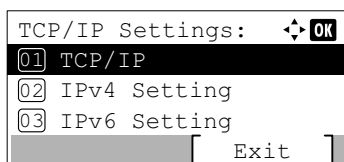

- 6** Select TCP/IP Settings and press **[OK]**. The TCP/IP Settings menu screen appears.

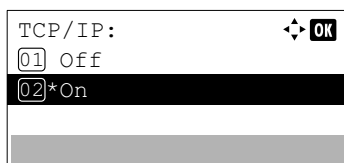

- 7** Press Δ or ∇ to select TCP/IP.
- 8** Press **[OK]**. The TCP/IP screen appears.

- 9** Check that On is selected. If Off is selected, then press Δ or ∇ to select On.



Note "*" is displayed for the setting which has been selected.

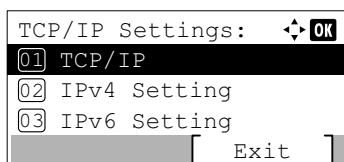

- 10** Press **[OK]**. The TCP/IP setting is set and the TCP/IP Settings menu reappears.

Switching DHCP to Off or On

Select On when using a DHCP server to automatically obtain an IP Address. Select Off to enter an IP Address.

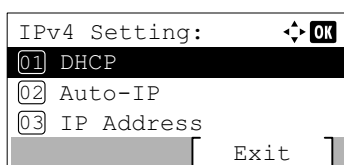

- 11** Press Δ or ∇ to select IPv4 Setting.
- 12** Press **[OK]**. The IPv4 Setting menu screen appears.

- 13** Press Δ or ∇ to select DHCP.

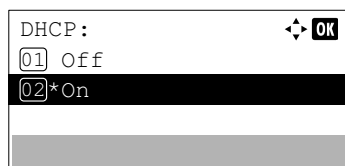

14 Press **[OK]**. The DHCP screen appears.

15 Press Δ or ∇ to select *Off* or *On*.

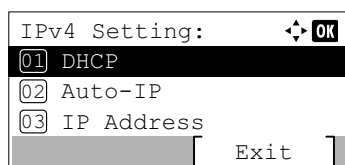

16 Press **[OK]**. The DHCP setting is set and the IPv4 Setting menu reappears.



Note DHCP becomes effective when *On* is selected. Press **[Menu]** to end the mode selection menu.

When *Off* is set, continue on to enter the IP Address.

Entering the IP address

If DHCP is set to *Off*, enter the IP Address manually.

17 Press Δ or ∇ to select *IP Address*.

18 Press **[OK]**. The IP Address screen appears.



19 Use the numeric keys or Δ or ∇ to set the IP address.

You can set any value between 000 and 255.

Increase or reduce the figures by pressing Δ or ∇ .

Use \triangleleft and \triangleright to move the position being entered, which is shown highlighted.

20 Press **[OK]**. The IP address is stored and the IPv4 Setting menu reappears.

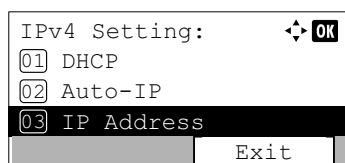

Entering the Subnet Mask

When DHCP is set to *Off*, enter the Subnet Mask manually.

21 Press Δ or ∇ to select *Subnet Mask*.

22 Press **[OK]**. The Subnet Mask screen appears.

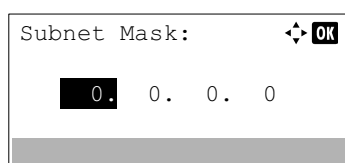

- 23** Use the numeric keys or Δ or ∇ to set the subnet mask.
You can set any value between 000 and 255.
The method for entering is the same as for the IP Address.

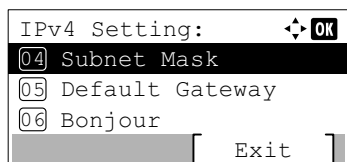

- 24** Press **[OK]**. The subnet mask setting is stored and the IPv4 Setting menu reappears.

Entering the Default Gateway

When DHCP is set to Off, enter the Default Gateway manually.

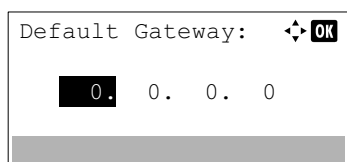

- 25** Press Δ or ∇ to select Default Gateway.
- 26** Press **[OK]**. The Default Gateway screen appears.

- 27** Use the numeric keys or press Δ or ∇ to set the default gateway.
You can set any value between 000 and 255.
The method for entering is the same as for the IP Address.

- 28** Press **[OK]**. The default gateway is stored and the IPv4 Setting menu reappears.

This completes the network settings. Press **[Menu]** and end the mode selection menu.



Note When the network settings have been changed, restart the network card of the device. This is mandatory to make the settings effective. For details, refer to *Restart Network (Restarting the network card)* on page 4-81.

Configuring the Wireless Network

When the Wireless Network Interface Kit (IB-36 and IB-51) is installed on the machine and the connection settings are configured, it is possible to print or send in a wireless network (wireless LAN) environment. The configuration methods are as follows

Configuration Method	Description	Reference Page
Configuring the Connection from the Operation Panel on This Machine	Use Wi-Fi Settings or Wireless Network to configure the network in details from System menu.	Wi-Fi Settings (Wi-Fi Settings)...4-63 Wireless Network (Wireless network settings)...4-83
Setting the Connection by Using the Wi-Fi Setup Tool	This is the tool included in the Product Library. You can configure the connection according to the instructions provided by the wizard.	Setting the Connection by Using the Wi-Fi Setup Tool...2-7
Setting the Connection by Using the Setup Utility of IB-51	This is the setup tool included in the CD of IB-51. You can use it on both Windows and Mac OS.	<i>IB-51 Operation Guide</i>
Configuring Connections on the Web Page	For the IB-51, the connection can be set from the Command Center RX.	<i>Command Center RX User Guide</i>
	For the IB-51, the connection can be set on the dedicated Web page.	<i>IB-51 Operation Guide</i>

 **Note** For detail of the optional Wireless Network Interface Kit (IB-36/IB-51), Contact your dealer or our sales or service representatives.

- Wireless Network Interface Kit (IB-36)...A-8
- Wireless Network Interface Kit (IB-51)...A-7

When you want to switch to the network interface other than Wired (default) after installing an optional Network Interface Kit (IB-50) and a Wireless Network Interface Kit (IB-36 or IB-51), select the desired setting on *Primary Network (Select the network interface to use)* on page 4-80.

Setting the Connection by Using the Wi-Fi Setup Tool

To send the Wi-Fi settings configured in the Wi-Fi Setup Tool to the machine, connect the computer or handheld device with the machine locally. The connection methods are wired connection via LAN cable and wireless LAN connection (Wi-Fi Direct).

 **Note** Before using the Wi-Fi Setup Tool, connect your computer to this machine locally with wired LAN cable or Wi-Fi Direct.

To use Wi-Fi Direct, confirm that the Wi-Fi Direct is enabled (Wi-Fi Direct is set to ON) and Restart Network from the operation panel, before your computer will be connected to this machine with Wi-Fi Direct.

To use a wired LAN cable directly connected to the machine, the Auto-IP (Link-local) address will be assigned to the machine and the computer. This machine applies Auto-IP as the default settings.

Configure the settings on the operation panel if your computer supports WPS.

- Wi-Fi Settings (Wi-Fi Settings)...4-63
- Wireless Network (Wireless network settings)...4-83

Wired Connection by Using LAN Cable

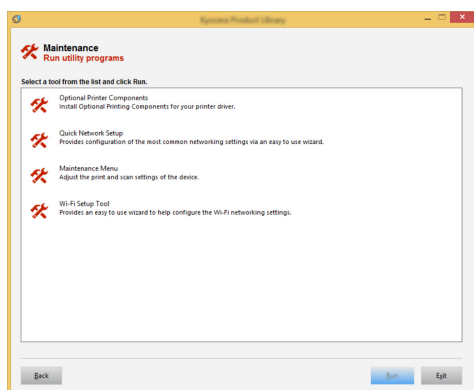
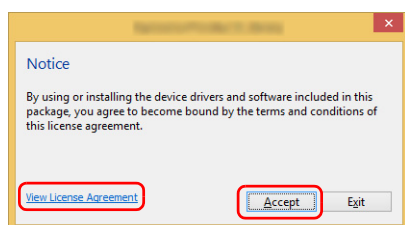
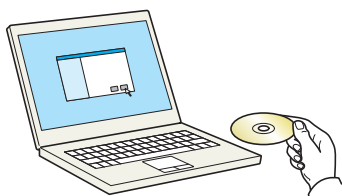

- 1 Connect the machine with a computer via LAN cable when the machine is powered on.
- 2 Turn on the computer.
IP address (link local address) of the machine and computer is generated automatically.
- 3 Insert the *Product Library* disk.



Note Installation on Windows must be done by a user logged on with administrator privileges.

If the **Welcome to the Found New Hardware Wizard** dialog box displays, select **Cancel**.

If the autorun screen is displayed, click **Run setup.exe**.

If the user account management window appears, click **Yes (Allow)**.

- 4 Click **View License Agreement** and read the License Agreement. Click **Accept**.

- 5 Select **Maintenance**.

- 6 Select **Wi-Fi Setup Tool**.

- 7 Click **Run**.

- 8 Select **Do not use automatic configuration**.

- 9 Click **Next** twice.

- 10 Select **Use LAN cable**.

- 11 Click **Next** twice.

- 12 Click **Easy setup**.

- 13 Click **Next**.

The machine is detected.



Note Only one machine can be searched using Wi-Fi Setup Tool. It may take times to search the machine.

If the machine is not detected, select **Advanced setup > Next**. Select **Express** or **Custom** as device discovery method and specify the IP address or host name to search the machine.

- 14** Select the machine.
- 15** Click **Next**.
- 16** Select **Use the device settings.** on **Authentication mode**
- 17** Enter the login user name and password (Login user name and Password are both Admin.), and then click **Next**.
- 18** Configure the communication settings and then click **Next**.
- 19** Change the settings of access point as necessary and then click **Next**.
The network is configured.

LAN Connection by Using Wi-Fi Direct

When the optional Wireless Network Interface Kit (IB-36) is installed in the machine, you can configure connection settings using Wi-Fi Direct.

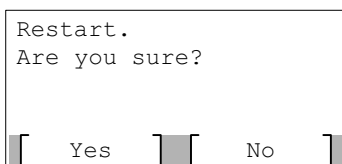
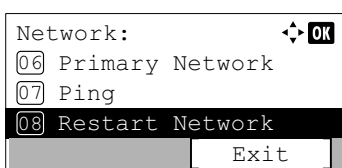
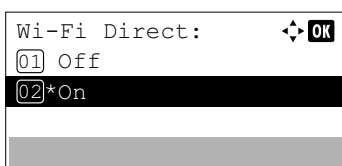
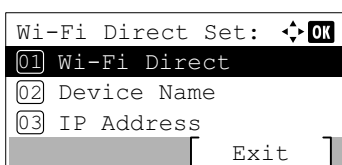
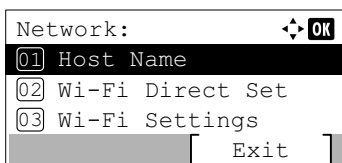

- 1** Press **[Menu]**.
- 2** Press Δ or ∇ to select **Network**.
- 3** Press **[OK]**. The **Network** menu screen appears.
- 4** In the **Network** menu, press Δ or ∇ to select **Wi-Fi Direct Set**.
- 5** Press **[OK]**. The **Wi-Fi Direct Set** menu screen appears.
- 6** In the **Wi-Fi Direct Set** menu, press Δ or ∇ to select **Wi-Fi Direct**.
- 7** Press **[OK]**. The **Wi-Fi Direct** screen appears.
- 8** Press Δ or ∇ to select **On**.
- 9** Press **[OK]**. The **Wi-Fi Direct** setting is set and the **Wi-Fi Direct Set** menu reappears.
- 10** Press **[Back]**. The **Network Set** menu reappears.
- 11** In the **Network** menu, press Δ or ∇ to select **Restart Network**.
- 12** Press **[OK]**. A confirmation screen appears.
- 13** Press **[Yes] ([Left Select])**. The message **Restarting... Please wait.** appears and the network is restarted.

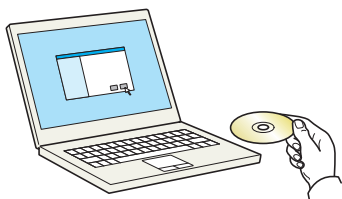

14 Insert the *Product Library* disk.



Note Installation on Windows must be done by a user logged on with administrator privileges.

If the **Welcome to the Found New Hardware Wizard** dialog box displays, select **Cancel**.

If the autorun screen is displayed, click **Run setup.exe**.

If the user account management window appears, click **Yes (Allow)**.

15 Click **View License Agreement** and read the License Agreement.

Click **Accept**.

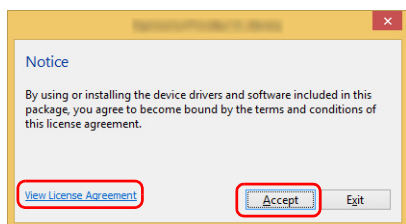

16 Select **Maintenance**.

17 Select **Wi-Fi Setup Tool**.

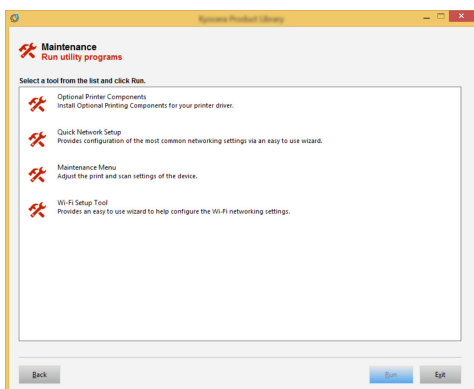

18 Click **Run**.

19 Select **Do not use automatic configuration**.

20 Click **Next** twice.

21 Click **Wi-Fi Direct**.

22 Click **Next** twice.

23 Click **Advanced setup**.

24 Click **Next**.

Select **Express** or **Custom** as device discovery method and specify the IP address or host name to search the machine.

25 Select the machine.

26 Click **Next**.

27 Select **Use the device settings**. on **Authentication mode**

28 Enter the login user name and password (Login user name and Password are both Admin.), and then click **Next**.

29 Configure the communication settings and then click **Next**.

30 Change the settings of access point as necessary and then click **Next**.

The network is configured.

Setting Wi-Fi Direct

If you are using the machine with the optional wireless interface kit attached, setting Wi-Fi Direct enables you to print from the Wi-Fi Direct environment. The configuration methods are as follows:

Configuring the Connection from the Operation Panel on This Machine

Connecting to Computers or Handheld Devices that Support Wi-Fi Direct

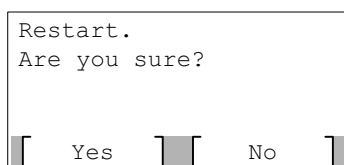
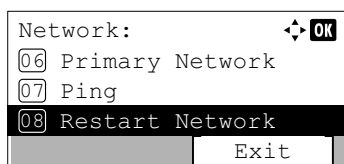
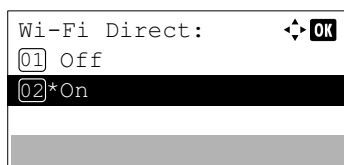
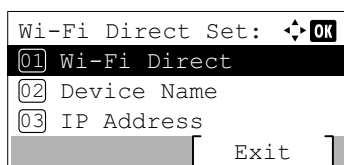
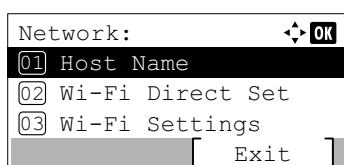

- 1** Press **[Menu]**.
- 2** Press Δ or ∇ to select **Network**.
- 3** Press **[OK]**. The **Network** menu screen appears.
- 4** In the **Network** menu, press Δ or ∇ to select **Wi-Fi Direct Set**.
- 5** Press **[OK]**. The **Wi-Fi Direct Set** menu screen appears.
- 6** In the **Wi-Fi Direct Set** menu, press Δ or ∇ to select **Wi-Fi Direct**.
- 7** Press **[OK]**. The **Wi-Fi Direct** screen appears.
- 8** Press Δ or ∇ to select **On**.
- 9** Press **[OK]**. The **Wi-Fi Direct** setting is set and the **Wi-Fi Direct Set** menu reappears.
- 10** Press **[Back]**. The **Network Set** menu reappears.
- 11** In the **Network** menu, press Δ or ∇ to select **Restart Network**.
- 12** Press **[OK]**. A confirmation screen appears.
- 13** Press **[Yes]** (**[Left Select]**). The message **Restarting... Please wait.** appears and the network is restarted.

14 Specify the machine name from the computer or handheld device.

If a confirmation message appears on the operation panel of the machine, press [Yes] ([Left Select]).

The network between this machine and the handheld device is configured.

Connecting to Computers or Handheld Devices Unsupported Wi-Fi Direct

Here, we'll explain the procedures for connecting to iOS handheld devices.

- 1** Press [Menu].
- 2** Press Δ or ∇ to select Network.
- 3** Press [OK]. The Network menu screen appears.

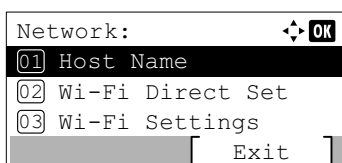

- 4** In the Network menu, press Δ or ∇ to select Wi-Fi Direct Set.
- 5** Press [OK]. The Wi-Fi Direct Set menu screen appears.

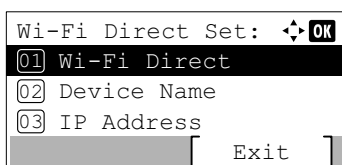

- 6** In the Wi-Fi Direct Set menu, press Δ or ∇ to select Wi-Fi Direct.
- 7** Press [OK]. The Wi-Fi Direct screen appears.

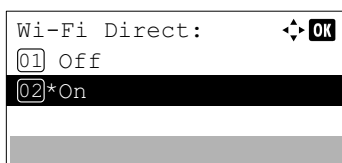

- 8** Press Δ or ∇ to select On.
- 9** Press [OK]. The Wi-Fi Direct setting is set and the Wi-Fi Direct Set menu reappears.

10 Press [Back]. The Network Set menu reappears.

11 In the Network menu, press Δ or ∇ to select Restart Network.

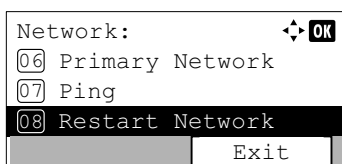

12 Press [OK]. A confirmation screen appears.

13 Press [Yes] ([Left Select]). The message Restarting... Please wait. appears and the network is restarted.

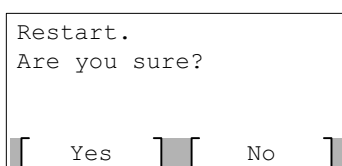

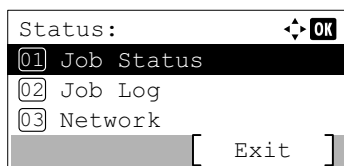

14 Press [Status] ([Left Select]). The Status menu screen appears.

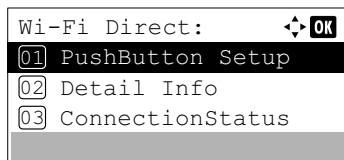

15 In the Status menu, press Δ or ∇ to select Wi-Fi Direct.

16 Press [OK]. The Wi-Fi Direct menu is displayed.

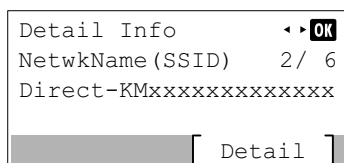

17 In the Wi-Fi Direct menu, press Δ or ∇ to select Detail Info.

18 Press [OK]. The Detail Info screen appears.

Note the network name (SSID), IP address, and password.

19 Select Settings > Wi-Fi on your mobile device.

20 Select the network name (SSID) appeared in step 18 from the list.

21 Enter the password that was provided in step 18.

22 Press [Connect].

The network between this machine and the handheld device is configured.

Configuring the Connection by Using Push Button

When your computer or handheld device does not support Wi-Fi Direct but supports WPS, you can configure the network using push button.

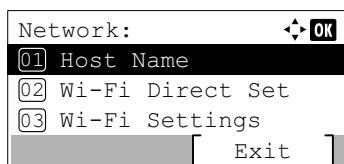

1 Press [Menu].

2 Press Δ or ∇ to select Network.

3 Press [OK]. The Network menu screen appears.

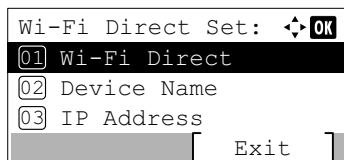

4 In the Network menu, press Δ or ∇ to select Wi-Fi Direct Set.

5 Press [OK]. The Wi-Fi Direct Set menu screen appears.

6 In the Wi-Fi Direct Set menu, press Δ or ∇ to select Wi-Fi Direct.

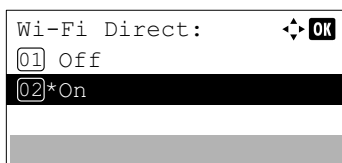

7 Press **[OK]**. The `Wi-Fi Direct` screen appears.

8 Press Δ or ∇ to select `On`.

9 Press **[OK]**. The `Wi-Fi Direct` setting is set and the `Wi-Fi Direct Set` menu reappears.

10 Press **[Back]**. The `Network Set` menu reappears.

11 In the `Network` menu, press Δ or ∇ to select `Restart Network`.

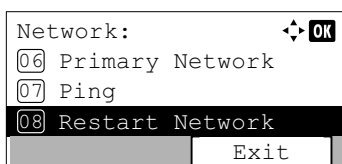

12 Press **[OK]**. A confirmation screen appears.

13 Press **[Yes]** (**[Left Select]**). The message `Restarting... Please wait.` appears and the network is restarted.

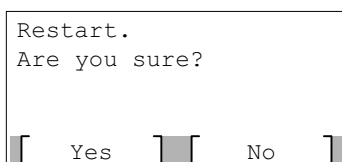

14 Press **[Status]** (**[Left Select]**). The `Status` menu screen appears.

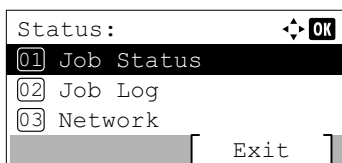

15 In the `Status` menu, press Δ or ∇ to select `Wi-Fi Direct`.

16 Press **[OK]**. The `Wi-Fi Direct` menu is displayed.

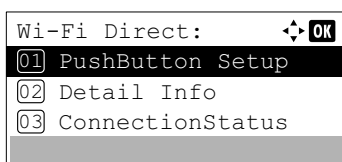

17 In the `Wi-Fi Direct` menu, press Δ or ∇ to select `PushButton Setup`.

18 Press **[OK]**. A confirmation message is displayed.

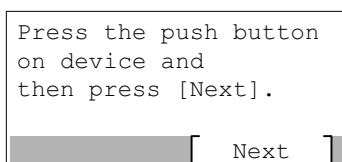

19 Press the push button on the computer or handheld device.

20 Press [Next] ([Right Select]).

The network between this machine and the computer or handheld device is configured.

IMPORTANT You can connect up to three handheld devices at the same time using Wi-Fi Direct setting. When the devices that support Wi-Fi Direct are connected, if you want to connect other device, disconnect the alreadyconnected devices from the network. The disconnection methods are as follows:

- Disconnect the network from the computer or handheld computer
- Disconnecting all devices from the network on the operation panel (ConnectionStatus...6-7)
- Configuring auto disconnecting time from the System menu (Disconnect Timer (Setting the Disconnect Time)...4-63)
- Configuring auto disconnecting time from the Command Center RX (*Command Center RX User Guide*)

Printing a Status Page

After completing the network settings, print a status page. The status page allows you to confirm a range of information, including network addresses and network protocols.

To print a status page, select `Report Print` from the Report menu, and then select `Status Page`. Refer to *Report Print on page 4-10* for detailed information.

Installing Software

Install appropriate software on your PC from the included DVD (*Product Library*) if you want to use the printer function of this machine from your PC.

Software

You can use either **Express Install** or **Custom Install** can be selected for the installation method. **Express Install** is the standard installation method. To install components that cannot be installed by **Express Install**, use **Custom Install**.

For details, refer to Custom Installation in the *Custom Install on page 2-19*.

Software	Description	Express Install
Printing System Driver	This driver enables files on a computer to be printed by the machine. Multiple page description languages (PCL XL, KPDL, etc.) are supported by a single driver. This printer driver allows you to take full advantage of the features of the machine. Use this driver to create PDF files.	<input type="radio"/>
KX XPS DRIVER	This printer driver supports the XPS (XML Paper Specification) format developed by Microsoft Corporation.	—
KPDL mini-driver/PCL mini-driver	This is a Microsoft MiniDriver that supports PCL and KPDL. There are some restrictions on the machine features and option features that can be used with this driver.	—
KYOCERA Net Viewer	This is a utility that enables monitoring of the machine on the network.	—
Status Monitor	This is a utility that monitors the printer status and provides an ongoing reporting function.	<input type="radio"/>
KYOCERA Net Direct Print	This makes it possible to print a PDF file without starting Adobe Acrobat/Reader.	—
FONTS	These are display fonts that enable the machine's built-in fonts to be used in a software application.	<input type="radio"/>



Note

- Installation on Windows must be done by a user logged on with administrator privileges.
- KX XPS DRIVER cannot be installed on Windows XP.

Installing Printer Driver in Windows

Express Install

The following procedure is an example for installing the software in Windows 8.1 using **Express Install**.

For details, refer to Custom Installation in the *Custom Install on page 2-19*.

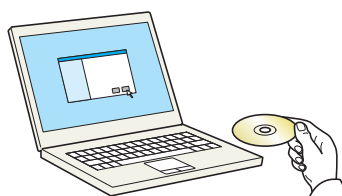

- 1 Insert the *Product Library* disk.



Note Installation on Windows must be done by a user logged on with administrator privileges.

If the **Welcome to the Found New Hardware Wizard** dialog box displays, select **Cancel**.

If the autorun screen is displayed, click **Run setup.exe**.

If the user account management window appears, click **Yes (Allow)**.

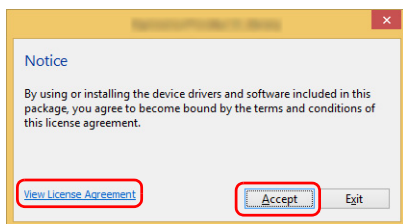



- Click **View License Agreement** and read the License Agreement. Click **Accept**.

- Select **Express Install** tab.

- Select the device to be installed.

You can also select **Use host name for port name** and set to use the host name of the standard TCP/IP port. (A USB connection cannot be used.)

IMPORTANT If Wi-Fi or Wi-Fi Direct is enabled, be sure to specify the IP address for the port name. Installation may fail if the host name is specified.

 **Note** The machine cannot be detected unless it is on. If the computer fails to detect the machine, verify that it is connected to the computer via a network or USB cable and that it is turned on and click  (Reload).

- Select the features you want to use with this device.

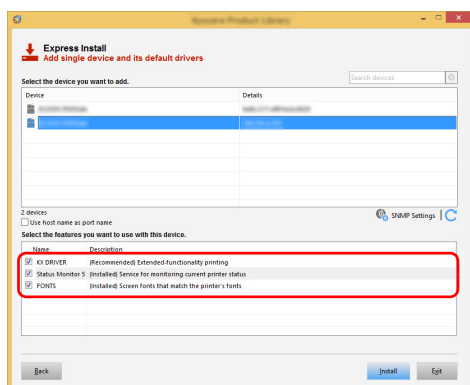
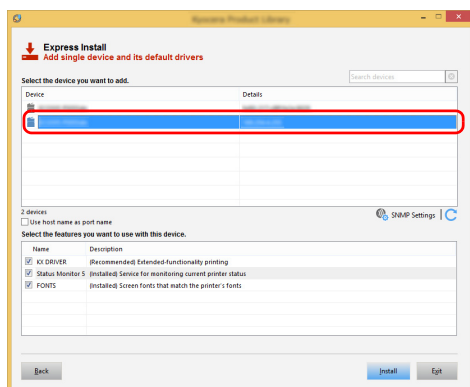

- Click **Install**.

 **Note** If the Windows security window appears, click **Install this driver software anyway**.

To install Status Monitor, it is necessary to install Microsoft .NET Framework 4.0 beforehand.

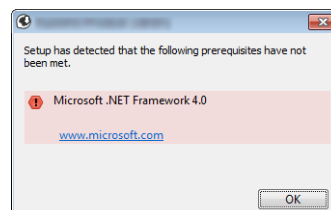

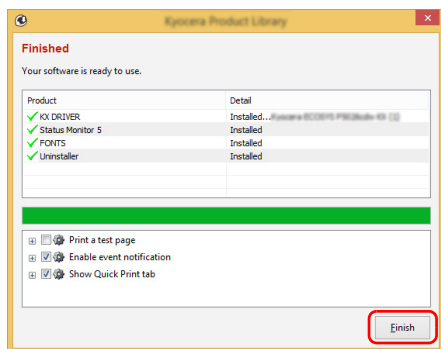

7 Finish the installation.

When **Your software is ready to use** appears, you can use the software. To print a test page, click the **Print a test page** checkbox and select the machine.

Click **Finish** to exit the wizard.



Note When you have selected **Device settings** in Windows XP, the dialog box for device setting will appear after **Finish** is clicked. Configure the settings for options installed on the machine. Device settings can be configured after the installation is completed.

For more information, refer to the *Printer Driver User Guide*.

If a system restart message appears, restart the computer by following the screen prompts. This completes the printer driver installation procedure.

Custom Install

The following procedure is an example for installing the software in Windows 8.1 using **Custom Install**.

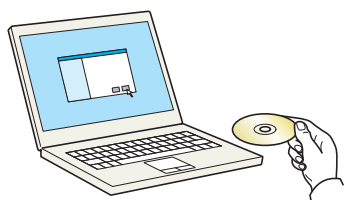

1 Insert the *Product Library* disk.



Note Installation on Windows must be done by a user logged on with administrator privileges.

If the **Welcome to the Found New Hardware Wizard** dialog box displays, select **Cancel**.

If the autorun screen is displayed, click **Run setup.exe**.

If the user account management window appears, click **Yes (Allow)**.

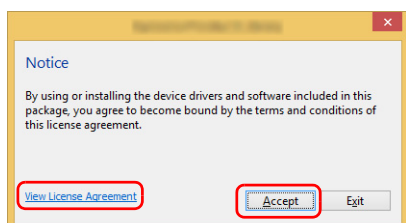

2 Click **View License Agreement** and read the License Agreement. Click **Accept**.

3 Select **Custom Install** tab.

4 Select the device to be installed, and click the arrow button to move it to the **Products to Install** list.

IMPORTANT If Wi-Fi or Wi-Fi Direct is enabled, be sure to specify the IP address for the port name.

Installation may fail if the host name is specified.



Note The machine cannot be detected unless it is on. If the computer fails to detect the machine, verify that it is connected to the computer via a network or USB cable and that it is turned on and click **Reload** (C).

If the desired device does not appear, select **Add custom device** to directly select the device.

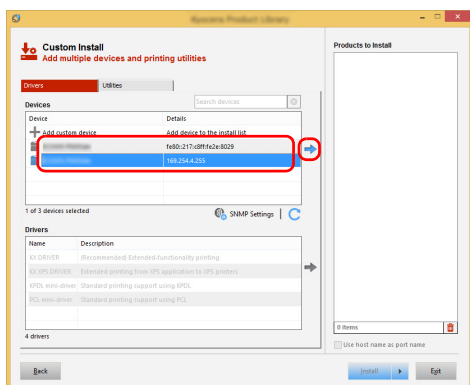

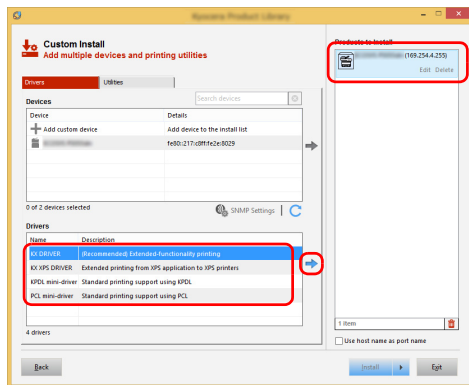

- 5 Select the driver to be installed, and then click the arrow button to move it to the **Products to Install** list.

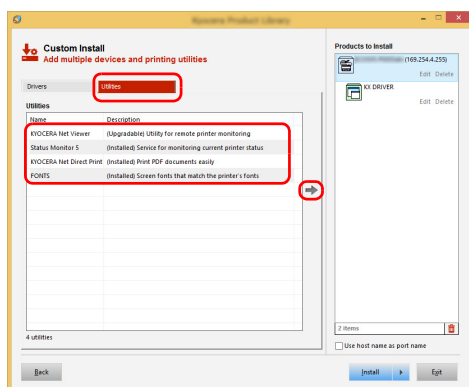

- 6 Click **Utility** tab and select the utility to be installed.

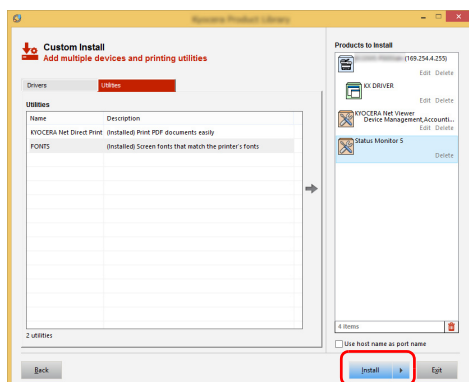

- 7 Click **Install**.



Note To install Status Monitor, it is necessary to install Microsoft .NET Framework 4.0 beforehand.

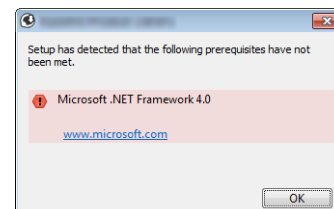

- 8 Finish the installation.

When **Your software is ready to use** appears, you can use the software. To print a test page, click the **Print a test page** checkbox and select the machine.

Click **Finish** to exit the wizard.



Note When you have selected **Device settings** in Windows XP, the dialog box for device setting will appear after **Finish** is clicked. Configure the settings for options installed on the machine. Device settings can be configured after the installation is completed.

For more information, refer to the *Printer Driver User Guide*.

If a system restart message appears, restart the computer by following the screen prompts. This completes the printer driver installation procedure.

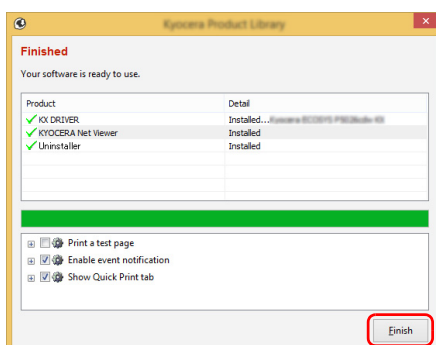

Uninstalling the Software

Perform the following procedure to delete the Software from your computer.



Note Uninstallation on Windows must be done by a user logged on with administrator privileges.

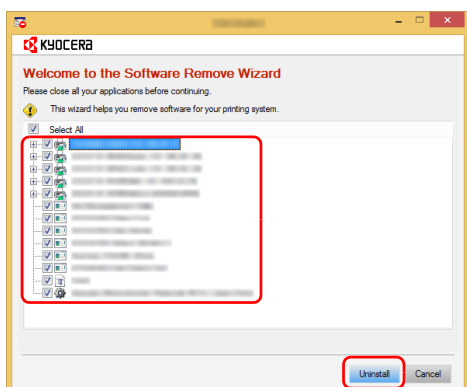

- 1 Click **Search** in charms, and enter **Uninstall Kyocera Product Library** in the search box. Select **Uninstall Kyocera Product Library** in the search list.



Note In Windows 7, click **Start** button on the Windows and then select **All Programs, Kyocera, and Uninstall Kyocera Product Library** to display the Uninstall Wizard.

- 2 Place a check in the check box of the software to be deleted. Click **Uninstall**.

- 3 If a system restart message appears, restart the computer by following the screen prompts. This completes the software uninstallation procedure.



Note The software can also be uninstalled using the *Product Library* disk.

In the Product Library installation screen, click **Uninstall**, and follow the on-screen instructions to uninstall the software.

Installing Printer Driver in Macintosh

The machine's printer functionality can be used by a Macintosh computer.

The following is an explanation for installation in MAC OSX 10.9.



Note Installation on MAC OS must be done by a user logged on with administrator privileges.

When printing from a Macintosh computer, set the machine's emulation to **KPDL** or **KPDL(Auto)**. For details, refer to *Emulation (Setting the emulation)* on page 4-48.

If connecting by Bonjour, enable Bonjour in the machine's network settings. For details, refer to *ProtocolSettings (Detailed settings for the network protocol)* on page 4-78.

In the Authenticate screen, enter the name and password used to log in to the operating system.

When printing via AirPrint, you do not have to install the software.

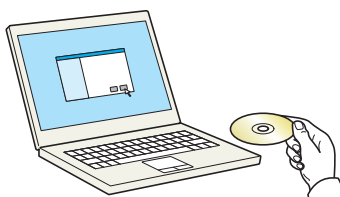

- 1 Insert the *Product Library* disk.

2 Double-click the **Kyocera** icon.

3 Double-click **OS X 10.5 or higher** .

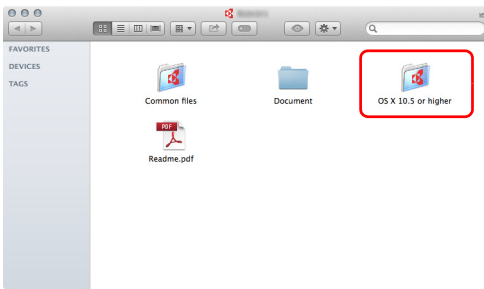

4 Double-click **Kyocera OS X x.x.**

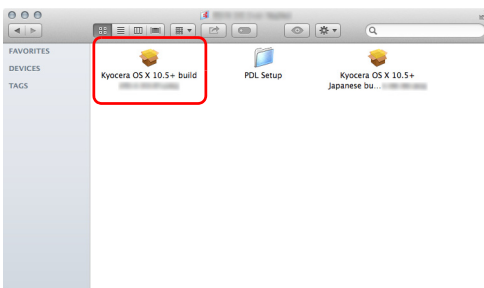

5 The printer driver installation program starts up.



6 Install the printer driver as directed by the instructions in the installation software.

This completes the printer driver installation.

If a USB connection is used, the machine is automatically recognized and connected.

If an IP connection is used, the settings below are required.

7 Open System Preferences and click **Printers & Scanners**.

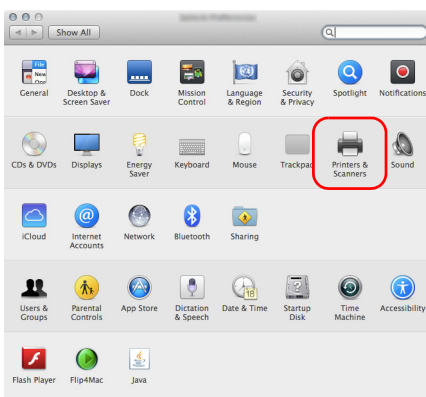

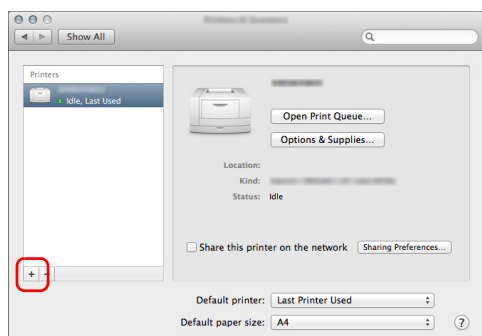

8 Click the plus symbol (+) to add the installed printer driver.

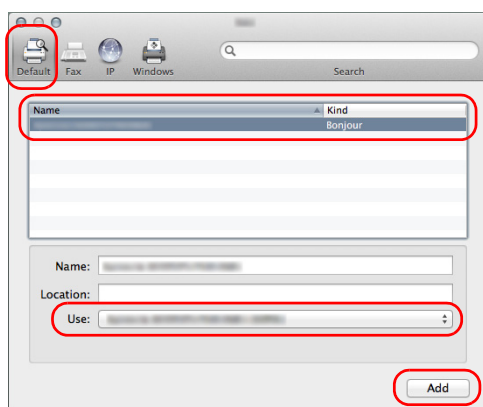

9 Select **Default** and click the item that appears in **Name**.

Select the driver in **Use** and click **Add**.

 **Note** When using an IP connection, click the **IP** icon for an IP connection and then enter the IP address and printer name. The number entered in **Address** will automatically appear in **Name**. Change if needed.

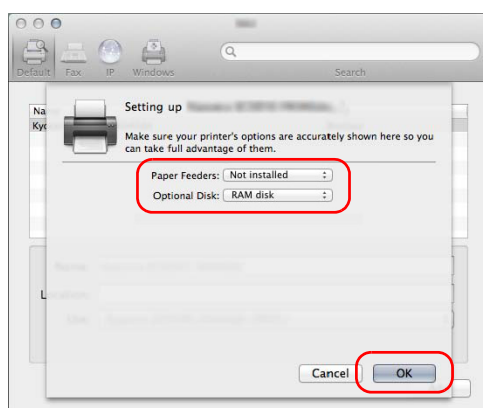

10 Select the options available for the machine and click **OK**.

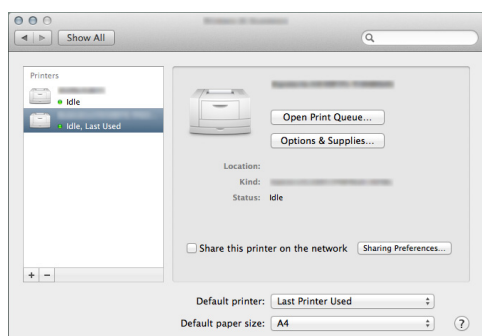

11 The selected printer is added.

Status Monitor

The Status Monitor monitors the printer status and provides an ongoing reporting function.

 **Note** When you activate Status Monitor, check the status below.

- Printing System Driver is Installed.
- Either `Enhanced WSD` or `EnhancedWSD (SSL)` are set to `On` in *Protocol/Settings (Detailed settings for the network protocol)* on page 4-78.

Accessing the Status Monitor

The Status Monitor also starts up when printing is started.

Exiting the Status Monitor

Use either of the methods listed below to exit the Status Monitor.

- Exit manually:
Click the settings icon and select **Exit** in the menu to exit the Status Monitor.
- Exit automatically:
The Status Monitor automatically shuts down after 7 minutes if it is not being used.

Status Monitor Display

The display of the Status Monitor is as follows.

Quick View State

The status of the printer is displayed using icons. Detailed information is displayed when the Expand button is clicked.

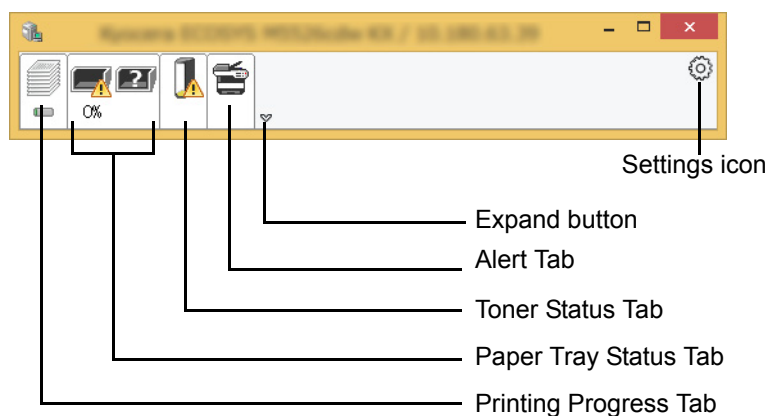

Detailed information is displayed by clicking on each icon tab.

Printing Progress Tab

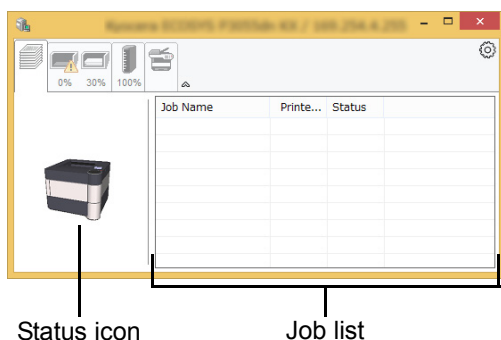

The status of the print jobs is displayed.

Select a job on the job list and it can be canceled using the menu displayed with a right-click.

Paper Tray Status Tab

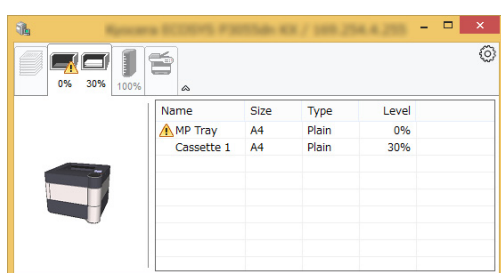

Information is displayed about the paper in the printer and about the amount of paper remaining.

Toner Status Tab

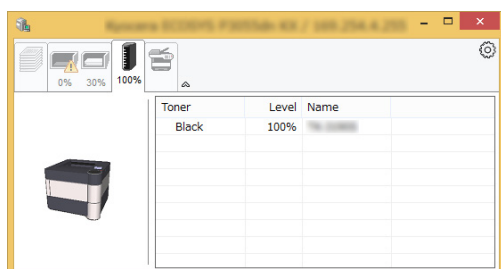

The amount of toner remaining is displayed.

Alert Tab

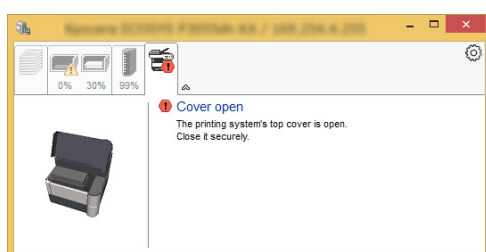

If an error occurs, a notice is displayed using a 3D image and a message.

Status Monitor Context Menu

The following menu is displayed when the settings icon is clicked.

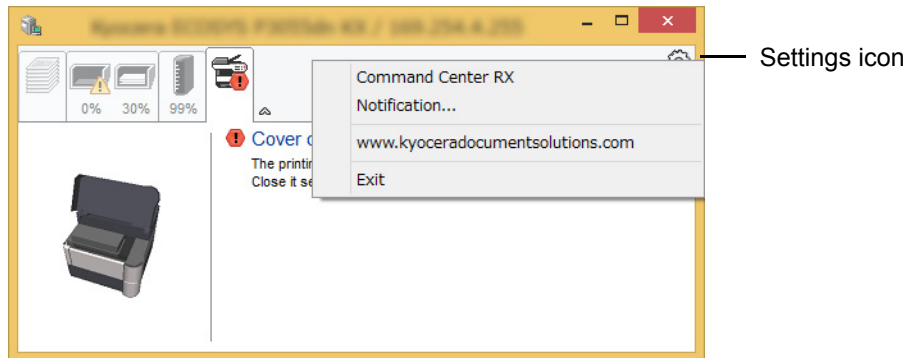

- **Command Center RX**
If the printer is connected to a TCP/IP network and has its own IP address, use a web browser to access the Command Center RX to modify or confirm the network settings. For more information, refer to the *Command Center RX User Guide*.
This menu is not displayed when using USB connection.
- **Notification...**
This sets the display of the Status Monitor. For details, refer to *Status Monitor Notification Settings on page 2-27*.
- **www.kyoceradocumentsolutions.com**
Open our website.
- **Exit**
Exits the Status Monitor.

Status Monitor Notification Settings

The Status Monitor settings and event list details are displayed.

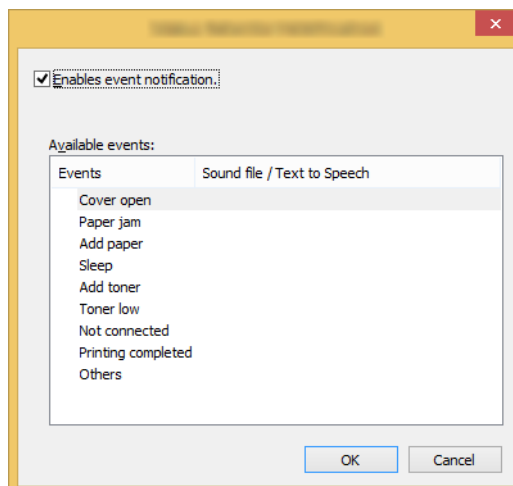

Select whether notification is performed when an error in the event list occurs.

1 Select **Enable event notification**.

If this setting is set to Off, then the Status Monitor will not start up even when printing is executed.

2 Select an event to use with the text to speech function in **Available events**.

3 Click **Sound file / Text to Speech** column.

Click the browse (...) button to notify the event by sound file.



Note The available file format is WAV.

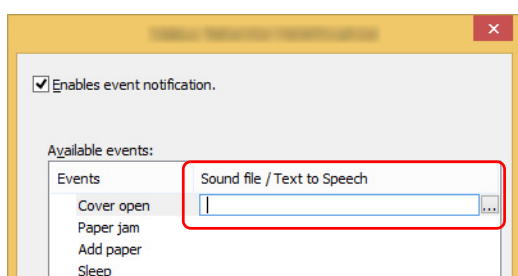

When customizing the message texts to read on the screen aloud, enter the texts in the text box.

Command Center RX

If the machine is connected to the network, you can configure various settings using Command Center RX.

This section explains how to access Command Center RX, and how to change security settings and the host name. For details on Command Center RX, refer to the *Command Center RX User Guide*.

 **Note** To fully access the features of the Command Center RX pages, enter the User Name and Password and click **Login**. Entering the predefined administrator password allows the user to access all pages, including Document Box and Settings on the navigation menu. The factory default setting for the default user with administrator privileges is shown below.

Login User Name: **Admin**

Login Password: **Admin**

* Upper case and lower case letters are distinguished (case sensitive).

Settings that the administrator and general users can configure or check in Command Center RX are as follows.

Setting	Description	Administ- rator	General User
Device Information	The machine's structure can be checked.	<input type="radio"/>	<input type="radio"/>
Job Status	Displays all device information, including print jobs and job log history.	<input type="radio"/>	<input type="radio"/>
Document Box	Add or delete document boxes, or delete documents within a document box.	<input type="radio"/>	<input type="radio"/> †
Device Settings	Configure the advanced settings of the machine.	<input type="radio"/>	—
Function Settings	Configure the advanced function settings.	<input type="radio"/>	—
Network Settings	Configure the network advanced settings.	<input type="radio"/>	—
Security Settings	Configure the security advanced settings.	<input type="radio"/>	—
Management Settings	Configure the advanced management settings.	<input type="radio"/>	—

† The logged in user may not be able to configure some settings, depending on the permissions of the user.

Accessing Command Center RX

1 Launch your Web browser.

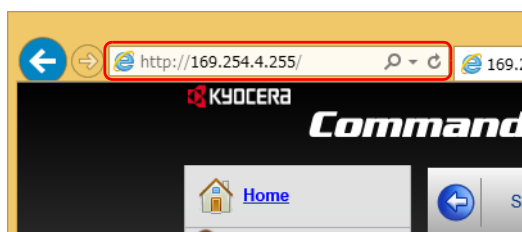

2 In the address or location bar, enter the machine's IP address or the host name.



Note Print the status page to check the machine's IP address and the host name. For details, refer to *Status Page (Printing a printer's status page)* on page 4-12.

Examples: `https://10.180.81.2/` (for IP address)

`https://DEVICE001` (if the host name is "DEVICE001")

The web page displays basic information about the machine and Command Center RX as well as their current status.

 **Note** If the screen **There is a problem with this website's security certificate.** is displayed, configure the certificate. For details on Certificates, refer to the *Command Center RX User Guide*.

You can also continue the operation without configuring the certificate.

- 3 Select a category from the navigation bar on the left of the screen.

 **Note** To fully access the features of the Command Center RX pages, enter the User Name and Password and click **Login**. Entering the predefined administrator password allows the user to access all pages, including Document Box and Settings on the navigation menu. The factory default setting for the default user with administrator privileges is shown below.

Login User Name: **Admin**

Login Password: **Admin**

* Upper case and lower case letters are distinguished (case sensitive).

Changing Security Settings

This section explains how to change the security settings.

- 1 Launch your Web browser.

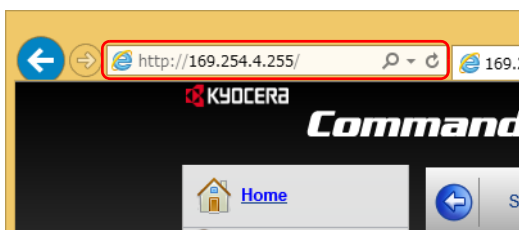

- 2 In the address or location bar, enter the machine's IP address or the host name.

 **Note** Print the status page to check the machine's IP address and the host name. For details, refer to *Status Page (Printing a printer's status page)* on page 4-12.

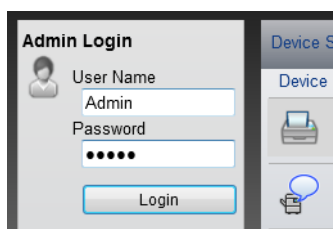

- 3 Log in with administrator privileges.

The factory default setting for the default user with administrator privileges is shown below.

Login User Name: **Admin**

Login Password: **Admin**

* Upper case and lower case letters are distinguished (case sensitive).

- 4 From the **Security Settings** menu, select the setting you want to configure.

 **Note** The configurable settings within **Device Security** and **Network Security** can also be configured from the machine's operation panel. For details, refer to *Operation Panel on page 4-1*.

For details on settings related to certificates, refer to the *Command Center RX User Guide*.

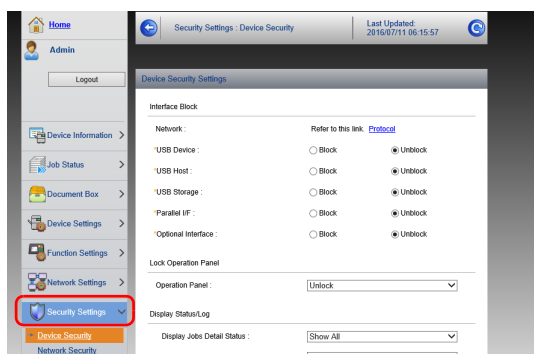

Changing Device Information

Change the device information of the machine.

- 1 Launch your Web browser.

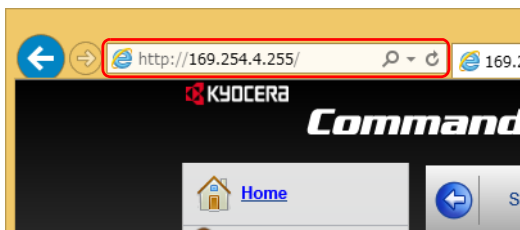

- 2 In the address or location bar, enter the machine's IP address or the host name.



Note Print the status page to check the machine's IP address and the host name. For details, refer to *Status Page (Printing a printer's status page)* on page 4-12.

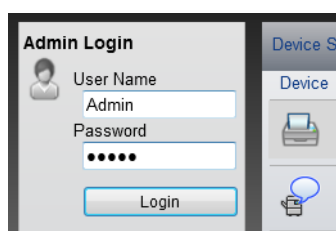

- 3 Log in with administrator privileges.

The factory default setting for the default user with administrator privileges is shown below.

Login User Name: **Admin**

Login Password: **Admin**

* Upper case and lower case letters are distinguished (case sensitive).

- 4 From the **Device Settings** menu, select **System**.

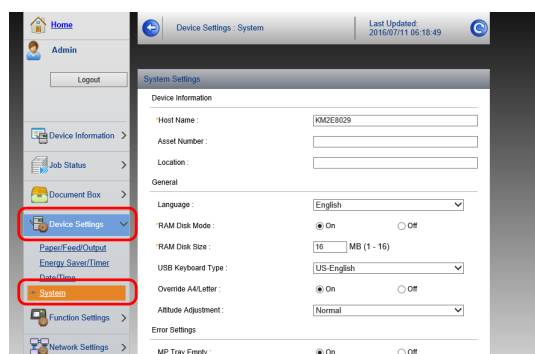

- 5 Enter the device information, and then click **Submit**.

IMPORTANT After changing the setting, restart the network or turn the machine OFF and then ON.

To restart the network interface card, click **Reset** in the **Management Settings** menu, and then click **Restart Network in Restart**.

E-mail Settings

Specifying the SMTP settings allows you to send notification of the end of a Job via E-mail.

To use this function, this machine must be connected to a mail server using the SMTP protocol.

In addition, configure the following.

- SMTP settings
Item: **SMTP Protocol** and **SMTP Server Name** in **SMTP**
- The sender address when the machine sends E-mails
Item: **Sender Address** in **E-mail Send Settings**
- The setting to limit the size of E-mails
Item: **E-mail Size Limit** in **E-mail Send Settings**

The procedure for specifying the SMTP settings is explained below.

- 1 Launch your Web browser.

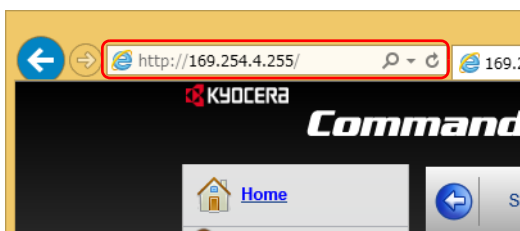

- 2 In the address or location bar, enter the machine's IP address or the host name.



Note Print the status page to check the machine's IP address and the host name. For details, refer to *Status Page (Printing a printer's status page)* on page 4-12.

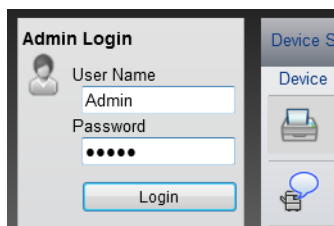

- 3 Log in with administrator privileges.

The factory default setting for the default user with administrator privileges is shown below.

Login User Name: **Admin**

Login Password: **Admin**

- * Upper case and lower case letters are distinguished (case sensitive).

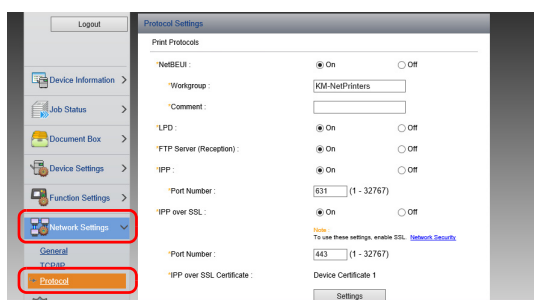

- 4 From the **Network Settings** menu, click **Protocol**.

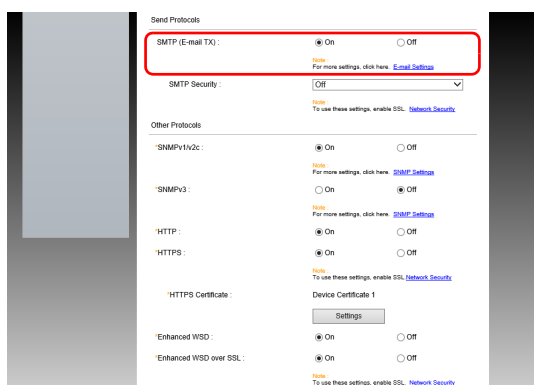

- 5 Set **SMTP (E-mail TX)** to **On** in the **Send Protocols**.

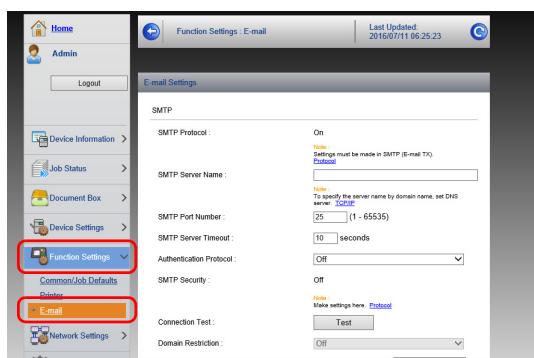

- 6 From the **Function Settings** menu, click **E-mail**.

7 Enter "SMTP" and "E-mail Send Settings" items.

Setting	Description	
SMTP	Set to send e-mail from the machine.	
SMTP Protocol	Displays the SMTP protocol settings. Check that SMTP Protocol is set to On . If Off is set, click Protocol and set the SMTP protocol to On .	
SMTP Server Name[†]	Enter the host name or IP address of the SMTP server.	
SMTP Port Number	Specify the port number to be used for SMTP. Use the SMTP default port 25.	
SMTP Server Timeout	Set the amount of time to wait before time-out in seconds.	
Authentication Protocol	To use SMTP authentication, enter the user information for authentication.	
SMTP Security	Set SMTP security. Turn on SMTP Security in SMTP (E-mail TX) on the Protocol Settings page.	
POP before SMTP Timeout	Specify the time in seconds until the connection to the POP server times out. This can be set when POP before SMTP is selected in Authentication Protocol .	
Connection Test	Tests to confirm that the settings are correct.	
Domain Restriction	To restrict the domains, click the Domain List and enter the domain names of addresses to be allowed or rejected. Restriction can also be specified by e-mail address.	
POP3	You don't need to set the following items when you only enable the function of sending e-mail from the machine. Set the following items if you want to enable the function of receiving e-mail on the machine. For more information, refer to <i>Command Center RX User Guide</i> .	
POP3 Protocol		
Check Interval		
Run once now		
Domain Restriction		
POP3 User Settings		
E-mail Send Settings	E-mail Size Limit	Enter the maximum size of E-mail that can be sent in kilobytes. When E-mail size is greater than this value, an error message appears and E-mail sending is cancelled. Use this setting if you have set E-mail Size Limit for SMTP server. If not, enter a value of 0 (zero) to enable E-mail sending regardless of the size limit.
	Sender Address[†]	Specify the sender address for when the machine sends E-mails, such as the machine administrator, so that a reply or non-delivery report will go to a person rather than to the machine. The sender address must be entered correctly for SMTP authentication. The maximum length of the sender address is 128 characters.
	Signature	Enter the signature. The signature is free form text that will appear at the end of the E-mail body. It is often used for further identification of the machine. The maximum length of the signature is 512 characters.
	Function Defaults	Change the function default settings in Common/Job Default Settings page.

[†] Be sure to enter the items.

8 Click **Submit**.

Creating a New Custom Box

You can register a custom box from Command Center RX.

 **Note** To use Custom Box, an optional SSD must be installed in the machine.

- 1 Launch your Web browser.

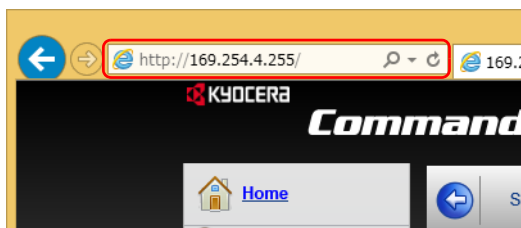

- 2 In the address or location bar, enter the machine's IP address or the host name.

 **Note** Print the status page to check the machine's IP address and the host name. For details, refer to *Status Page (Printing a printer's status page)* on page 4-12.

- 3 From the **Document Box** menu, click **Custom Box**.

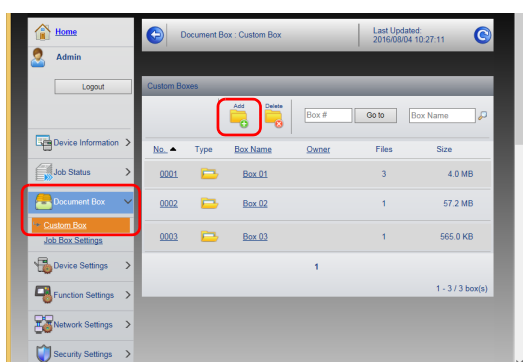

- 4 Click **Add**.

- 5 Enter the box details.

Enter the information for the custom box you want to register. For details on the fields to populate, refer to *Command Center RX User Guide*.

- 6 Click **Submit**.

Printing a Document Stored in a Custom Box

A document stored in a Custom Box can be printed from Command Center RX.

- 1 Launch your Web browser.

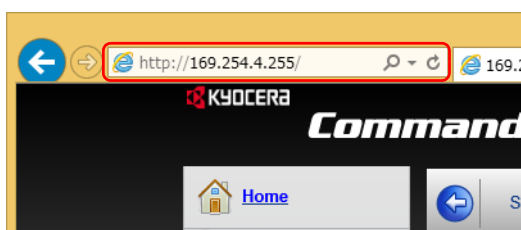

- 2 In the address or location bar, enter the machine's IP address or the host name.

 **Note** Print the status page to check the machine's IP address and the host name. For details, refer to *Status Page (Printing a printer's status page)* on page 4-12.

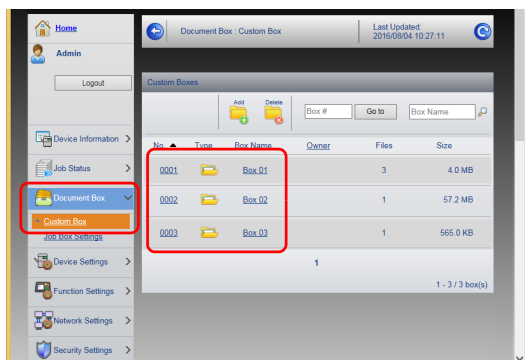

3 From the **Document Box** menu, click **Custom Box**.

4 Click the number or name of the Custom Box in which the document is stored.

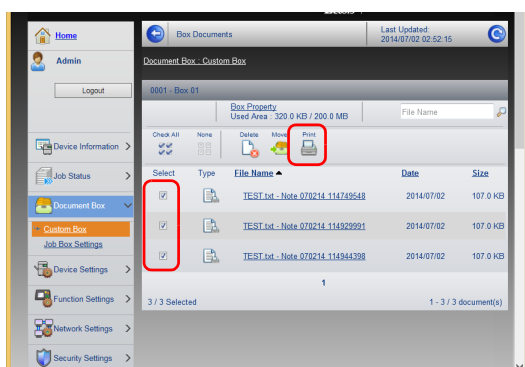

5 Select the checkbox of the document to be printed.

6 Click **Print**.

For settings that are configurable, refer to *Command Center RX User Guide*.

Power On/Off

Power On

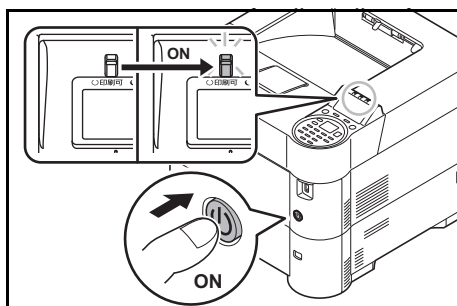

- 1 Press the Power switch.

IMPORTANT When turning off the power switch, do not turn on the power switch again immediately. Wait more than 5 seconds, and then turn on the power switch.

Power Off

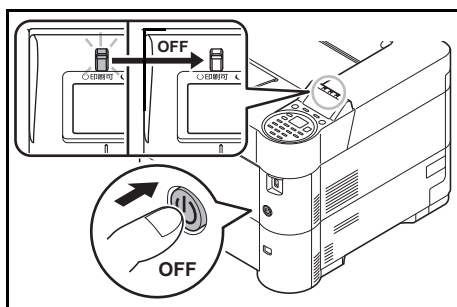

- 1 Press the Power switch.

The confirmation message for power supply off is displayed.
It takes about 3 minutes for power off.

Energy Saver Function

Sleep

For Europe

When the set time (factory setting is 1 minute) elapses after the printer is last used, the printer automatically enters sleep mode. The message display backlight and lights turn off to minimize power consumption. This status is referred to as Sleep.

To use the printer, press **[OK]**. The printer will be ready to use within 18 seconds.

For more information about configuring settings, refer to *Sleep Timer (Sleep timer timeout time)* on page 4-110.

Except for Europe

When the set time (factory setting is 1 minute) elapses after the printer is last used, the printer automatically enters sleep mode. The message display backlight and lights turn off to minimize power consumption. This status is referred to as Sleep.

There are two sleep modes: Quick Recovery and Energy Saver. The default setting is Energy Saver mode.

Quick Recovery Mode

The recovery from the sleep mode is faster than when using Energy Saver mode.

The message display goes off when sleep mode is entered and the **Ready** indicator flashes.

The machine recovers quickly when **[OK]** is pressed. The machine also automatically recovers and prints when a job is detected.

If print data is received during Sleep, the print job is performed while the message display remains unlit.

To use the printer, press **[OK]**.

Note that ambient environmental conditions, such as ventilation, may cause the machine to respond more slowly.

For more information about configuring settings, refer to *Sleep Timer (Sleep timer timeout time)* on page 4-110.

Energy Saver Mode

This mode reduces power consumption even more than quick recovery mode, and allows Sleep mode to be set separately for each function.

IMPORTANT Cautions when setting the Energy Saver mode

- An ID card is not recognized when in Energy Saver mode.

To use the printer, press **[OK]**.

Recovery time from Sleep Mode is as follows.

- ECOSYS P3055dn/ECOSYS P3060dn: 25 seconds or less
- ECOSYS P3050dn: 20 seconds or less
- ECOSYS P3045dn: 15 seconds or less

For more information on Energy Saver settings, refer to *Sleep Level Set. (Sleep level setting)* on page 4-108.

Power Off Timer (for Europe)

If the printer is not used while in sleep mode, the power automatically turns off. The Power Off Timer is used to set the time until the power turns off. The factory setting for the time until the power turns off is 3 days.

IMPORTANT You can set the power off rule and power off timer. For details, refer to *Power Off Rule (Power Off Rule setting) (for Europe)* on page 4-110 and *Power Off Timer (Power off timer settings) (for Europe)* on page 4-111.

In case of not using the printer for an extended period of time



CAUTION If this printer will be left unused for an extended period (e.g. overnight), turn it off at the power switch. If the printer will not be used for an even longer period of time (e.g. vacation), remove the power plug from the outlet as a safety precaution.

CAUTION Remove paper from the cassettes and seal it in the paper storage bag to protect it from humidity.

Loading Paper

The following explains the procedure for loading paper in the cassette and the MP tray.

Loading Paper into the Cassette

The cassettes can hold plain paper, recycled paper or color paper.

Cassette 1 to 5 hold up to 500 sheets of plain paper (80 g/m²).

For details of the supported paper sizes, refer to *Selecting the Right Paper on page A-13*. For the paper type setting, refer to *Media Type (Setting the cassette paper type) on page 4-37*.

IMPORTANT You should not use inkjet printer paper or any paper with a special surface coating. (Such papers may cause paper jams or other faults.)

The cassettes can hold paper with weight between 60 - 120 g/m².

Do not load thick paper that is heavier than 120 g/m² in the cassettes. Use the multi purpose tray for paper that is heavier than 120 g/m².

Place the cassette in a stable place such as on a desk when loading paper.

 **Note** A6 can only be used in Cassette 1 of the ECOSYS P3050dn/ECOSYS P3055dn/ECOSYS P3060dn.
B6 and Postcard cannot be used in Cassette 1 of the ECOSYS P3045dn.

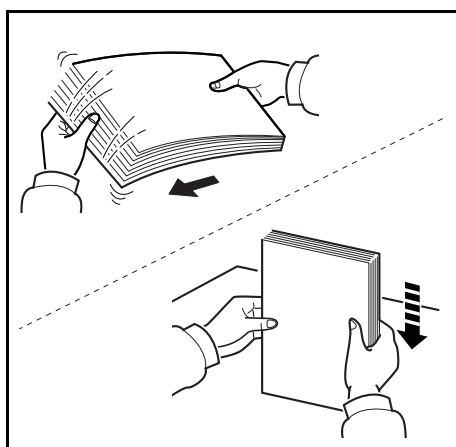

- 1** Fan the media (paper/transparencies), then tap it on a level surface to avoid media jams or skewed printing.

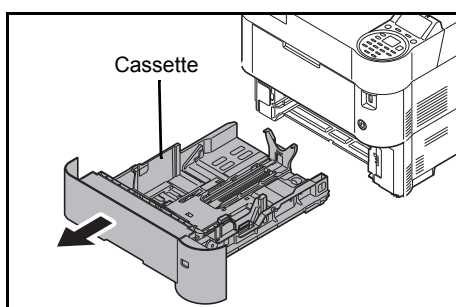

- 2** Pull out the cassette from the machine.
IMPORTANT When pulling out the cassette from the machine, ensure that it is supported and does not fall out.

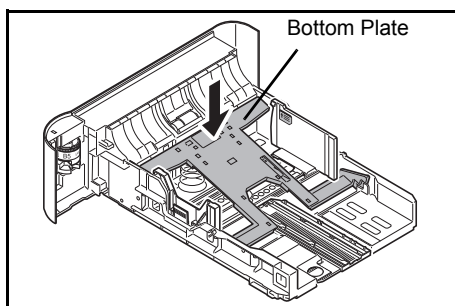

- 3** (On ECOSYS P3045dn only) Press the bottom plate down until it locks.

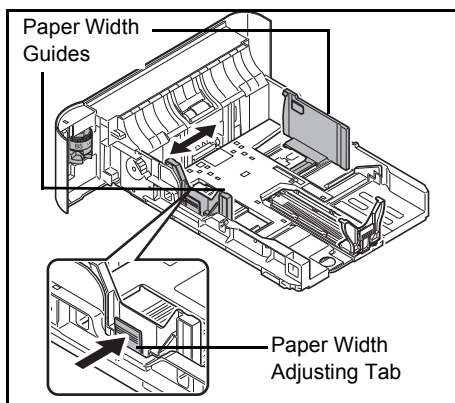

- 4** Adjust the position of the paper width guides located on the left and right sides of the cassette. Press the paper width adjusting tab and slide the guides to the paper size required.

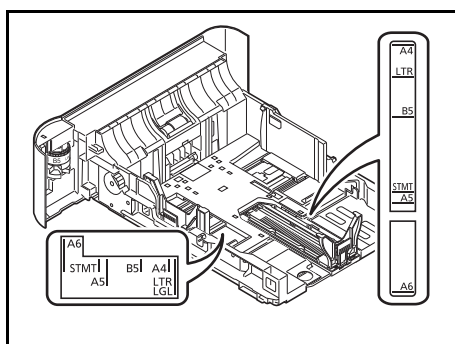

Note Paper sizes are marked on the cassette.

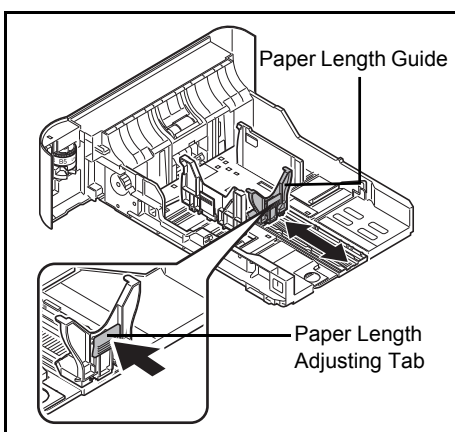

- 5** Adjust the paper length guide to the paper size required.

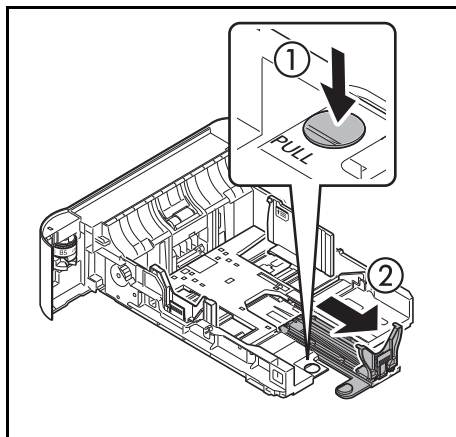

If you are going to use paper that is longer than A4-R, pull the cassette out until it stops at the back and then adjust the paper length guide to the paper size required.

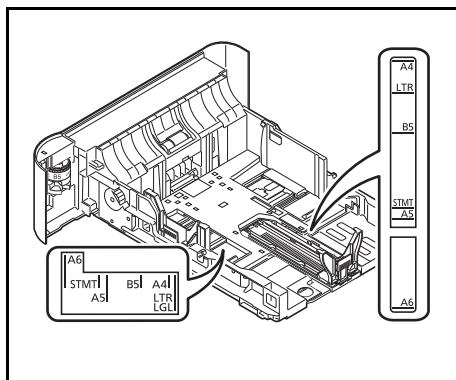

Note Paper sizes are marked on the cassette.

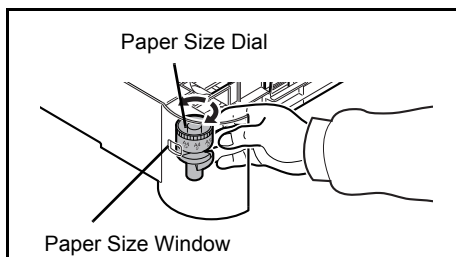

6 Turn the Paper Size Dial so that the size of the paper you are going to use appears in the Paper Size Window.



Note When the Paper Size Dial is set to **Other** the paper size must be set into the printer on the operation panel. Refer to *Cassette (1 to 5) Set. (Settings for the cassettes)* on page 4-32.

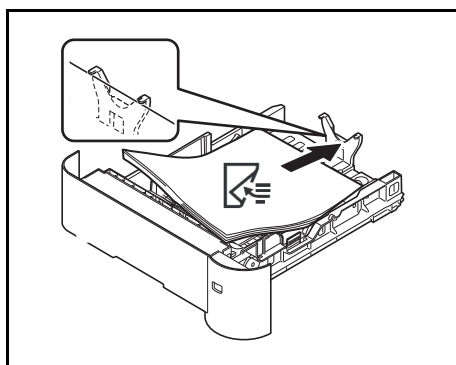

7 Load the paper in the cassette.

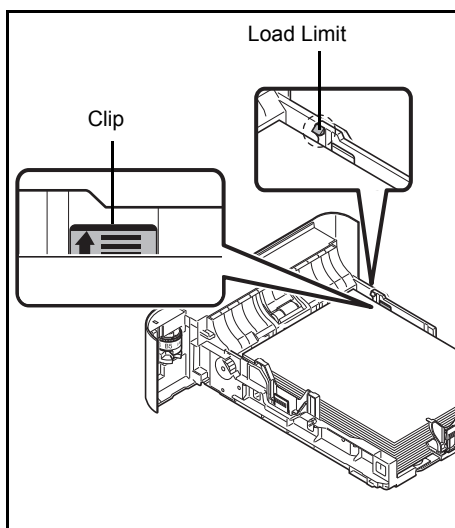

IMPORTANT Load the paper with the print side facing down.

Before loading the paper, be sure that it is not curled or folded. Paper that is curled or folded may cause paper jams.

Ensure that the loaded paper does not exceed the load limit (see the illustration on the left).

Set the stack of paper so that it is under the clips (see the illustration on the left).

The paper length and width guides must be adjusted to the paper size. Loading the paper without adjusting these guides may cause skewed feeding and paper jams.

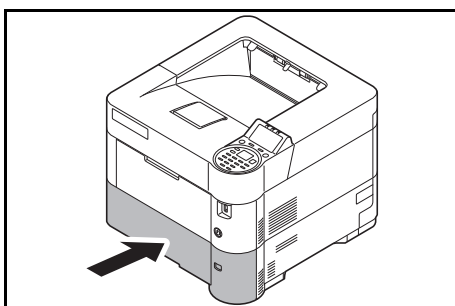

- 8 Insert the paper cassette into the slot in the machine. Push it straight in as far as it will go.



Note If the machine will not be used for a prolonged period, protect all paper from humidity by removing it from the cassettes and sealing it in the paper storage bag.

- 9 Select the media type (plain, recycled, etc.) loaded in the cassette. (Refer to *Media Type (Setting the cassette paper type)* on page 4-33.)

Loading Paper into the MP (Multi-Purpose) Tray

The multi purpose tray will hold up to 100 sheets of A4 plain paper (80 g/m²).

For details of the supported paper sizes, refer to *Selecting the Right Paper on page A-13*. For the paper type setting, refer to *Media Type (Paper type setting for the MP tray) on page 4-31*.

IMPORTANT When using media types other than plain paper (such as recycled paper), always specify the media type setting. If you are using a paper weight of 106 g/m² or more, set the media type to Thick and set the weight of the paper you are using.

The capacity of the multi purpose tray is as follows.

- A4 plain paper (80 g/m²): 100 sheets
- Hagaki: 1 sheet
- Envelope DL, Envelope C5, Envelope #10, Envelope #9, Envelope #6, Envelope Monarch, Youkei 4, Youkei 2: 5 sheets
- Folio: 20 sheets
- Thick paper: 5 sheets

 **Note** When you load custom size paper, select *Custom size* by referring to *Paper Size (Paper size setting for the MP tray) on page 4-30*.

When you use special paper such as envelopes or thick paper, select the media type by referring to *Media Type (Paper type setting for the MP tray) on page 4-31*.

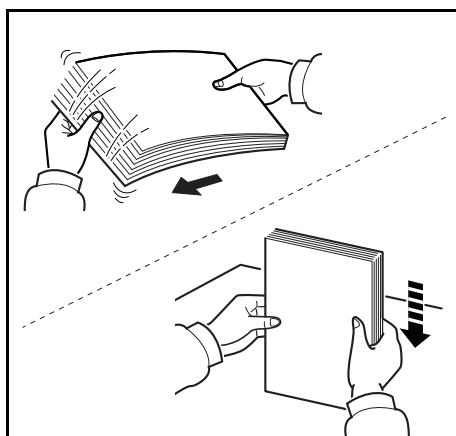

- 1** Fan the media (paper/transparencys), then tap it on a level surface to avoid media jams or skewed printing.

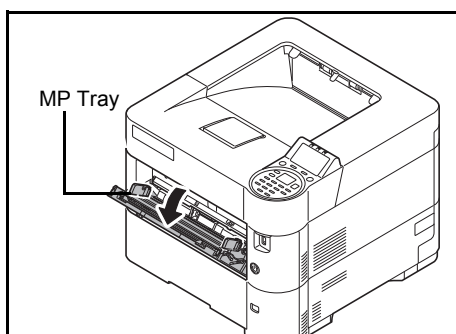

- 2** Pull the MP tray towards you until it stops.

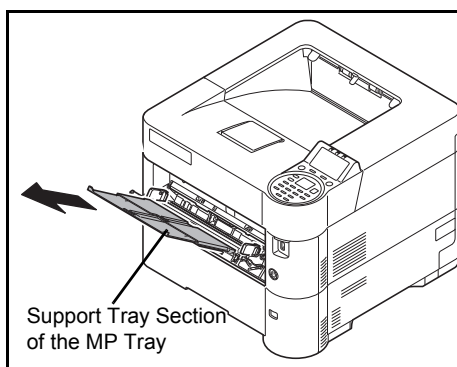

- 3** Pull out the support tray section of the MP tray.

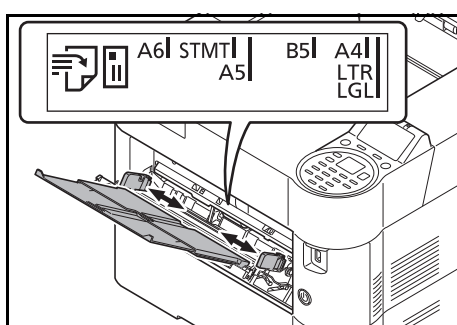

- 4** Adjust the position of the paper guides on the MP tray. Standard paper sizes are marked on the MP tray. For standard paper sizes, slide the paper width guides to the corresponding mark.

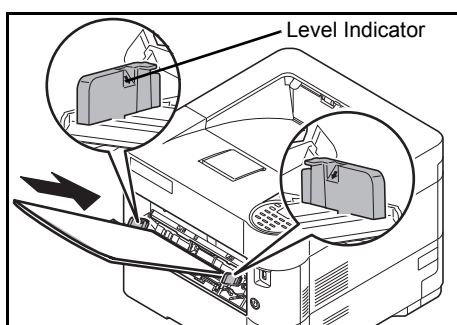

- 5** Align the paper with the paper guides and insert as far as it will go.

IMPORTANT When loading the paper, keep the print side facing up.

Curled paper must be uncurled before use.

When loading paper into the multi purpose tray, check that there is no paper left over in the tray from a previous job before loading the paper. If there is just a small amount of paper left over in the multi purpose tray and you want to add more, first remove the left-over paper from the tray and include it with the new paper before loading the paper back into the tray.

If there is a gap between the paper and the paper width guides, readjust the guides to fit the paper in order to prevent skewed feeding and paper jams.

Ensure that the loaded paper does not exceed the level indicator.

- 6** Set the MP tray paper size on the printer's operation panel. Refer to *MP Tray Set. (MP tray settings)* on page 4-30.

Loading Envelopes

5 envelopes may be loaded in the multi purpose tray.
Acceptable envelope sizes are as follows.

Acceptable Envelope	Size
Youkei 2	114 × 162 (mm)
Youkei 4	105 × 235 (mm)
Envelope Monarch	3 7/8" × 7 1/2"
Envelope #10	4 1/8" × 9 1/2"
Envelope DL	110 × 220 (mm)
Envelope C5	162 × 229 (mm)
Executive	7 1/4" × 10 1/2"
Envelope #9	3 7/8" × 8 7/8"
Envelope #6	3 5/8" × 6 1/2"

When you load envelopes or Hagaki (cardstock) in the multi purpose tray

Load envelope with the print side facing up. For the procedure for printing, refer to the *Printer Driver User Guide*.

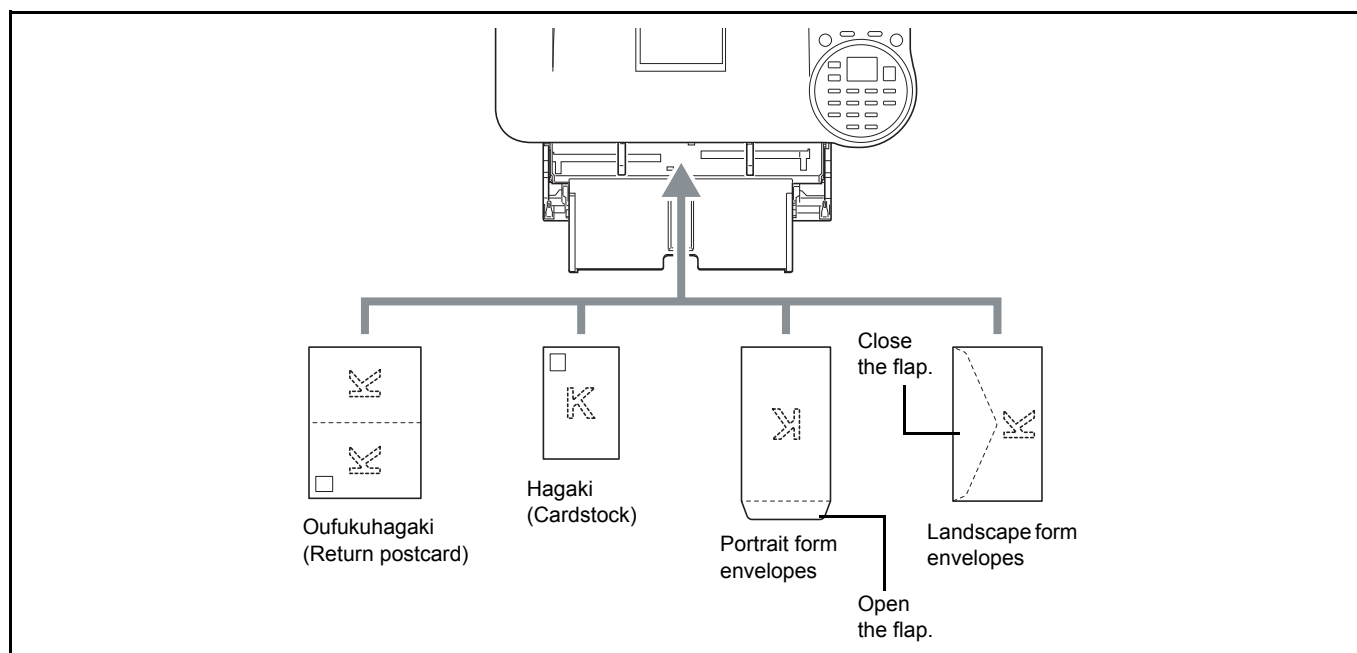

IMPORTANT Use unfolded Oufukuhagaki (return postcard).

How to load envelopes (orientation and facing) will differ depending on the type of envelope. Be sure to load it in correctly, otherwise printing may be done in the wrong direction or on the wrong face.

 **Note** When you load envelopes in the multi purpose tray, select the envelope type by referring to *Media Type (Paper type setting for the MP tray)* on page 4-31.

When you load envelopes in the bulk feeder

You can load envelopes in the bulk feeder (PF-3100). How to load envelopes (orientation and facing) is same as that of loading in the multi purpose tray.

Paper stopper

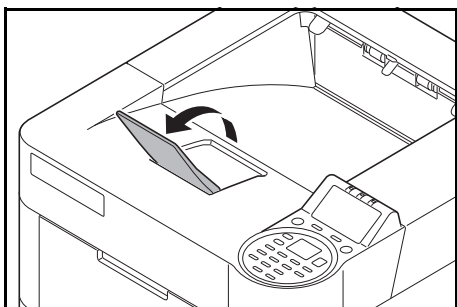

When using paper larger than A4-R/Letter-R, open the paper stopper as shown in the figure.

3 Printing

This chapter contains explanations on the following topics:

Printing from Applications	3-2
Canceling a Printing Job	3-2
Printer Driver Print Settings Screen	3-3
Printing on Non-standard Sized Paper	3-4
Banner Printing	3-5
Printer Driver Help	3-7
Printing Functions	3-8

Printing from Applications

This section provides basic instructions for printing documents. Instructions are based on interface elements as they appear in Windows 8.1. To print the document from applications, install the printer driver on your computer from the supplied *Product Library* disk.

 **Note** Refer to *Installing Software* on page 2-17.

Follow the steps below to print documents from applications.

- 1 Create a document using an application.
- 2 Select **Print** in the application menu. The **Print** dialog box appears.
- 3 Click the ▼ next to the Name field and select this machine from the list.
- 4 Enter the desired print quantity in the **Number of copies** box. Enter any number up to 999.
When there is more than one page, select Collate to print out one by one in the sequence of the page numbers.
- 5 Click **Properties**. The **Properties** dialog box appears.
- 6 Select the **Basic** tab and click **Print size** to select the print size.
To print on the special paper such as thick paper or transparency, click **Media type** menu and select the media type.
- 7 Click **Source** and select the paper source.
 **Note** If you choose **Auto source selection**, paper is supplied automatically from the paper source loaded with paper of optimum size and type. To print on special paper such as envelopes or thick paper, place it on the multi purpose tray and select **MP Tray**.
- 8 Select paper orientation, either Portrait or Landscape, to match the orientation of the document.
- 9 Click **OK** to return to the **Print** dialog box.
- 10 Click **OK** to start printing.

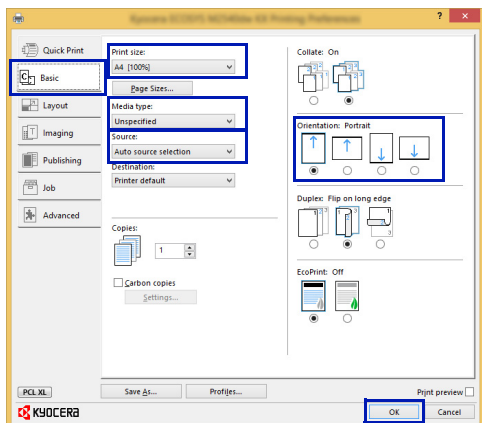

Canceling a Printing Job

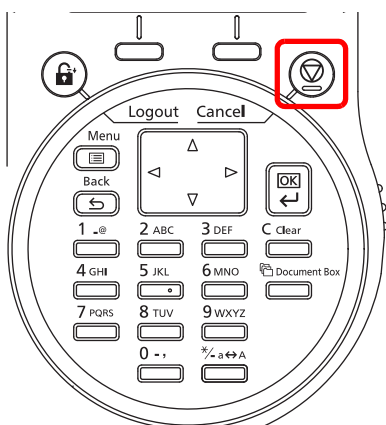

- 1 While the printer displays *Processing.*, press **[Cancel]**.
The *Job Cancel List* appears, showing the list of current print jobs.
- 2 Press ▲ or ▼ to display the desired job and then press **[OK]**.
When the *Job will be canceled. Are you sure?* message appears, press **[Yes]** (**[Left Select]**) to cancel the job or **[No]** (**[Right Select]**) to cancel this operation and continue printing.
When you cancel a job, *Canceling...* appears on the message display and printing stops after the page currently printing has been fed output.

Printer Driver Print Settings Screen

The printer driver print settings screen allows you to configure a variety of print-related settings. For more information, refer to the *Printer Driver User Guide* on the *Product Library* disk.

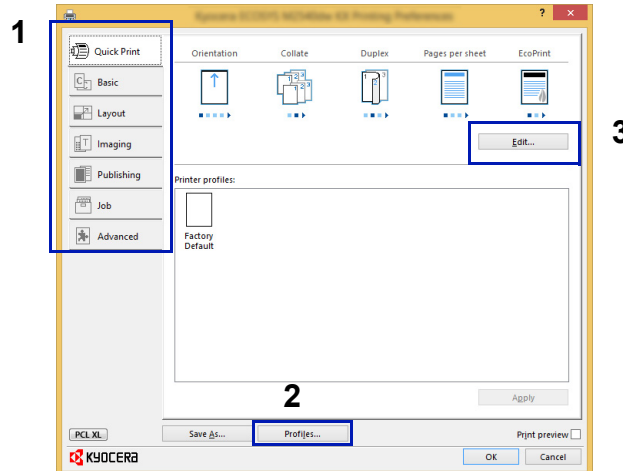

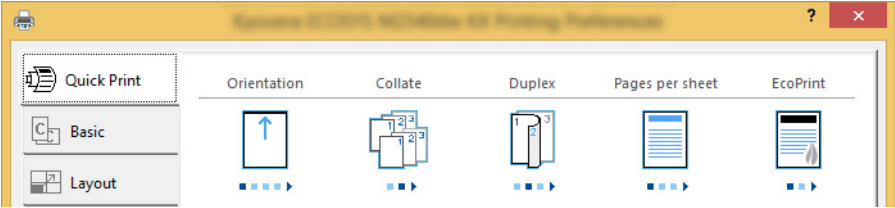
No.	Description
1	<p>Quick Print Provides icons that can be used to easily configure frequently used functions. Each time you click an icon, it changes to an image resembling the print results and applies the settings.</p>  <p>Basic This tab groups basic functions that are frequently used. You can use it to configure the paper size, media type, destination, and duplex.</p> <p>Layout This tab lets you configure settings for printing various layouts, including booklet printing, combine mode, poster printing, and scaling.</p> <p>Imaging This tab lets you configure settings related to the quality and grayscale adjustment of the print results.</p> <p>Publishing This tab lets you create covers and inserts for print jobs and put inserts between sheets of OHP film.</p> <p>Job This tab lets you configure settings for saving print data from the computer to the machine. Regularly used documents and other data can be saved to the machine for easy printing later. Since saved documents can be printed directly from the machine, this function is also convenient when you wish to print a document that you don't want others to see.</p> <p>Advanced This tab lets you configure settings for adding text pages or watermarks to print data.</p>
2	<p>Profiles Printer driver settings can be saved as a profile. Saved profiles can be recalled at any time, so it is a convenient practice to save frequently used settings.</p>
3	<p>Reset Click to revert settings to their initial values.</p>

Printing on Non-standard Sized Paper

When cardstock or an envelope is loaded in the Multi Purpose Tray, set the paper size and type and then register the paper size on the **Basic** tab of the print settings screen in the printer driver.

Once registered, the paper size can be selected from the **Page size** menu.

- 1 Display the print settings screen.
- 2 Click the **Basic** tab.
- 3 Click **Page Sizes...** to register the size.
- 4 Click **New**.
- 5 Enter the name of the paper.
- 6 Enter the paper size.
- 7 Click **Save**.
- 8 Click **OK**.
- 9 In the **Print size** menu, Select the page size (name) registered in steps 4 to 8.
- 10 Select **MP Tray** in the **Source** menu.
- 11 Select the type of paper in the **Media type** menu.

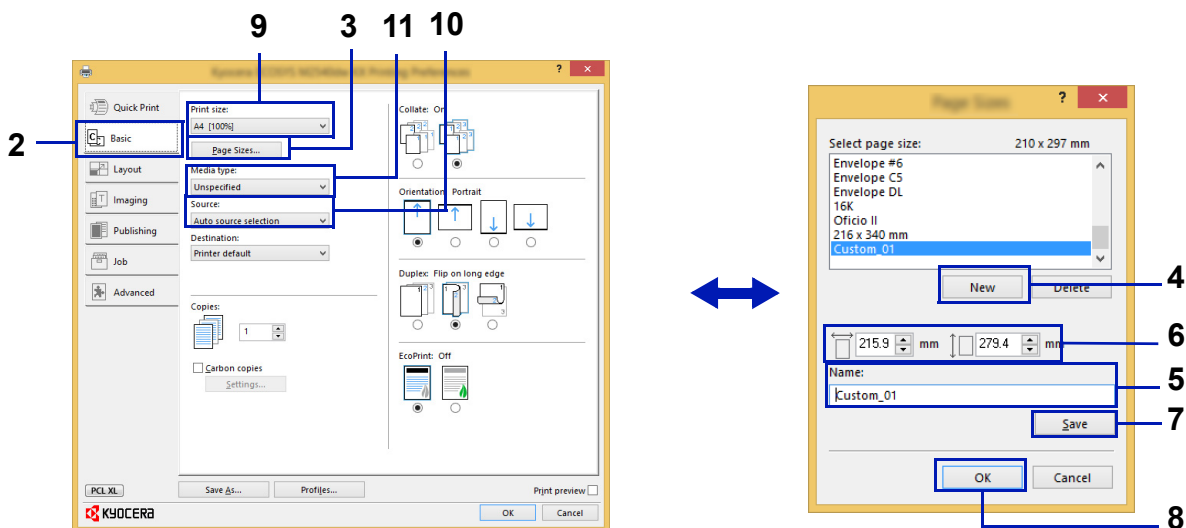

Banner Printing

When a document length from 470.5 mm (18.53") to a maximum of 915mm (36.03") is specified for printing, the print job is treated as banner printing.

Max. number of sheets	1 sheet (manual feed)
Paper width	210 mm to 216 mm (8.27" to 8.51")
Paper length	470.5 mm to 915 mm (18.53" to 36.03")
Paper weight	120 to 163 g/m ²
Media type	Heavy 2

- 1** Display the print settings screen.
- 2** Click the **Basic** tab.
- 3** Click **Page Sizes...** to register the size.
- 4** Click **New**.
- 5** Enter the name of the paper.
- 6** Enter the length (470.5 mm (18.53") or longer), and width of the custom paper size being registered.
- 7** Click **Save**.
- 8** Click **OK**.
- 9** In the **Print size** menu, Select the page size (name) registered in steps 4 to 8.
- 10** Select **MP Tray** in the **Source** menu.
- 11** Select the type of paper in the **Media type** menu.

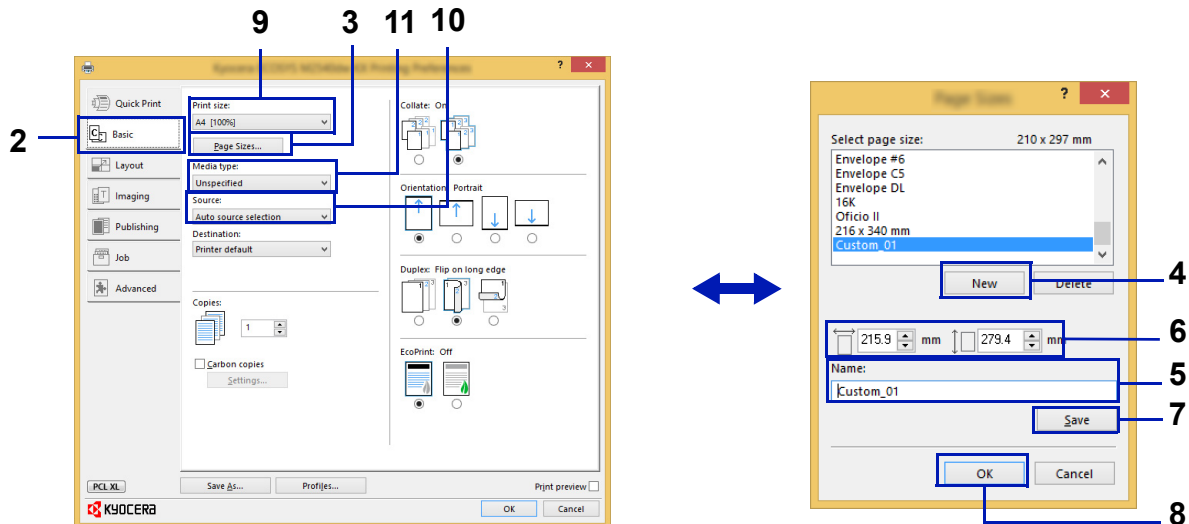

- 12** Click **OK**.



Note When KPD/L is used for "PDL" Settings of the printer driver, a length setting of 470.5 mm (18.53") or longer is handled as banner print.

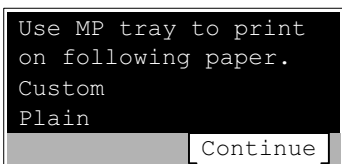

13 Click **OK**.

When you execute printing in this case, a message appears on the machine's operation panel. Place the paper in the Multi Purpose tray, continue to support it so that it does not fall, and press [Continue] ([Right Select]). To cancel printing, press [Cancel].

IMPORTANT After pressing [Continue] ([Right Select]), support the paper with both hands so that it feeds in correctly.

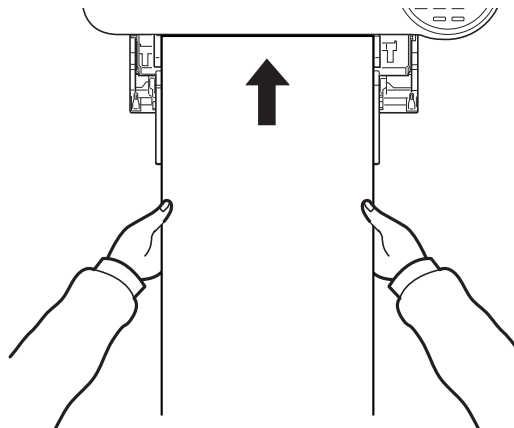

After printing starts, catch the paper when it is output so that it does not fall. When using the inner tray as the output location, do not stand up the stopper.

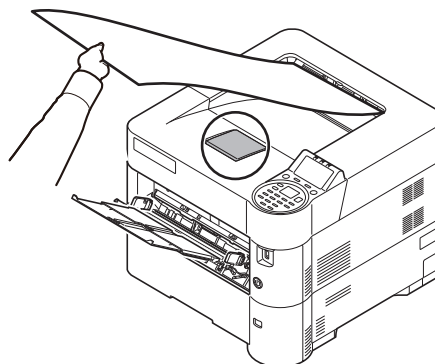

Set whether the confirmation screen appears before each sheet is printed when printing multiple banner sheets.

- Msg Banner Print (Check setting before banner printing)...4-120

Printer Driver Help

The printer driver includes Help. To learn more about print settings, display the printer driver print settings screen and display Help using either of the methods explained below.

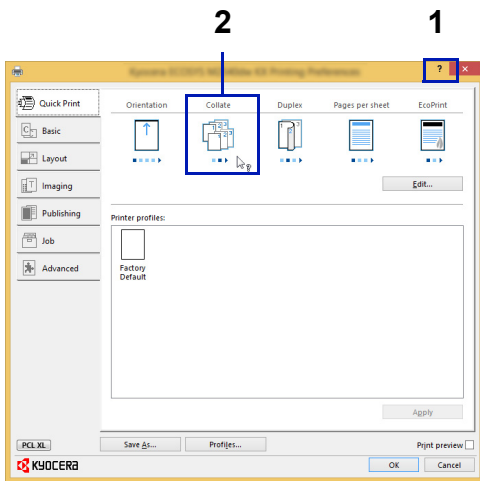

- Click the ? button in the upper right corner of the screen and then click the item you want to know about.
- Click the item you want to know about and press the [F1] key on your keyboard.

Changing the Default Printer Driver Settings (Windows 8.1)

The default printer driver settings can be changed. By selecting frequently used settings, you can omit steps when printing. For the settings, refer to *Printer Driver User Guide*.

- 1 In charms on Desktop, click **Settings, Control Panel**, and then **Devices and Printers**.
- 2 Right-click the printer driver icon of the machine, and click **Printer properties** menu of the printer driver.
- 3 Click **Preferences** on the **General** tab.
- 4 Select the default settings and click **OK**.

Printing Functions

This section explains the useful functions which can be set with the Printer Driver. For more information, refer to the *Printer Driver User Guide*.

Half Speed Mode (Printer Driver Settings)

Half speed mode reduces the print speed to half the rated speed. When selected, the toner adheres better when printing on small size, thick, or textured paper. In addition, you can select the half speed mode to feed thick paper smoothly and avoid the paper jam. This mode may result in quieter printing.



Note Half speed mode applies to all media types except Transparency and Vellum.

Line Thinning (Printer Driver Settings)

Line thinning reduces the pen width of lines used for barcodes and line drawings. Drawing values controlled by an application are not changed.

Item	Description
Off	Line thinning is not applied.
Barcodes	This setting reduces the pen width value for vertical and horizontal lines. It improves the readability of barcodes.
Fine lines	This setting reduces the pen width value for vertical, horizontal, and diagonal lines.
All	This setting reduces the pen width by a value of 1 for vertical, horizontal, and diagonal line used in barcodes or line drawings.



Note Line thinning is available when PCL XL is selected in the PDL Settings dialog box. When GDI compatible mode is selected in the PDL Settings dialog box, Line thinning is not available.

Correct Fine Line by Device

Enable correction of pen width by device. This feature is available only on supported models.

Custom Box (Optional Feature)

Custom Box is a component box which you can create within the Document Box and store data for later retrieval.

You can create or delete a Custom Box, and data can be exchanged in various ways. To use a Custom Box, an optional SSD must be installed in the printer.

For more details on Custom Box operation, refer to *Custom Box on page 5-3*.

Job Box (Optional Feature)

Job Box holds temporary or permanent print data for use with job options including Private Print, Stored Job, Quick Copy and Proof and Hold which will be discussed later.

Four individual Job Boxes corresponding to these job options are already provided in the Document Box. These Job Boxes cannot be created or deleted by a user.

For more details on Job Box operation, refer to *Job Box on page 5-21*.

ThinPrint Activation (Optional Feature)

This printer can select whether or not to communicate using ThinPrint.

For more details on operation, refer to *Op Functions (Optional application settings)* on page 4-154.

Secure Pull Printing (Optional Feature)

Secure Pull Printing is a printing feature where a user pulls the print job to a printer selected after the job is spooled in a server. To use this feature, the following system environments are required.

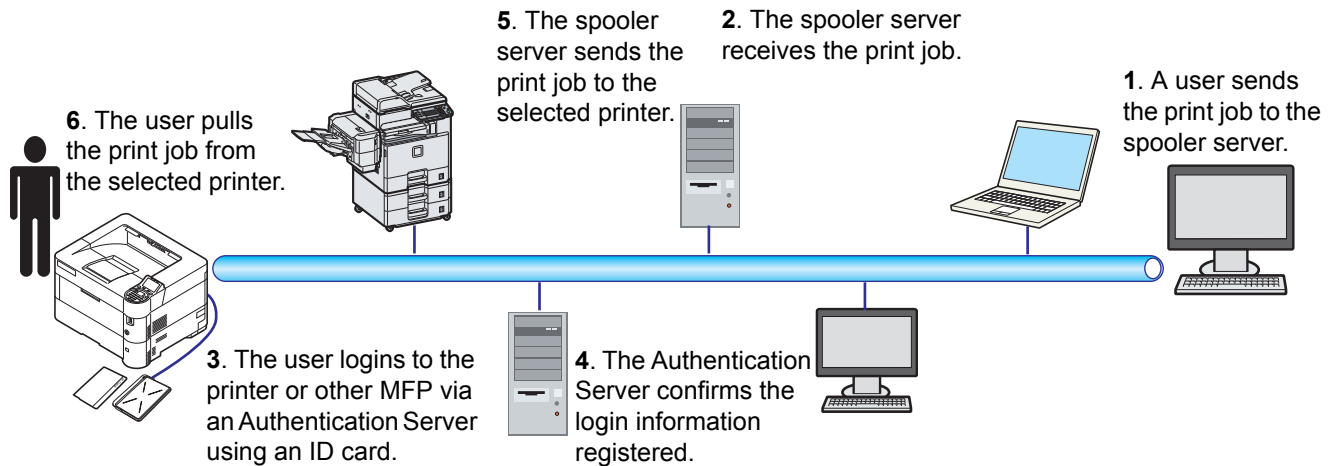

The Authentication server: KYOCERA Net Manager (Optional Software) must be installed.

ID card and ID card reader: they are used to register and authenticate a user.

The Spooler server: it sends the print job to a selected printer after the user logs in.

For more details, contact your dealer or service representative.

Printing by Google Cloud Print

Google Cloud Print is a printing service provided by Google and does not require a printer driver. This service enables a user with a Google account to print from a machine connected to the Internet.

The machine can be configured in the Command Center RX. Refer to the *Command Center RX User Guide*.



Note A Google account is necessary to use Google Cloud Print. Obtain a Google account if you do not have one.

It is also necessary to register the machine with the Google Cloud Print service in advance. The machine can be registered from a PC connected to the same network.

Printing with Wi-Fi Direct

Wi-Fi Direct is a wireless LAN standard that Wi-Fi Alliance has been established. This is one of the functions of the wireless LAN, without a wireless LAN access point or wireless LAN router, between devices can communicate directly on a peer to peer basis.

The printing procedure by the Wi-Fi Direct is the same as that from the normal handheld devices.

When you use a printer name or Bonjour name on the port settings of the printer property, you can print the job by specifying the name at Wi-Fi Direct connection.

When you use an IP address for the port, specify the IP address of this machine.

Printing by AirPrint

AirPrint is a printing function that is included standard in iOS 4.2 and later products, and Mac OS X 10.7 and later products.

To use the AirPrint, make sure that the AirPrint setting is enabled in the Command Center RX.

For details, refer to the Command Center RX User Guide.



Printing by Mopria

Mopria is a standard on printing function included in Android 4.4 or later products.

Mopria Print Service needs to be installed and enabled in advance.

For details on how to use, refer to a Web site of Mopria Alliance.

4 Operation Panel

This chapter contains explanations on the following topics:

Message Display	4-2
Keys	4-4
Using the Menu Selection System	4-7
Setting a Mode Selection Menu	4-9
Report	4-10
USB Memory (USB memory selection)	4-21
Counter (Viewing the counter value)	4-29
Paper Settings	4-30
Print Settings	4-44
Network (Network settings)	4-60
Optional Network (Optional Network settings)	4-82
Device Common (Selecting/Setting the common device)	4-93
Security (Security function setting)	4-121
User/Job Account (User Login Setting/Job Account setting)	4-129
Adjust/Maint. (Adjust/Maintenance selection/setting)	4-150
Op Functions (Optional application settings)	4-154

Message Display

Messages indicating the status of the various printer operations are displayed on the message display.

Status Information

Message	Meaning
Please wait.	The printer is warming up and is not ready. When the printer is switched on for the first time, this message will take several minutes.
Please wait. Loading paper.	The paper in the cassette is being moved to a position where paper feed is possible. This message is sometimes displayed for a short period when the cassette is returned to its original position, for example, after paper is added. Note This message is not displayed on ECOSYS P3045dn.
Please wait. Adding toner...	Toner is currently being replenished. This message may be displayed during continuous printing of a large volume of pages which require a large amount of toner such as with photographs, etc.
Ready to print.	The printer is ready to print.
Processing.	The printer is receiving data to print. This is also shown when the printer is reading an SD card, USB memory, SSD or RAM disk.
Sleeping...	The printer is in Sleep. The printer wakes from Sleep whenever a print job is received.
Canceling...	Jobs inside the printer are being canceled. To cancel a job, refer to <i>Canceling a Printing Job on page 4-4</i> .

Error Codes

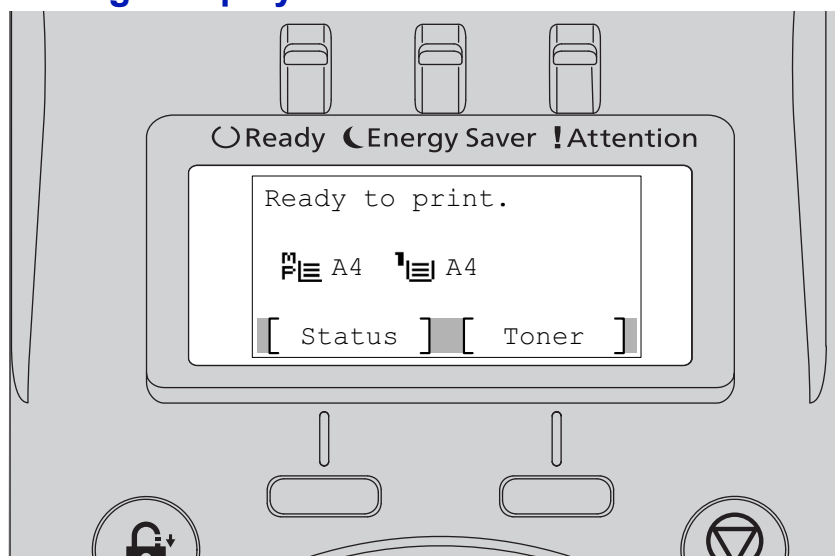

For information on error code and errors where the printer requires the operator's attention, refer to *Error Messages on page 8-6*.

Indicators in Message Display



Ready, Data, and Attention Indicators

The following indicators light during normal operation and whenever the printer needs attention. Depending on the status of lighting, each indicator has the following meaning:

Indicator	Description
 ○ Ready	<p>Flashing. Receiving data, processing data, accessing memory, or clearable error has occurred. For details, refer to <i>Troubleshooting on page 8-1</i>.</p> <p>On. Indicates that the printer is ready and on-line. The printer prints the data it receives.</p> <p>Off. Indicates that the printer is off-line because printing is manually stopped or automatically stopped due to an error condition. Data can be received but will not be printed. For details, refer to <i>Error Messages on page 8-6</i> if printing is automatically stopped when an error condition has occurred.</p>
 ☾ Energy Saver	<p>On. The printer is in Sleep. The printer wakes from Sleep whenever a print job is received. The printer then warms up and goes on-line. For details on Sleep, refer to <i>Sleep Timer (Sleep timer timeout time) on page 4-110</i>.</p>
 ! Attention	<p>Flashing. If <code>Please wait</code> is displayed, the printer is warming up. Or, the printer cannot print for some reason (e.g. there is no paper in the cassette). Check the message display and carry out the required action. For details, refer to <i>Error Messages on page 8-6</i>.</p> <p>On. The printer cannot print due to an error. Check the message display and carry out the required action. For details, refer to <i>Error Messages on page 8-6</i>.</p>

Keys

The operation panel keys are used to configure the printer operation. Note that certain keys have a secondary function.

Cancel Key



This key is used to:

- Cancel a printing job.
- Stop the alarm sound.

Canceling a Printing Job

- 1** While the printer displays `Processing.`, press **[Cancel]**.

The `Job Cancel List` appears, showing the list of current print jobs.

- 2** Press Δ or ∇ to display the desired job and then press **[OK]**.

When the `Job will be canceled. Are you sure?` message appears, press `[Yes]` (**[Left Select]**) to cancel the job or `[No]` (**[Right Select]**) to cancel this operation and continue printing.

When you cancel a job, `Canceling...` appears on the message display and printing stops after the page currently printing has been fed output.

Logout Key



- If user control is set then please log out by pressing **[Logout]** after operations are completed.

Menu Key

Menu



- **[Menu]** lets you enter the menu system to change the setup and printing environment of the printer.

Back Key

Back



- Cancels the menu setting currently displayed and returns to the menu for the previous step.

Arrow Keys

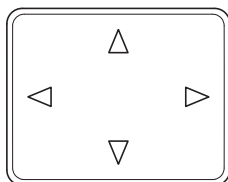

- The four arrow keys are used in the menu system to access an item or enter numeric values.

OK Key



- Finalize settings of numeric values and other selections.

Numeric Keys

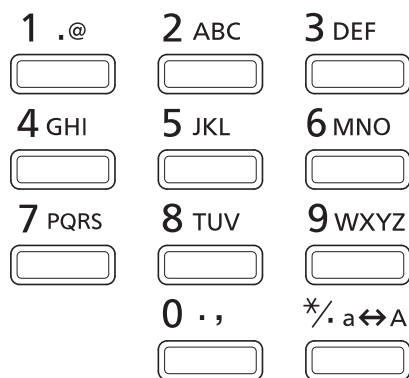

- Enter numbers and symbols.

Clear Key

C Clear

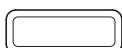

- Clears entered numbers and characters.

Document Box Key

 Document Box

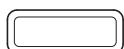

- Press this key when using Document Box. For details, refer to *Document Box on page 5-1*.

Left Select Key / Right Select Key



- These keys only function when the respective key tabs are shown in the message display. Pressing the key executes the function shown in the message display.

Pressing the key executes the function shown in the message display.

E.g.:

When the menu shown below is displayed, pressing **[Left Select]** ([Yes]) prints the file selected. Pressing **[Right Select]** ([No]) stops printing and returns to the menu for the previous step.

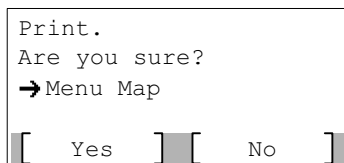

- These keys only function when the paper jam message has appeared on the message display. A help message will then appear to facilitate jam clearing in the location.

Using the Menu Selection System

Menu Selection System

This section explains how to use the menu selection system.

[Menu] on the operation panel allows you to use the menu to configure the printer settings to your specific needs. Settings can be made when Ready to print., Please wait., Processing. or Sleeping... is indicated on the printer message display.

 **Note** Settings that are received from application software and the printer driver will take priority over settings made in the operation panel.

Entering the Mode Selection Menu

Press **[Menu]** when Ready to print. is indicated on the printer message display.

The mode selection menu is displayed.

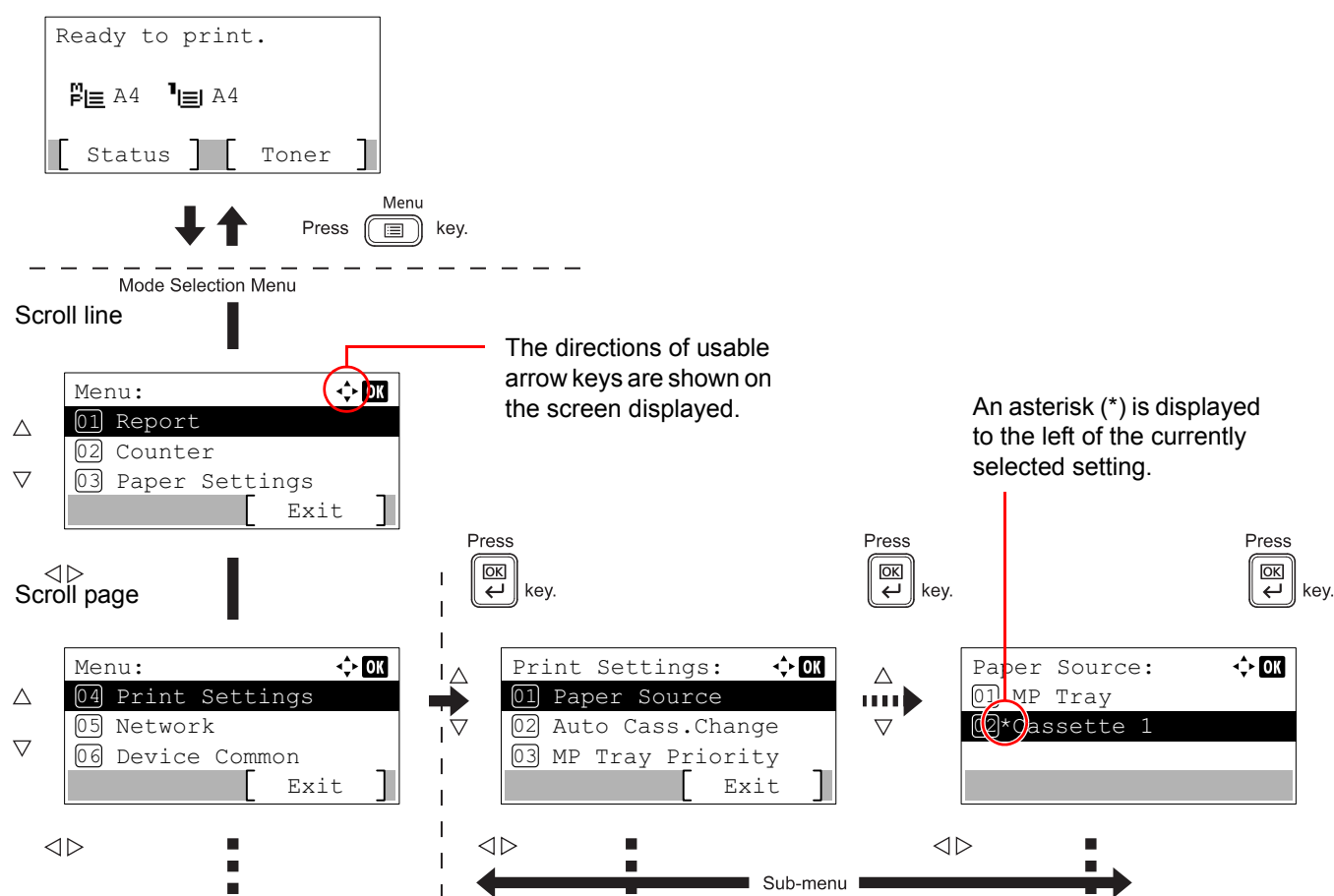

Selecting a Menu

The mode selection menu is hierarchical. Press Δ , ∇ , \triangleleft or \triangleright to display the desired menu.

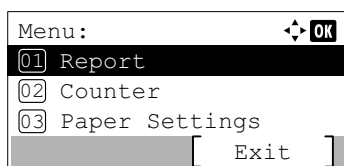

- If [\blacklozenge] appears in the top-right of the screen, you can use the Δ and ∇ to scroll up and down through the menu options one line at a time, and the \triangleleft and \triangleright to move between menu options one page at a time.

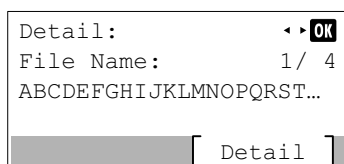

- If [\blacktriangleleft] appears in the top-right of the screen, you can use the \triangleleft and \triangleright to switch between pages.

To return to the menu one level up, press **[Back]**.

Setting a Menu

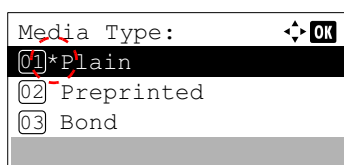

Select the desired menu and press **[OK]**. You can now select options in the menu. Press Δ , ∇ , \triangleleft or \triangleright to select or enter the desired setting and then press **[OK]** to confirm your selection.

If you are choosing from a list of settings, an asterisk (*) is displayed to the left of the currently selected setting.

Canceling Menu Selection

If you press **[Menu]** when a menu is selected, the message display returns to *Ready to print*.

Setting a Mode Selection Menu

This section explains the setting procedures used for each menu item in the mode selection menu.

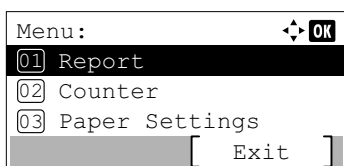

1 While the printer displays `Ready to print., Please wait., Processing. and Sleeping...`, press **[Menu]**. The mode selection menu is displayed.

2 Each time you press Δ or ∇ , the selection changes.

- Report...4-10
- USB Memory...4-21
- Counter...4-29
- Paper Settings...4-30
- Print Settings...4-44
- Network...4-60
- Optional Network...4-82
- Device Common...4-93
- Security...4-121
- User/Job Account...4-129
- Adjust/Maint. ...4-150
- Op Functions...4-154



Note `Optional Network` is only displayed when a `Network Interface Kit (IB-50)` or `Wireless Network Interface Kit (IB-51)` is installed as an option.

`USB Memory` is only displayed when USB memory is installed.

Report

These are the settings for printing reports and sending the Job Log History. The options available in the Report menu are as follows:

- Report Print...4-10
- Job Log History (Sending Job Log History)...4-16

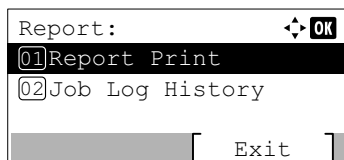

- 1 Press **[Menu]**.
- 2 Press Δ or ∇ to select Report.
- 3 Press **[OK]**. The Report menu appears.



Note When user login administration is enabled, Job Log History is displayed when logged in with administrator authority.

Report Print

Prints a report. The options available in the Report Print menu are as follows:

- Menu Map (Printing a menu map)...4-10
- Status Page (Printing a printer's status page)...4-12
- Font List (Printing a list of the printer's fonts)...4-14
- RAM File List (Printing a list of the files on the RAM disk)...4-15
- SSD File List (Printing a list of the files on the SSD)...4-15
- SD Card FileList (Printing a list of the files on an SD card)...4-15

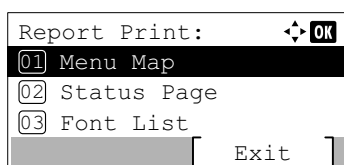

- 1 In the Report menu, press Δ or ∇ to select Report Print.
- 2 Press **[OK]**. The Report Print menu appears showing a list of the types of report that can be printed. Note that report types shown may vary depending on which optional units are installed in the printer.

Menu Map (Printing a menu map)

The printer prints a full list of the menu selection system menu map.

- 1 In the Report Print menu, press Δ or ∇ to select Menu Map.
- 2 Press **[OK]**. A confirmation message is displayed.



Note When Job Accounting is set but user login is not set, the screen for entering Job Accounting information is displayed. Enter the Account ID and press **[OK]**.

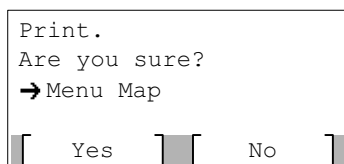

- 3 Press **[Yes]** (**[Left Select]**). The message Accepted. appears and the printer prints the menu map.
Pressing **[No]** (**[Right Select]**) returns to the Report Print menu without printing the menu map.



Note It is possible to use the numeric keys to enter the Menu number and display the settings required.

e.g.: Displaying the Menu Map printing menu

- 1 Press **[Menu]**.
- 2 Press **[1]** on the Numeric Keys. The `Report` menu appears.
- 3 Press **[1]** on the Numeric Keys. The `Report Print` menu appears.
- 4 Press **[1]** on the Numeric Keys. A confirmation message is displayed.

Menu Map Sample

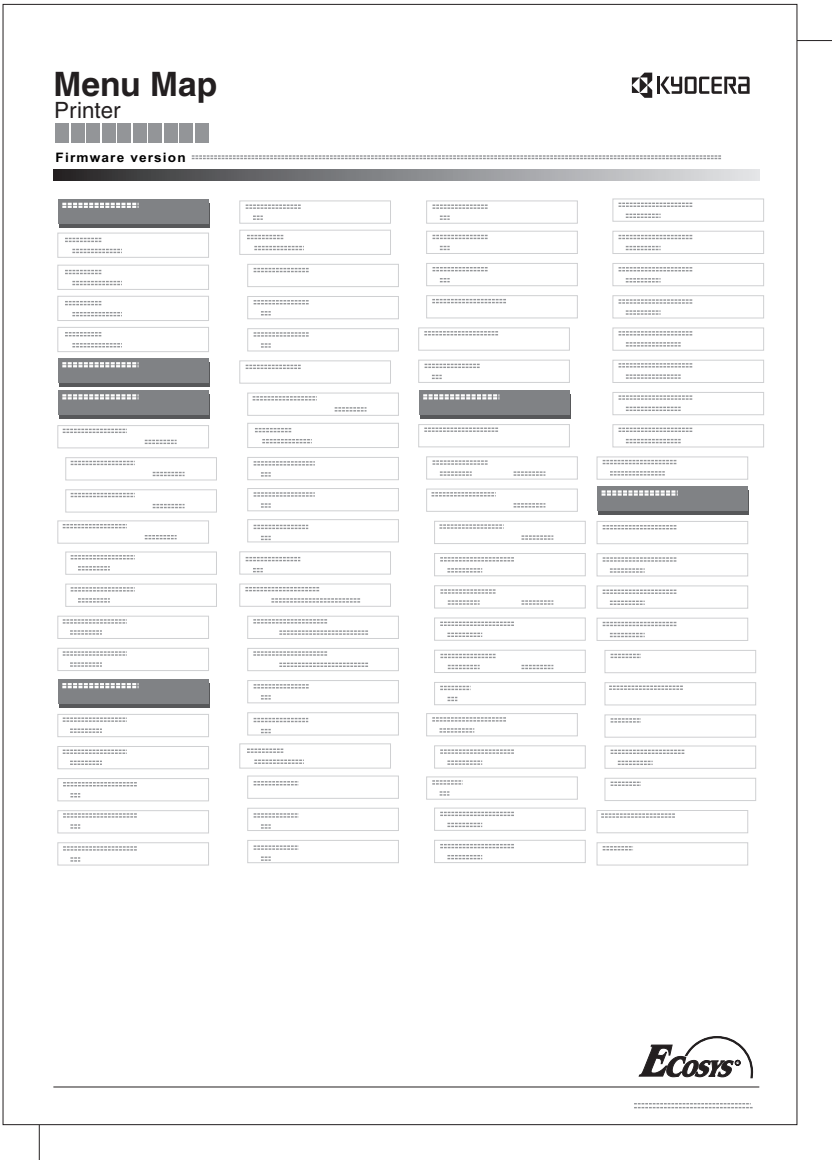

Status Page (Printing a printer's status page)

You can check the printer's current status and option settings by printing a status page.

- 1 In the `Report Print` menu, press Δ or ∇ to select `Status Page`.
- 2 Press **[OK]**. A confirmation message is displayed.



Note When Job Accounting is set but user login is not set, the screen for entering Job Accounting information is displayed. Enter the Account ID and press **[OK]**.

- 3 Press **[Yes]** (**[Left Select]**). The message `Accepted.` appears and the printer prints the status page.

Pressing **[No]** (**[Right Select]**) returns to the `Report Print` menu without printing the status page.

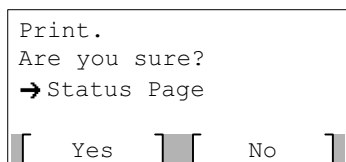

Understanding the Status Page

The numbers in the following diagram refer the items explained below the diagram. The items and values on the status page may vary depending on the printer's firmware version.

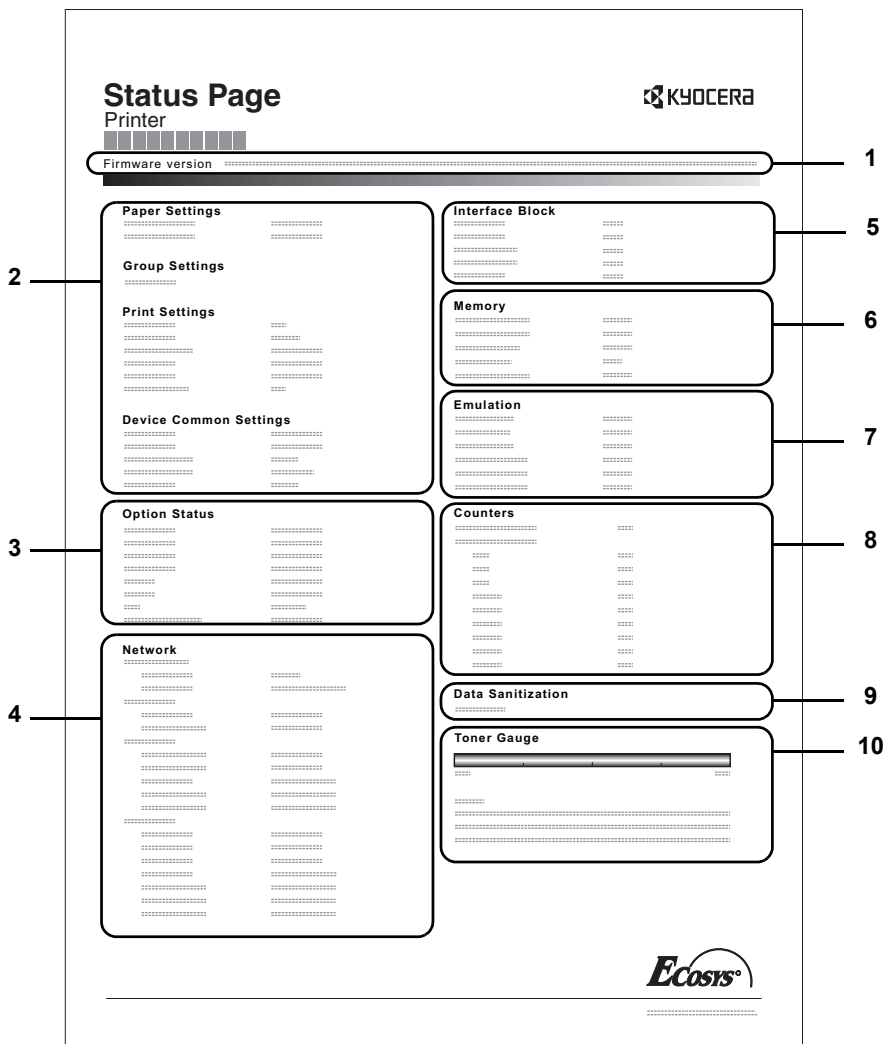

1 Firmware Version

This item shows the version and release date of the printer firmware.

2 Printer Settings Information

This item shows various printer settings for hardware-related items:

- MP tray paper size and type
- Paper cassette size and type
- Copies
- KIR mode
- Resolution
- Sleep level
- Sleep time
- Power off time
- Form feed timeout time
- MP tray empty

3 Installed Options

This item shows the options installed in the printer:

- Paper Feeder
- SD card
- SSD
- Card Authentication Kit(B)
- Data Security Kit(E)
- UG-33

4 Network Status

This item shows the IP address, subnet mask address, and default gateway address for the network interface card in the printer.

5 Interface Information

This information shows the block status for items including the USB memory slot and USB interface. When connected by network interface card (NIC), block status is shown for an optional interface.

6 Memory

This item shows:

- Standard memory in the printer
- Option memory slot status in megabytes
- Total memory in the printer
- Current status of the RAM disk

7 Emulation

This item shows all available emulations of the printer. The PCL 6 emulation is set as the default when the printer is shipped from the factory. The emulations are:

- PCL 6
- KPDL
- Line Printer
- IBM Proprinter
- EPSON LQ-850

8 Page Information

This shows counter information. Total printed page count and total page count of each paper size.

9 Data Sanitization

The status of the Data Sanitization implementation is displayed.

10 Consumable Status

This item shows the approximate level of remaining toner. When the value is 100, the toner container is full. The closer to 0, the smaller the amount of remaining toner.

Font List (Printing a list of the printer's fonts)

To help you decide in selecting a font, you can printout lists of the internal fonts or the optional fonts.

- 1 In the Report Print menu, press Δ or ∇ to select Font List.
- 2 Press [OK]. A confirmation message is displayed.



Note When Job Accounting is set but user login is not set, the screen for entering Job Accounting information is displayed. Enter the Account ID and press [OK].

- 3 Press [Yes] ([Left Select]). The message Accepted. appears and the printer prints the font list.

Pressing [No] ([Right Select]) returns to the Report Print menu without printing the font list.

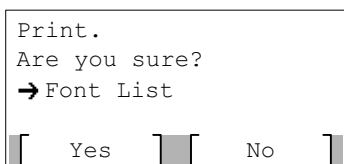

Font List Sample

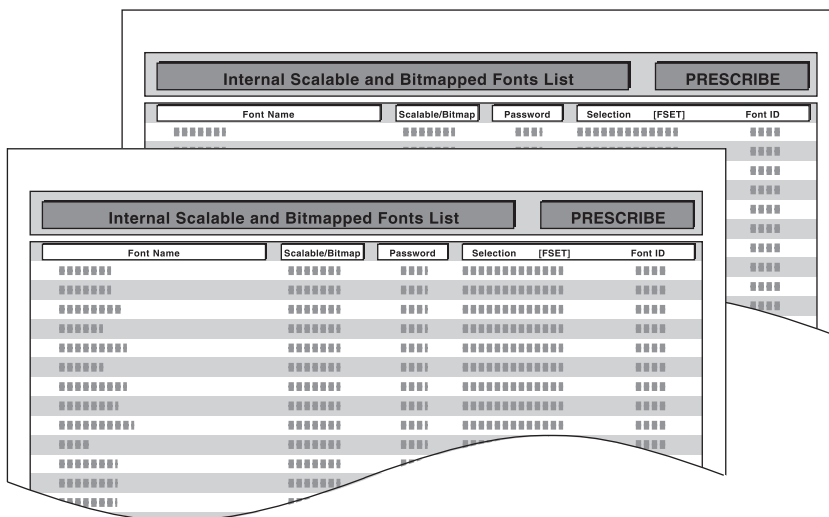

RAM File List (Printing a list of the files on the RAM disk)

This allows you to print a list of the files on the RAM disk.

IMPORTANT This is displayed when RAM Disk Mode is set to On.

1 In the `Report Print` menu, press Δ or ∇ to select `RAM File List`.

2 Press **[OK]**. A confirmation message is displayed.



Note When Job Accounting is set but user login is not set, the screen for entering Job Accounting information is displayed. Enter the Account ID and press **[OK]**.

3 Press `[Yes]` (**[Left Select]**). The message `Accepted.` appears and the printer prints a list of the files held in the RAM disk.

Pressing `[No]` (**[Right Select]**) returns to the `Report Print` menu without printing the RAM disk file list.

```
Print.
Are you sure?
→RAM File List
[ Yes ] [ No ]
```

SSD File List (Printing a list of the files on the SSD)

This allows you to print a list of the files on the SSD.

IMPORTANT This is only displayed when the printer has an optional SSD installed and the drive is correctly formatted.

1 In the `Report Print` menu, press Δ or ∇ to select `SSD File List`.

2 Press **[OK]**. A confirmation message is displayed.



Note When Job Accounting is set but user login is not set, the screen for entering Job Accounting information is displayed. Enter the Account ID and press **[OK]**.

3 Press `[Yes]` (**[Left Select]**). The message `Accepted.` appears and the printer prints a list of the files held on the SSD.

Pressing `[No]` (**[Right Select]**) returns to the `Report Print` menu without printing the SSD file list.

```
Print.
Are you sure?
→SSD File List
[ Yes ] [ No ]
```

SD Card FileList (Printing a list of the files on an SD card)

This allows you to print a list of the files on an SD card.

IMPORTANT This message will be displayed only when the SD card is installed in the printer and properly formatted.

1 In the `Report Print` menu, press Δ or ∇ to select `SD Card FileList`.

2 Press **[OK]**. A confirmation message is displayed.



Note When Job Accounting is set but user login is not set, the screen for entering Job Accounting information is displayed. Enter the Account ID and press **[OK]**.

3 Press `[Yes]` (**[Left Select]**). `Accepted.` appears and the printer prints a list of the files held on the SD card.

Pressing `[No]` (**[Right Select]**) returns to the `Report Print` menu without printing the SD card file list.

```
Print.
Are you sure?
→SD Card FileList
[ Yes ] [ No ]
```

Job Log History (Sending Job Log History)

This sets the sending of the Job Log History.

 **Note** When user login administration is enabled, Job Log History is displayed when logged in with administrator authority.

To send E-mail from this machine, set the SMTP setting to On. For details, refer to the *Protocol/Settings (Detailed settings for the network protocol)* on page 4-78.

It is necessary to register a mail server. For the method for setting the server, refer to the section on *Command Center RX* on page 2-28.

The options available in the Job Log History menu are as follows:

- Auto Sending (Automatic Sending of Job Log History)...4-16
- Send History (Sending job log history)...4-17
- Destination (Setting the destination)...4-18
- Subject (Setting job log subject)...4-19
- Personal Info. (Personal information setting)...4-20



- 1 In the Report menu, press Δ or ∇ to select Job Log History.
- 2 Press [OK]. The Job Log History menu appears.

 **Note** If something other than Show All is set at Disp. Status/Log (Display Status/Log setting) (page 4-117), then the log in screen appears. Enter the login user name and password, and press [Login] ([Right Select]).

Auto Sending (Automatic Sending of Job Log History)

This function automatically sends the job log history to the specified destination whenever a set number of jobs has been logged. Set the destinations in advance by referring to *Destination (Setting the destination)* on page 4-18.

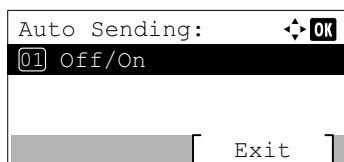

- 1 In the Job Log History menu, press Δ or ∇ to select Auto Sending.
- 2 Press [OK]. The Auto Sending menu appears.

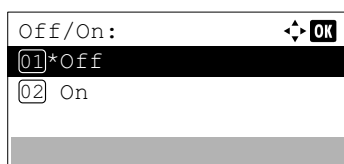

- 3 Press Δ or ∇ to select Off/On.
- 4 Press [OK]. The Off/On screen appears.



- 5 Press Δ or ∇ to select On or Off.
- 6 Press [OK]. The Auto Sending is set and the Job Log History menu reappears.
If On is selected, continue on and select the settings.

- 7 Press Δ or ∇ to select Auto Sending.

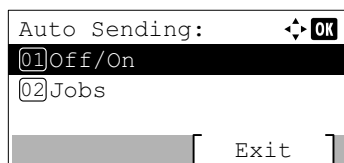

- 8** Press **[OK]**. The Auto Sending menu appears.

When Auto Sending is set to On in step 5, the setting for Jobs is displayed.

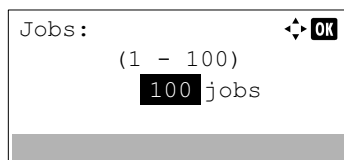

- 9** Press Δ or ∇ to select Jobs.

- 10** Press **[OK]**. The Jobs screen appears.

- 11** Use the numeric keys or press Δ or ∇ to specify the number of job log histories.

- 12** Press **[OK]**. The setting is stored and the Job Log History menu reappears.

Send History (Sending job log history)

You can also send the job log history to the specified destination manually. Set the destinations in advance by referring to *Destination (Setting the destination)* on page 4-18.

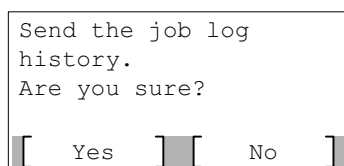

- 1** In the Job Log History menu, press Δ or ∇ to select Send History.

- 2** Press **[OK]**. A confirmation message is displayed.

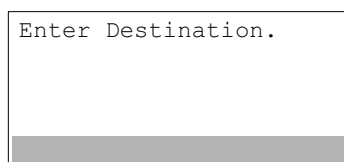

This message appears if no destination has been set.

- 3** Press **[Yes] ([Left Select])**. The message Accepted. appears and the printer sends the job log history.

Pressing **[No] ([Right Select])** returns to the Job Log History menu without sending the job log history.

Destination (Setting the destination)

Set the destination to which log histories are sent. Only E-mail address can be set.

The options available in the Destination menu are as follows:

- Address Entry (Entering an e-mail address)...4-18
- Confirmation (Checking and editing the destination)...4-18

- 1 In the Job Log History menu, press Δ or ∇ to select Destination.
- 2 Press [OK]. The Destination menu appears.

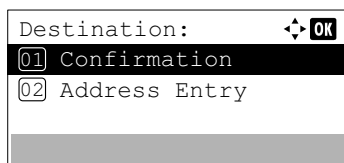

Address Entry (Entering an e-mail address)

Enter the destination to which log histories are sent.

- 1 In the Destination menu, press Δ or ∇ to select Address Entry.
- 2 Press [OK]. The Address Entry screen appears.

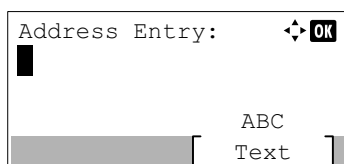

- 3 Enter the address using the numeric keys.



Note Up to 128 characters can be entered. For details on entering characters, refer to *Character Entry Method on page A-2*.

- 4 Press [OK]. Register the destination and the Job Log History menu reappears.

If the destination has already been registered, the message *Dest. is already registered. Do you want to overwrite?* appears.

Press [Yes] ([Left Select]) to overwrite the destination. Pressing [No] ([Right Select]) returns to the Destination menu without overwriting the destination.

Confirmation (Checking and editing the destination)

Check and edit the registered destination.

- 1 In the Destination menu, press Δ or ∇ to select Confirmation.
- 2 Press [OK]. The Dest. Confirm. screen appears. Check the destination.





3 To edit the destination, press **[OK]**.

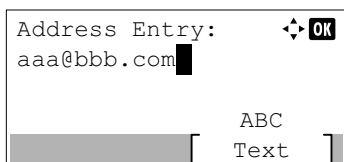

4 Press Δ or ∇ to select **Edit**.

5 Press **[OK]**.

6 Enter the address using the numeric keys.

 **Note** Up to 128 characters can be entered. For details on entering characters, refer to *Character Entry Method on page A-2*.

7 Press **[OK]**.



8 To delete the destination, press **[OK]**.



9 Press Δ or ∇ to select **Delete**.

10 Press **[OK]**. A confirmation message is displayed.

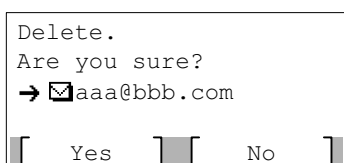

11 To proceed with deleting the destination, press **[Yes] ([Left Select])**. **Completed.** appears and the account is deleted.

Pressing **[No] ([Right Select])** returns to the **Dest. Confirm.** menu without deleting the destination.

Subject (Setting job log subject)

Set the subject automatically entered when sending log histories by E-mail.

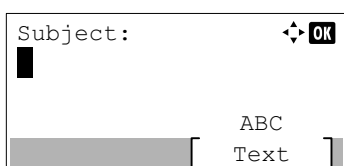

1 In the **Job Log History** menu, press Δ or ∇ to select **Subject**.

2 Press **[OK]**. The **Subject** screen appears.

- 3 Enter the subject using the numeric keys.



Note Up to 60 characters can be entered. For details on entering characters, refer to *Character Entry Method on page A-2*.

- 4 Press **[OK]**. The subject is set and the Job Log History menu reappears.

Personal Info. (Personal information setting)

Select whether to include personal information in the job log.

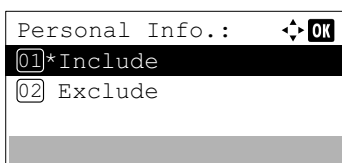

- 1 In the Job Log History menu, press Δ or ∇ to select Personal Info..
- 2 Press **[OK]**. The Personal Info. screen appears.
- 3 Press Δ or ∇ to select Include or Exclude.
- 4 Press **[OK]**. The setting is stored and the Job Log History menu reappears.

USB Memory (USB memory selection)

This specifies the settings for removing the USB memory and printing USB memory content.

The **USB Memory** menu automatically appears when you install the USB memory.

IMPORTANT This message is only displayed when the USB host block and USB Storage block are set to **Unblock**. For more information, please refer to *I/F Block Set. (External interface block setting)* on page 4-123.

The options available in the USB Memory menu are as follows:

- Print File (Printing and checking the files in the USB memory)...4-21
 - Display of File List...4-21
 - Print File (Printing the selected file)...4-22
- Print Function Settings...4-23
 - Quiet Mode (Selecting the Quiet Mode)...4-23
 - Duplex (Setting the duplex printing)...4-23
 - EcoPrint (Selecting the EcoPrint mode)...4-24
 - File Name Entry (Entering a file name)...4-24
 - JobFinish Notice (Setting for notification when jobs are finished.)...4-25
 - Encrypted PDF (Entering the PDF password)...4-26
 - TIFF/JPEG Size (Adjusting the TIFF/JPEG file print out size)...4-26
 - XPS FitTo Page (Adjusting the XPS file print out size)...4-27
- Detail (Shows the details of the selected file)...4-27
- Remove Memory (Removing the USB memory)...4-28

- 1** Press **[Menu]**.
- 2** Press Δ or ∇ to select **USB Memory**.
- 3** Press **[OK]**. The **USB Memory** menu appears showing a list of available actions.

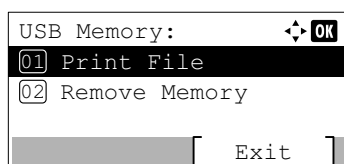

Print File (Printing and checking the files in the USB memory)

This displays a list of the files and folders in the USB memory. You can print the select file. You can also view the details of the selected file or folder.

The options available in the Print File menu are as follows:

- Display of File List...4-21
- Print File (Printing the selected file)...4-22

Display of File List

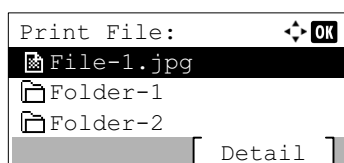

- 1** In the **USB Memory** menu, press Δ or ∇ to select **Print File**.
- 2** Press **[OK]**. File List appears showing a list of the files and folders in the USB memory.

If there are 4 or more files and folders, pressing Δ or ∇ repeatedly scrolls up or down through the list.

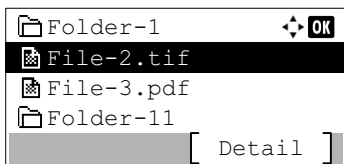

Press Δ or ∇ to select a folder and then press **[OK]**.
The folders and files in the selected folder are displayed.

IMPORTANT Print File only shows the PDF, TIFF, JPEG, XPS and OpenXPS files in the USB memory. Up to 3 folder levels can be displayed. Depending on the USB memory capacity and the number of files, the list may take some time to appear.

Print File (Printing the selected file)

You can use this to specify printing for files in the USB memory.

- 1 Use the procedure described in *Print File (Printing and checking the files in the USB memory)* on page 4-21 to display a list of the files in the folder containing the file you want to print.
- 2 Press Δ or ∇ to select the file you want to print.
- 3 Press **[OK]**. The **Copies** menu screen appears.
 -  **Note** When Job Accounting is set but user login is not set, the screen for entering Job Accounting information is displayed. Enter the Account ID and press **[OK]**.
- 4 To print 2 or more copies, Use the numeric keys or press Δ or ∇ to set the number of copies to be printed.

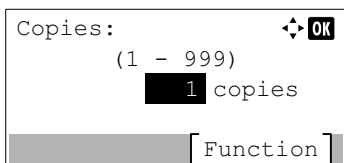

- 5 Press **[OK]**. The **Paper Source** menu screen appears.

 **Note** **[Function] ([Right Select])** can be pressed to change the print settings. For details, refer to *Print Function Settings* on page 4-23.

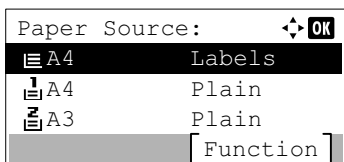

- 6 Press Δ or ∇ to select the tray containing the paper you want to use.
- 7 Press **[OK]**. The message **Accepted.** appears and printing begins.



Print Function Settings

When printing, the print settings can be changed.

Options available in Print Function Settings are as follows:

- Quiet Mode (Selecting the Quiet Mode)...4-23
- Duplex (Setting the duplex printing)...4-23
- EcoPrint (Selecting the EcoPrint mode)...4-24
- File Name Entry (Entering a file name)...4-24
- JobFinish Notice (Setting for notification when jobs are finished.)...4-25
- Encrypted PDF (Entering the PDF password)...4-26
- TIFF/JPEG Size (Adjusting the TIFF/JPEG file print out size)...4-26
- XPS FitTo Page (Adjusting the XPS file print out size)...4-27

Quiet Mode (Selecting the Quiet Mode)

Lower print speed for quiet processing. Select this mode when the running noise is uncomfortable. For details, refer to *Quiet Mode (Setting the Quiet Mode) on page 4-150*.



Note The processing speed will be slower than normal when in Quiet Mode.

This cannot be used when `Prohibit` is set for *Each Job (Permission for settings for each jobs) on page 4-151*.

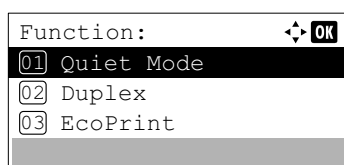

1 In the `Copies` menu or the `Paper Source` menu, press [Function] (**[Right Select]**). The `Function` menu appears.

2 Press Δ or ∇ to select `Quiet Mode`.

3 Press **[OK]**. The `Quiet Mode` screen appears.

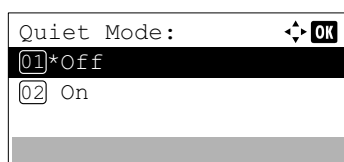

4 Press Δ or ∇ to select `On` or `Off`.

5 Press **[OK]**. The `Quiet Mode` is set and the `Function` menu reappears.

Duplex (Setting the duplex printing)

Set duplex printing. For details, refer to *Duplex (Setting the duplex printing) on page 4-46*.

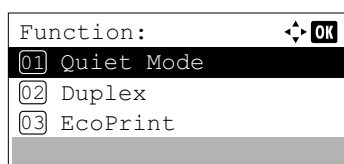

1 In the `Copies` menu or the `Paper Source` menu, press [Function] (**[Right Select]**). The `Function` menu appears.

2 Press Δ or ∇ to select `Duplex`.

3 Press **[OK]**. The `Duplex` screen appears showing the list of available duplex printing modes.

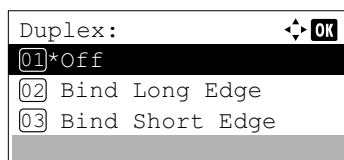

- 4 Press Δ or ∇ to select the desired duplex printing mode.

The message display toggles through the following:

Off

Bind Long Edge

Bind Short Edge

Selecting *Off* disables duplex printing.

- 5 Press **[OK]**. The duplex printing mode is set and the *Function* menu reappears.

EcoPrint (Selecting the EcoPrint mode)

Set EcoPrint mode. For details, refer to *EcoPrint (Selecting the EcoPrint mode)* on page 4-53.

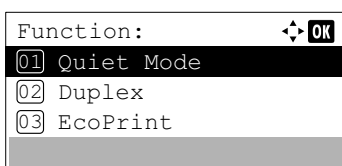

- 1 In the *Copies* menu or the *Paper Source* menu, press **[Function]** (**[Right Select]**). The *Function* menu appears.

- 2 Press Δ or ∇ to select *EcoPrint*.

- 3 Press **[OK]**. The *EcoPrint* screen appears.

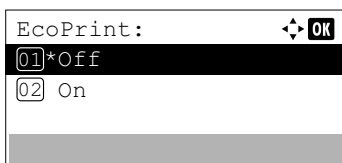

- 4 Press Δ or ∇ to select the *EcoPrint* mode.

- 5 Press **[OK]**. The *EcoPrint* mode is set and the *Function* menu reappears.

File Name Entry (Entering a file name)

Enter the file name. The file name entered is displayed as the Job Name in the Job Status and Job Log.

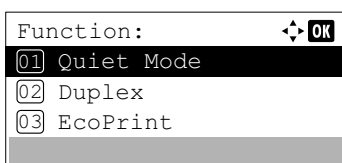

- 1 In the *Copies* menu or the *Paper Source* menu, press **[Function]** (**[Right Select]**). The *Function* menu appears.

- 2 Press Δ or ∇ to select *File Name Entry*.

- 3 Press **[OK]**. The *File Name Entry* screen appears.

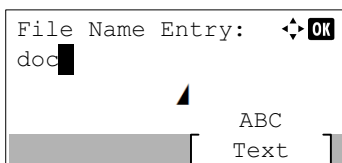

- 4 Enter the file name using the numeric keys.



Note Up to 32 characters can be entered. For details on entering characters, refer to *Character Entry Method* on page A-2.

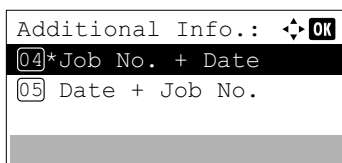

5 Press **[OK]**. The `Additional Info.` screen appears.

6 Press Δ or ∇ to select from the additional information that can be set for the file name.

The following settings can be selected.

- None (No additional information is added.)
- Date (To add the date.)
- Job No. (To add the Job Number.)
- Job No. + Date (To add the Job Number and date.)
- Date + Job No. (To add the date and Job Number.)

7 Press **[OK]**. Register the file name and the `Function` menu reappears.

JobFinish Notice (Setting for notification when jobs are finished.)

Notification that a job has finished is sent by E-Mail.

 **Note** To send E-mail from this machine, set the SMTP setting to `On`. For details, refer to the *ProtocolSettings (Detailed settings for the network protocol)* on page 4-78.

It is necessary to register a mail server. For the method for setting the server, refer to the section on *Command Center RX* on page 2-28.

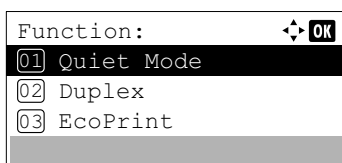

1 In the `Copies` menu or the `Paper Source` menu, press `[Function]` (**[Right Select]**). The `Function` menu appears.

2 Press Δ or ∇ to select `JobFinish Notice`.

3 Press **[OK]**. The `JobFinish Notice` screen appears.

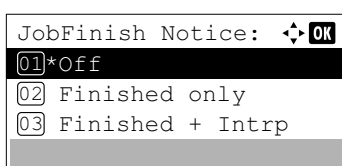

4 Press Δ or ∇ to select the condition for notification.

The following settings can be selected.

- Off (no notification)
- Finished only (notification only when job finishes)
- Finished + Intrp
(Notification when job finishes or is interrupted)

5 Press **[OK]**. The `Address Entry` screen appears.

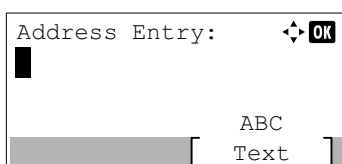

- Enter the address to be notified.



Note Up to 128 characters can be entered. For details on entering characters, refer to *Character Entry Method* on page A-2.

When user login administration is enabled, the address of the administrator or machine administrator is entered.

- Press **[OK]**. Register the address and the **Function** menu reappears.

Encrypted PDF (Entering the PDF password)

The password of a PDF file can be entered.

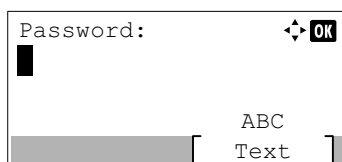
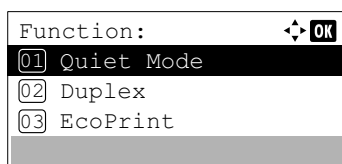

- In the **Copies** menu or the **Paper Source** menu, press **[Function]** (**[Right Select]**). The **Function** menu appears.

- Press Δ or ∇ to select **Encrypted PDF**.

- Press **[OK]**. The **Password** entry screen appears.

- Enter the password for the PDF file.



Note Up to 256 characters can be entered. For details on entering characters, refer to *Character Entry Method* on page A-2.

- Press **[OK]** to enter the password and the **Function** menu reappears.

TIFF/JPEG Size (Adjusting the TIFF/JPEG file print out size)

Use this setting to select the printing method used when TIFF or JPEG files are printed directly.

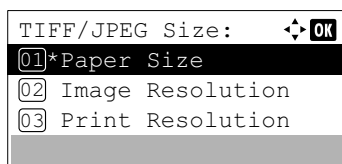
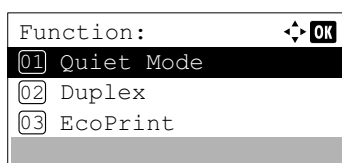

- In the **Copies** menu or the **Paper Source** menu, press **[Function]** (**[Right Select]**). The **Function** menu appears.

- Press Δ or ∇ to select **TIFF/JPEG Size**.

- Press **[OK]**. The **TIFF/JPEG Size** screen appears.

The options available in **TIFF/JPEG Size** are as follows:

- Paper Size**
Images are resized so that they fill the paper size when printed.
- Image Resolution**
Image files are printed at the resolution specified in the resolution information. Images with no resolution information are printed using the **Paper Size** setting.

- Print Resolution

Images are printed using a 1-to-1 correspondence between the image file pixels and printed dots. For example, the printed size of a 600 × 300-pixel image file is 1 inch × 1/2 inch.

- 4 Press Δ or ∇ to select whether TIFF/JPEG Size mode is enabled.
- 5 Press **[OK]**. The TIFF/JPEG Size setting is set and the **Function** menu reappears.



Note Images are automatically rotated during printing to provide a closer match between the aspect ratios of the image file and the paper used for printing.

XPS FitTo Page (Adjusting the XPS file print out size)

Select **On** in this setting to enlarge or reduce XPS files to fit the printable area during printing.

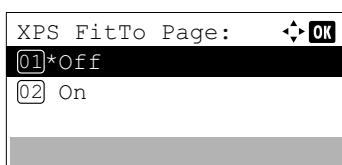
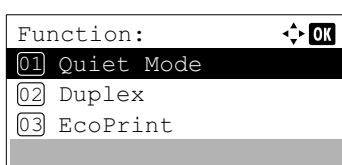

- 1 In the **Copies** menu or the **Paper Source** menu, press **[Function]** (**[Right Select]**). The **Function** menu appears.

- 2 Press Δ or ∇ to select **XPS FitTo Page**.

- 3 Press **[OK]**. The **XPS FitTo Page** screen appears.

- 4 Press Δ or ∇ to select whether **XPS FitTo Page** mode is enabled.

- 5 Press **[OK]**. The **XPS FitTo Page** setting is set and the **Function** menu reappears.

Detail (Shows the details of the selected file)

Use this to view detailed information on the files and folders in the USB memory.

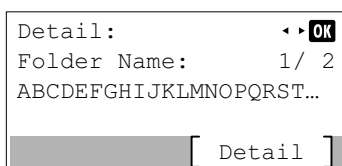
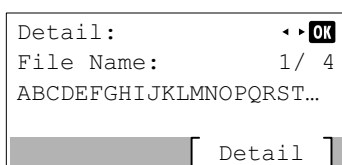

- 1 Use the procedure described in *Print File (Printing and checking the files in the USB memory)* on page 4-21 to display a list of the files or folders you want to check.

- 2 Press Δ or ∇ to select the folder or file you want to check.

- 3 Press **[Detail]** (**[Right Select]**). The **Detail** screen appears.

If you selected a file, there are 4 **Detail** screens. Press \triangleleft or \triangleright to move between the screens.

If you selected a folder, there are 2 **Detail** screens. Press \triangleleft or \triangleright to move between the screens.

Pressing **[OK]** while file or folder details are displayed returns you to the **Print File** menu.

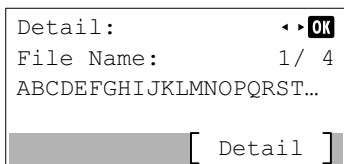

If the entire name shown as the File Name or Folder Name will not fit on one line, pressing [Detail] (**[Right Select]**) changes to a 3-line name display. If the name is 3 or more lines long, you can scroll up or down by pressing Δ or ∇ .

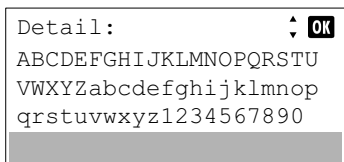

Pressing **[OK]** twice while file or folder details are displayed returns you to the Print File menu.

Remove Memory (Removing the USB memory)

Allows you to remove a USB memory device.

- 1 In the USB Memory menu, press Δ or ∇ to select Remove Memory.
- 2 Press **[OK]**. The printer is now ready for the USB memory to be removed and the message display returns to Ready to print.

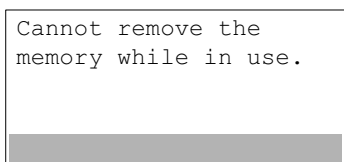

IMPORTANT If the screen on the left appears, the USB memory is still being used. Wait until the relevant job (e.g. printing from the USB memory) has ended and then repeat the Remove Memory procedure.

Counter (Viewing the counter value)

This only displays the total number of pages printed. You cannot change the displayed number.

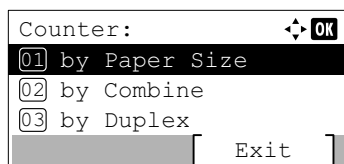

- 1** Press **[Menu]**.
- 2** Press Δ or ∇ to select Counter.
- 3** Press **[OK]**. The Counter menu screen appears.
- 4** Press Δ or ∇ to select by Paper Size, by Duplex, or by Combine.
- 5** Press **[OK]**. The number of printed pages for the function selected is displayed.

Paper Settings

This sets the paper size and type for the MP tray and cassettes from which paper is supplied.

The options available in Paper Settings are as follows:

- MP Tray Set. (MP tray settings)...4-30
- Cassette (1 to 5) Set. (Settings for the cassettes)...4-32
- Bulk Feeder Set. (Settings for the optional bulk paper feeder)...4-37
- Media Type Set. (Paper type settings)...4-39
- Reset Type Adj. (Resets customized settings)...4-42
- Paper Setup Msg(Check setting when loading paper)...4-43

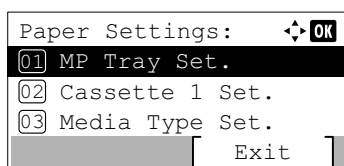

- 1 Press **[Menu]**.
- 2 Press Δ or ∇ to select Paper Settings.
- 3 Press **[OK]**. The Paper Settings menu appears showing a list of available options.

MP Tray Set. (MP tray settings)

To print correctly on paper supplied from the MP tray, use the procedure below to set the paper size and media type.

 **Note** Feeding the paper having a paper size which does not match the current paper size from the MP tray can cause paper jam.

The options available in MP Tray Set. menu are as follows:

- Paper Size (Paper size setting for the MP tray)...4-30
- Media Type (Paper type setting for the MP tray)...4-31

Paper Size (Paper size setting for the MP tray)

You can use this to set the paper size that can be supplied from the MP tray.

For more information about the paper sizes that you can feed from the MP tray, refer to *Minimum and Maximum Paper Sizes* on page A-12.

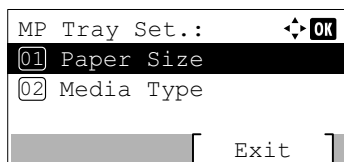

- 1 In the Paper Settings menu, press Δ or ∇ to select MP Tray Set..
- 2 Press **[OK]**. The MP Tray Set. menu screen appears.
- 3 Press Δ or ∇ to select Paper Size.

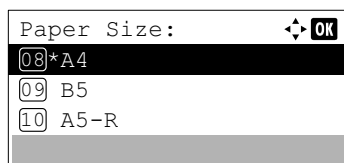

- 4 Press **[OK]**. The Paper Size screen appears listing the paper sizes that can be supplied from the MP tray.

The available paper sizes are as follows:

Envelope Monarch
 Envelope #10
 Envelope DL
 Envelope C5
 Executive
 Letter
 Legal
 A4
 B5
 A5-R
 A5
 A6
 B6
 Envelope #9
 Envelope #6
 ISO B5
 Custom
 Hagaki
 Oufukuhagaki
 Oficio II
 216x340mm
 16K
 Statement
 Folio
 Youkei 2
 Youkei 4

- 5 Press Δ or ∇ to select the desired paper size.
- 6 Press **[OK]**. The paper size for the MP tray is set and the MP Tray Set. menu screen reappears.

Media Type (Paper type setting for the MP tray)

You can use this to set the paper type that can be supplied from the MP tray.

For more information about paper types that you can feed from the MP tray, refer to *Paper* on page A-11.

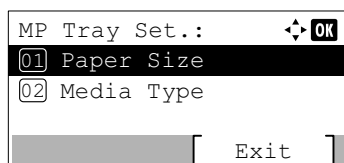

- 1 In the Paper Settings menu, press Δ or ∇ to select MP Tray Set..
- 2 Press **[OK]**. The MP Tray Set. menu screen appears.
- 3 Press Δ or ∇ to select Media Type.

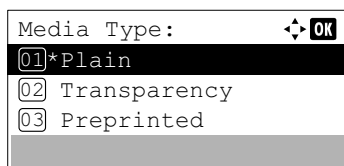

- 4** Press **[OK]**. The **Media Type** screen appears listing the media types that can be supplied from the MP tray.

The available media types are as follows:

Plain
 Transparency
 Preprinted
 Labels
 Bond
 Recycled
 Vellum
 Rough
 Letterhead
 Color
 Prepunched
 Envelope
 Cardstock
 Thick
 High Quality
 CUSTOM 1 to 8

- 5** Press Δ or ∇ to select the desired media type.

- 6** Press **[OK]**. The media type for the MP tray is set and the **MP Tray Set.** menu screen reappears.

Cassette (1 to 5) Set. (Settings for the cassettes)

To print correctly on paper supplied from the cassettes, use the procedure below to set the paper size and media type.

Set the cassette according to the paper size.

- Setting the standard paper size...4-32
- Setting the non-standard paper size...4-34

The options available in **Cassette (1 to 5) Set.** menu are as follows:

- Media Type (Setting the cassette paper type)...4-33
- Other Paper Size (Setting the Paper Size from the Operation Panel)...4-34
- Custom PaperSize (Setting a Custom Paper Size)...4-35

Setting the standard paper size

To set the standard sizes A5, A4, B5, Letter, Legal and A6 (paper cassette), the following operations are necessary.

- Setting the cassette paper size...4-33
- Media Type (Setting the cassette paper type)...4-33

Setting the cassette paper size

To set the standard sizes for the paper cassette, load the paper and turn the paper size dial so that the size of the paper you are going to use appears in the paper size window. To adjust the paper width guides and the paper length guide of the paper cassette, refer to *Loading Paper into the Cassette on page 2-38*.

If the PF-320 optional paper feeder is installed, use the same procedure to load paper into the paper feeder cassettes.

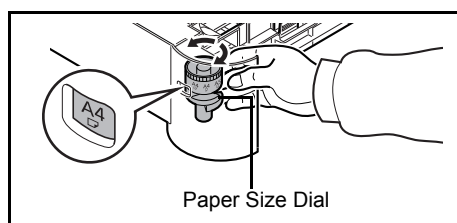

- 1 Pull the cassette out of the printer and set the paper size using the paper size dial.

- 2 Adjust the paper guides in the cassette to the size of the paper to be used for printing and load the paper into the cassette.

Media Type (Setting the cassette paper type)

By setting a paper type (plain, recycled, etc.) for the paper cassette, you can automatically select the paper in the paper cassette according to the paper type you command on the printer driver.

If the PF-320 optional paper feeder is installed, use the same procedure to setting the cassette paper type.

For more information about paper types that you can feed from the paper cassette, refer to *Paper Specifications on page A-11*.

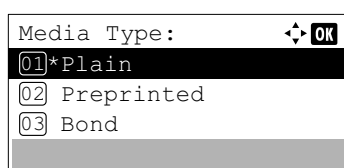
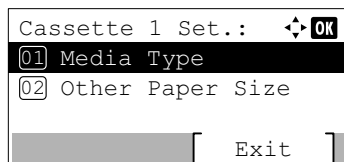

- 1 In the Paper Settings menu, press Δ or ∇ to select the cassette you want to set.
- 2 Press [OK]. The Cassette # Set. menu screen appears.
shows the number of the cassette installed in the printer (1 to 5).

- 3 Press Δ or ∇ to select Media Type.
- 4 Press [OK]. The Media Type screen appears listing the media types that can be used with the selected cassette.

The available Media Types are as follows:

Plain
Preprinted
Bond
Recycled
Rough
Letterhead
Color
Prepunched
High Quality
CUSTOM 1 to 8

- 5 Press Δ or ∇ to select the desired media type.
- 6 Press [OK]. The media type for the cassette is set and the Cassette # Set. menu screen reappears.

Setting the non-standard paper size

To set the non-standard sizes (sizes other than A5, A4, B5, Letter, Legal and A6 (paper cassette), the following operations are necessary.

- Selecting the Size Dial Setting...4-34
- Other Paper Size (Setting the Paper Size from the Operation Panel)...4-34
- Custom PaperSize (Setting a Custom Paper Size)...4-35
- Media Type (Setting the cassette paper type)...4-37

Selecting the Size Dial Setting

- 1 Pull the cassette out of the printer and set the paper size dial to **Other**. For details, refer to step 1 in *Setting the cassette paper size on page 4-33*.
- 2 Adjust the paper guides in the cassette to the size of the paper to be used for printing and load the paper into the cassette.

Other Paper Size (Setting the Paper Size from the Operation Panel)

Use the operation panel to set the size of paper loaded in the cassette on the printer.

 **Note** When `Custom` is selected, it is possible to enter the paper size. For details, refer to *Custom PaperSize (Setting a Custom Paper Size) on page 4-35*.

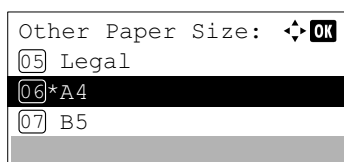
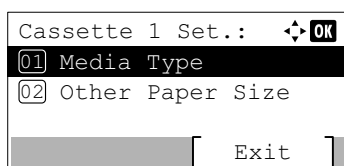

- 1 In the `Paper Settings` menu, press Δ or ∇ to select the paper cassette assigned to `Other` on the Size Dial.
- 2 Press **[OK]**. The `Cassette # Set.` menu screen appears.
shows the number of the cassette installed in the printer (1 to 5).
- 3 Press Δ or ∇ to select `Other Paper Size`.
- 4 Press **[OK]**. The `Other Paper Size` screen appears listing the paper sizes that can be used in the cassette.

The available paper sizes are as follows:

Envelope Monarch (#1)
Envelope #10 (#1)
Envelope DL (#1)
Envelope C5 (#1)
Executive
Letter
Legal
A4
B5
A5-R
A5
A6 (#2)
B6 (#3)
Envelope #9 (#1)
Envelope #6 (#1)
ISO B5
Custom

Oufuku Hagaki (#3)
 Oficio II
 216x340mm
 16K
 Statement
 Folio
 Youkei 2 (#1)
 Youkei 4 (#1)

#1 Only when optional paper feeder PF-320 is installed.

#2 Cassette 1 for the ECOSYS P3050dn, ECOSYS P3055dn and ECOSYS P3060dn.

#3 Cassette 1 except for the ECOSYS P3045dn.

5 Press Δ or ∇ to select the desired paper size.



Note When *Custom* is selected, it is possible to enter the paper size. For details, refer to *Custom PaperSize (Setting a Custom Paper Size)* on page 4-35.

6 Press [OK]. The paper size for the cassette is set and the *Cassette # Set.* menu screen reappears.

If you selected *Custom* in step 4, use the procedure below to specify the paper length and width.

Custom PaperSize (Setting a Custom Paper Size)

In the procedure below, select the units to be used for entering the custom paper size and then enter the paper width and length. As shown in the figure, enter the Y and X values for the paper size, using the selected units.

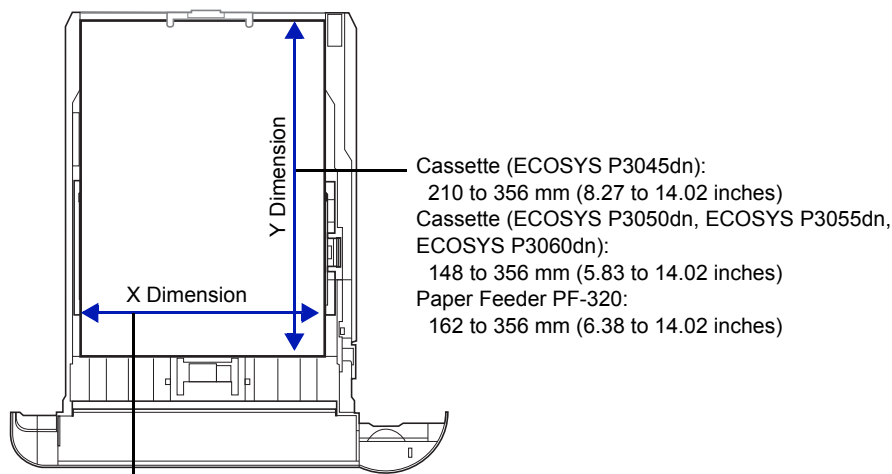

Cassette (ECOSYS P3045dn):

140 to 216 mm (5.51 to 8.50 inches)

Cassette (ECOSYS P3050dn, ECOSYS P3055dn, ECOSYS P3060dn):

105 to 216 mm (4.13 to 8.50 inches)

Paper Feeder PF-320:

92 to 216 mm (3.62 to 8.50 inches)

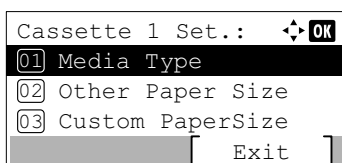

1 In the *Cassette # Set.* menu, press Δ or ∇ to select *Custom PaperSize*.

shows the number of the cassette installed in the printer (1 to 5).

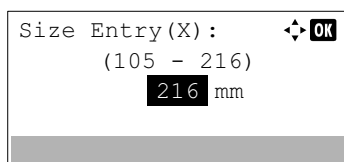
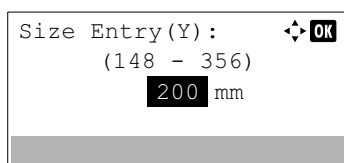
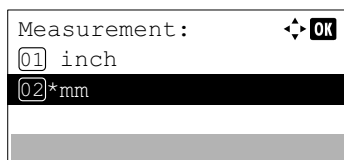
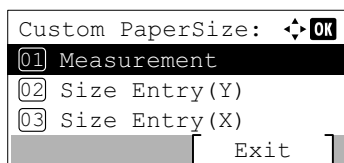

2 Press **[OK]**. The Custom PaperSize menu screen appears.

3 Press Δ or ∇ to select Measurement.

4 Press **[OK]**. The Measurement menu screen appears.

5 Press Δ or ∇ to select the paper size units and then press **[OK]**. The unit for entering the paper size is set and the Custom PaperSize menu screen reappears.

6 Press Δ or ∇ to select Size Entry (Y).

7 Press **[OK]**. The Size Entry (Y) menu screen appears.

8 Use the numeric keys or press Δ or ∇ to enter the paper length.

The range of paper lengths you can set for each cassette is as follows:

- Cassette (ECOSYS P3045dn):
210 to 356 mm (8.27 to 14.02 inches)
- Cassette (ECOSYS P3050dn, ECOSYS P3055dn, ECOSYS P3060dn):
148 to 356 mm (5.83 to 14.02 inches)
- Paper Feeder PF-320:
162 to 356 mm (6.38 to 14.02 inches)

9 Press **[OK]**. The entered paper length is set and the Custom PaperSize menu screen reappears.

10 Press Δ or ∇ to select Size Entry (X).

11 Press **[OK]**. The Size Entry (X) menu screen appears.

12 Use the numeric keys or Δ or ∇ to enter the paper width.

The range of paper widths you can set for each cassette is as follows:

- Cassette (ECOSYS P3045dn):
140 to 216 mm (5.51 to 8.50 inches)
- Cassette (ECOSYS P3050dn, ECOSYS P3055dn, ECOSYS P3060dn):
105 to 216 mm (4.13 to 8.50 inches)
- Paper Feeder PF-320:
92 to 216 mm (3.62 to 8.50 inches)

- 13 Press **[OK]**. The entered paper width is set and the *Custom PaperSize* menu screen reappears.
- 14 Pressing **[Exit]** (**[Right Select]**) returns to the Ready to print screen.

Media Type (Setting the cassette paper type)

To set the paper type for the paper cassette, refer to *Media Type (Setting the cassette paper type) on page 4-33*.

Bulk Feeder Set. (Settings for the optional bulk paper feeder)

To print correctly on paper supplied from the optional bulk paper feeder, use the procedure below to set the paper size and media type.



Note Bulk Feeder Set. is displayed only when the optional bulk paper feeder is installed on the printer.

The options available in Bulk Feeder Set. menu are as follows:

- Paper Size (Paper size setting for the optional bulk paper feeder)...4-37
- Media Type (Paper type setting for the optional bulk paper feeder)...4-38

Paper Size (Paper size setting for the optional bulk paper feeder)

You can use this to set the paper size that can be supplied from the optional bulk paper feeder.

- 1 In the Paper Settings menu, press Δ or ∇ to select Bulk Feeder Set..
- 2 Press **[OK]**. The Bulk Feeder Set. menu screen appears.
- 3 Press Δ or ∇ to select Paper Size.
- 4 Press **[OK]**. The Paper Size screen appears listing the paper sizes that can be supplied from the bulk paper feeder.

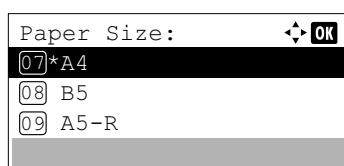
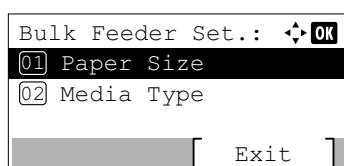

The available paper sizes are as follows:

Envelope Monarch
 Envelope #10
 Envelope DL
 Envelope C5
 Executive
 Letter
 A4
 B5
 A5-R
 A6
 B6
 Envelope #9
 Envelope #6
 ISO B5
 Custom
 Hagaki

Oufuku Hagaki
 16K
 Statement
 Youkei 2
 Youkei 4

- 5** Press Δ or ∇ to select the desired paper size.
- 6** Press **[OK]**. The paper size for the bulk paper feeder is set and the Bulk Feeder Set. menu screen reappears.

Media Type (Paper type setting for the optional bulk paper feeder)

You can use this to set the paper type that can be supplied from the optional bulk paper feeder.

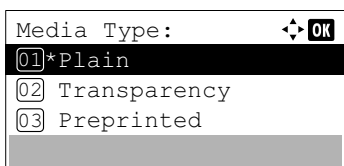
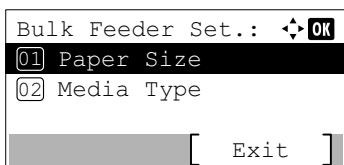

- 1** In the Paper Settings menu, press Δ or ∇ to select Bulk Feeder Set..
- 2** Press **[OK]**. The Bulk Feeder Set. menu screen appears.
- 3** Press Δ or ∇ to select Media Type.
- 4** Press **[OK]**. The Media Type screen appears listing the media types that can be supplied from the bulk paper feeder.

The available media types are as follows:

Plain
 Transparency
 Preprinted
 Labels
 Bond
 Recycled
 Vellum
 Rough
 Letterhead
 Color
 Prepunched
 Envelope
 Cardstock
 Thick
 High Quality
 CUSTOM 1 to 8

- 5** Press Δ or ∇ to select the desired media type.
- 6** Press **[OK]**. The media type for the bulk paper feeder is set and the Bulk Feeder Set. menu screen reappears.

Media Type Set. (Paper type settings)

You can set the paper thickness by selecting a paper weight. This allows you to set the paper thickness for each of the media types that can be used on the printer. And for custom paper registered in the printer (up to 8), you can specify paper thickness and whether duplex printing is permitted. (For the procedure for registering custom paper sizes, refer to *Custom PaperSize (Setting a Custom Paper Size)* on page 4-35.)

For normal settings, refer to *Setting the Paper Thickness* on page 4-39. For custom paper settings, refer to *Custom Paper Settings* on page 4-40.

The options available in Media Type Set. menu are as follows:

- Setting the Paper Thickness...4-39
- Custom Paper Settings...4-40

Setting the Paper Thickness

You can set the paper thickness by selecting a paper weight.

The available paper weights are as follows:

- Extra Heavy
- Heavy 3
- Heavy 2
- Heavy 1
- Normal 3
- Normal 2
- Normal 1
- Light

Each media type's default weight is indicated.

Media Type	Paper Weight	Media Type	Paper Weight
Plain	Normal 2	Letterhead	Normal 2
Transparency	Extra Heavy	Color	Normal 2
Preprinted	Normal 2	Prepunched	Normal 2
Labels	Heavy 1	Envelope [†]	Heavy 3
Bond	Normal 3	Cardstock	Heavy 3
Recycled	Normal 2	Thick	Heavy 3
Vellum	Light	HighQuality	Normal 2
Rough	Normal 2	CUSTOM 1 to 8	Normal 2

[†] The processing speed will be slower than normal.

 **Note** Depending on the type of paper, the toner may not adhere to the paper properly. To solve this problem, select the half speed mode from the printer driver. For more information, refer to *Half Speed Mode (Printer Driver Settings)* on page 3-8.

Use the procedure below to set the paper weight.

(For the procedure for setting weights for custom paper (CUSTOM 1 to 8), refer to *Custom Paper Settings* on page 4-40.)

- 1 In the Paper Settings menu, press Δ or ∇ to select Media Type Set..

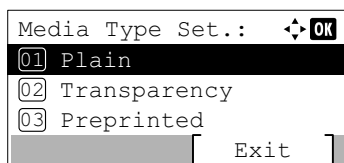

- Press **[OK]**. The `Media Type Set.` screen appears listing the media types that can be used with the printer.

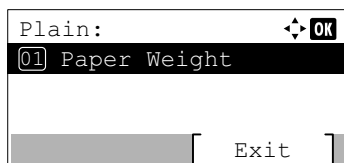

- Press Δ or ∇ to select the media type for which you want to set the paper weight.
- Press **[OK]**. A menu for the selected media is displayed.

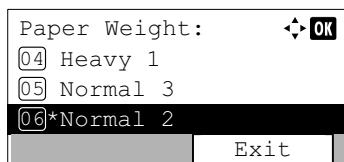

- Press Δ or ∇ to select `Paper Weight`.
- Press **[OK]**. The `Paper Weight` screen appears listing the paper weights that can be used with the printer.
- Press Δ or ∇ to select the desired paper weight.
- Press **[OK]**. The paper weight is set and the `Media Type Set.` screen reappears.

Custom Paper Settings

This setting specifies the paper weight of the selected custom paper, whether duplex printing is permitted and the registration of the name to be displayed.

Use the procedure below to set the custom paper weight.

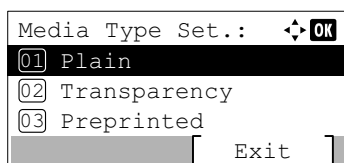

- In the `Paper Settings` menu, press Δ or ∇ to select `Media Type Set..`
- Press **[OK]**. The `Media Type Set.` screen appears listing the media types that can be used with the printer.

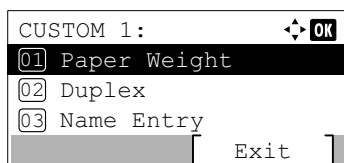

- Press Δ or ∇ to select the custom paper (CUSTOM 1 to 8) for which you want to set the paper weight.
- Press **[OK]**. A menu for the selected media is displayed.
- Press Δ or ∇ to select `Paper Weight`.

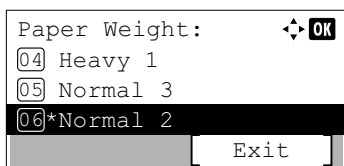

6 Press **[OK]**. The Paper Weight screen appears listing the paper weights that can used with the printer.

7 Press Δ or ∇ to select the desired paper weight.

8 Press **[OK]**. The paper weight is set and the custom paper screen reappears.

Use the procedure below to specify whether duplex printing is permitted with custom paper.

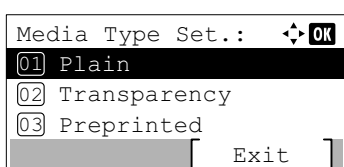

1 In the Paper Settings menu, press Δ or ∇ to select Media Type Set..

2 Press **[OK]**. The Media Type Set. screen appears listing the media types that can used with the printer.

3 Press Δ or ∇ to select the custom paper (CUSTOM 1 to 8) for which you want to set the duplex printing permission.

4 Press **[OK]**. A menu for the selected media is displayed.

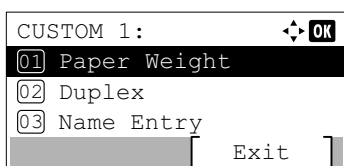

5 Press Δ or ∇ to select Duplex.

6 Press **[OK]**. The Duplex screen appears listing the paper weights that can used with the printer.

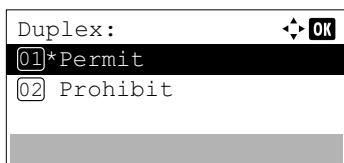

7 Press Δ or ∇ to specify whether duplex printing is permitted.

8 Press **[OK]**. The duplex printing permission is set and the custom paper screen reappears.

Use the procedure below to register the name to be displayed for the custom paper.

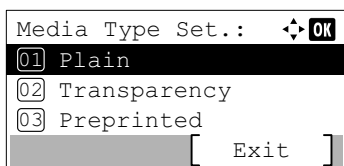

1 In the Paper Settings menu, press Δ or ∇ to select Media Type Set..

2 Press **[OK]**. The Media Type Set. screen appears listing the media types that can used with the printer.

3 Press Δ or ∇ to select the custom paper (CUSTOM 1 to 8) for which you want to register a name to display.

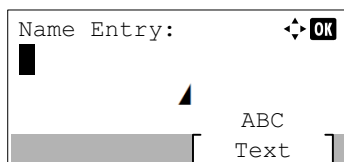
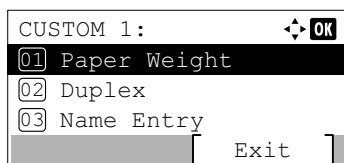

4 Press **[OK]**. A menu for the selected media is displayed.

5 Press Δ or ∇ to select `Name Entry`.

6 Press **[OK]**. The `Name Entry` screen appears.

7 Use the numeric keys to enter the name to display for the custom paper.



Note Up to 16 characters can be entered. For details on entering characters, refer to *Character Entry Method on page A-2*.

8 Press **[OK]**. Register the name to display and the renamed custom paper screen reappears.

Reset Type Adj. (Resets customized settings)

This resets all the settings specified in *Media Type Set. (Paper type settings) on page 4-39*.

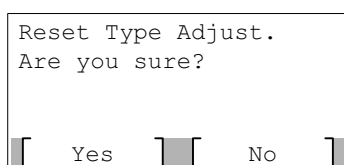

1 In the `Paper Settings` menu, press Δ or ∇ to select `Reset Type Adj..`

2 Press **[OK]**. A confirmation screen appears.

3 Press `[Yes]` (**[Left Select]**). The message `Completed.` appears and the `Paper Settings` menu reappears.

Pressing `[No]` (**[Right Select]**) returns to the `Paper Settings` menu without resetting the customized settings.

Paper Setup Msg(Check setting when loading paper)

Set whether to display the confirmation screen for the paper setting when a new paper is set for each cassette.

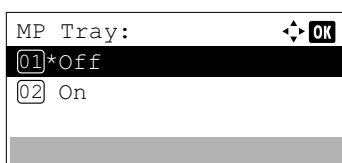
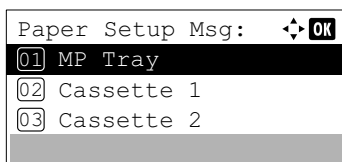

- 1** In the Paper Setup menu, press Δ or ∇ to select Paper Setup Msg.
- 2** Press **[OK]**. The Paper Setup Msg menu screen appears.
- 3** In the Paper Setup Msg menu, press Δ or ∇ to select the MP Tray or cassette you want to set.
- 4** Press **[OK]**. The MP Tray screen or Cassette # screen appears.
- 5** Press Δ or ∇ to select On or Off.
Press **[OK]**. The Paper Setup Msg setting is set and the Paper Setup Msg menu screen reappears.

Print Settings

These settings specify the following printing parameters: paper feed source, paper feed mode, duplex printing, override A4/LTR, emulation mode, print quality, and setting pagination.

The options available in Print Settings are as follows:

- Paper Source (Selecting the paper feed source)...4-44
- Auto Cass. Change (Auto Cassette Change setting)...4-45
- MP Tray Priority (the settings for priority paper feed from the MP tray)...4-45
- Paper Feed Mode (Setting the paper feed source)...4-46
- Duplex (Setting the duplex printing)...4-46
- Paper Output (Selecting the output stack)...4-47
- Override A4/LTR (Overriding difference between A4 and Letter)...4-48
- Emulation (Setting the emulation)...4-48
- Font (Selecting the default font)...4-50
- Code Set (Setting the code set)...4-52
- Print Quality (Setting print quality)...4-53
- Page Setting (Setting pagination)...4-55
- User Name (The User Name display settings)...4-59
- Job Name (The Job Name display settings)...4-59
- Job Terminator (Job Terminator settings)...4-60

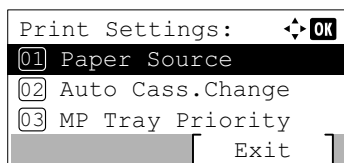

- 1 Press **[Menu]**.
- 2 Press Δ or ∇ to select `Print Settings`.

- 3 Press **[OK]**. The `Print Settings` menu appears showing a list of available options.

Paper Source (Selecting the paper feed source)

You can select the paper source from which the printer feeds paper as the default. If an optional paper feeder(s) is installed, it can also be set the default paper source.

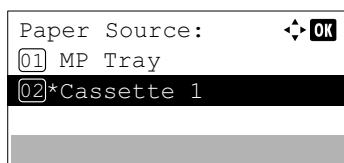

- 1 In the `Print Settings` menu, press Δ or ∇ to select `Paper Source`.
- 2 Press **[OK]**. The `Paper Source` screen appears showing a list of the available paper sources.

The available paper sources are as follows:

MP Tray

Cassette 1 (printer's standard paper cassette)

Cassette 2 to 5 (optional paper feeders (only installed paper feeders are shown))

- 3 Press Δ or ∇ to select the desired paper source.
- 4 Press **[OK]**. The paper source is set and the `Print Settings` menu reappears.

Auto Cass. Change (Auto Cassette Change setting)

You can select the following actions when the paper runs out in the paper source while printing.

Off	The printer displays Load paper cassette #. (# is a cassette number) or Load paper in MP Tray, and stops printing. Load the paper according to the paper source displayed to resume printing. To print from the other cassette, press [Alt.] ([Left Select]). Press Δ or ∇ to select the desired paper source, and then press [OK].
On	The printer continues printing automatically when the other cassette contains the same paper as the currently used paper cassette.

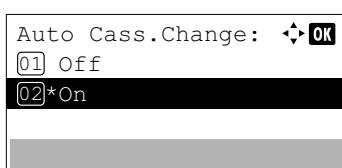

- 1 In the Print Settings menu, press Δ or ∇ to select Auto Cass. Change.
- 2 Press [OK]. The Auto Cass. Change screen appears showing the auto cassette change settings.
- 3 Press Δ or ∇ to select Off or On.
- 4 Press [OK]. The auto cassette change is set and the Print Settings menu reappears.



Note You can also configure the Auto Cassette Change in the Command Center RX. Access to the Command Center RX, and then go to **Function Settings > Printer** page. For more information on access to the Command Center RX, refer to the *Command Center RX User Guide*.

MP Tray Priority (the settings for priority paper feed from the MP tray)

If paper is set in the MP Tray then it is possible for priority to be given to that MP tray in the paper feed.

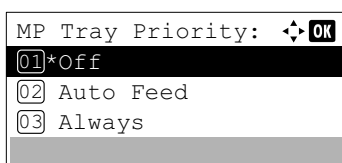

- 1 In the Print Settings menu, press Δ or ∇ to select MP Tray Priority.
- 2 Press [OK]. The MP Tray Priority screen appears showing the available MP tray priority mode options.
Off (The printer driver settings are followed.)
Auto Feed (If Auto is selected in the printer driver and there is paper in the MP tray then the paper feed will be from the MP tray.)
Always (If there is paper in the MP tray then the paper feed will be from the MP tray regardless of what is set in the printer driver.)
- 3 Press Δ or ∇ to select the desired MP tray priority mode.
- 4 Press [OK]. The MP tray priority mode is set and the Print Settings menu reappears.

Paper Feed Mode (Setting the paper feed source)

This mode specifies how the paper should be fed once the paper feed source and paper type have been chosen. If `Auto` is selected, the printer searches for a paper feed source that matches the paper size and type, and paper is then delivered from that source. If `Fixed` is selected and there is no matching paper feed source, handling proceeds as specified by `Paper Mismatch for Error Handling`. For details on paper feeding when `Fixed` is selected, refer to *Paper Mismatch (Detection settings for paper size/type errors when the paper source is fixed)* on page 4-104. To change the settings, follow the steps described below.

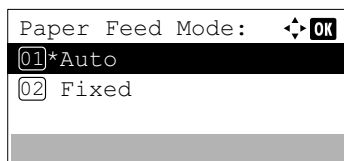

- 1 In the `Print Settings` menu, press Δ or ∇ to select `Paper Feed Mode`.
- 2 Press **[OK]**. The `Paper Feed Mode` screen appears showing the available paper feed options.
- 3 Press Δ or ∇ to select the desired paper feed mode.
- 4 Press **[OK]**. The paper feed mode is set and the `Print Settings` menu reappears.

Duplex (Setting the duplex printing)

Using the duplexer, you can automatically print on both sides of the paper.

Duplex printing is available for the following paper (media) types:

Plain
 Preprinted
 Bond
 Recycled
 Rough
 Letterhead
 Color
 Prepunched
 High Quality
 Custom 1 to 8

 **Note** Duplex printing can be also performed from the MP tray. If the paper to be fed from the MP tray does not match the paper size and paper type of the current paper feed source cassette, a paper jam may occur.

When `Custom` is specified, duplex printing can be set. For details, refer to *Custom Paper Settings* on page 4-40.

Binding Modes

Binding refers to the manner in which printed pages of paper are joined together (by gluing, stitching, etc.) in book form. The two possible types of binding are: Bind Long Edge, in which pages are joined together along their long edge; and Bind Short Edge, in which they are joined together along their short edge. In selecting a binding type, you must also consider the orientation of the printed page. You can use Bind Long Edge or Bind Short Edge with either landscape or portrait printing.

Depending on the binding type and print orientation, the duplexer provides four types of binding. These are: (1) portrait, Bind Long Edge, (2) portrait, Bind Short Edge, (3) landscape, Bind Long Edge, and (4) landscape, Bind Short Edge. The figure below shows these binding methods.

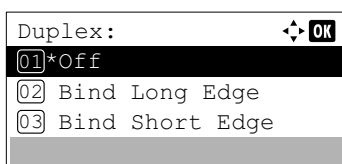
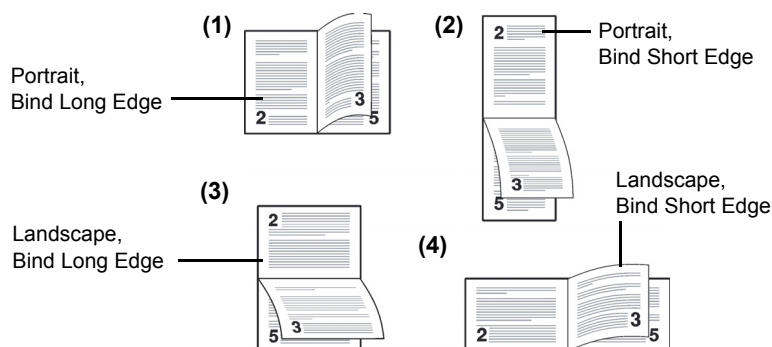

- 1 In the `Print Settings` menu, press Δ or ∇ to select `Duplex`.
- 2 Press **[OK]**. The `Duplex` screen appears showing the list of available duplex printing modes.

- 3 Press Δ or ∇ to select the desired duplex printing mode.

The message display toggles through the following:

- Off
- Bind Long Edge
- Bind Short Edge

Selecting `Off` disables duplex printing.

- 4 Press **[OK]**. The duplex printing mode is set and the `Print Settings` menu reappears.

Paper Output (Selecting the output stack)

The Paper Output menu on the operation panel allows you to select either the face-down tray or the faceup tray option for the output stack.



Note This menu can be used for ECOSYS P3050dn, ECOSYS P3055dn and ECOSYS P3060dn.

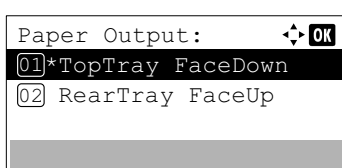

- 1 In the `Print Settings` menu, press Δ or ∇ to select `Paper Output`.
- 2 Press **[OK]**. The `Paper Output` screen appears.

- 3 Press Δ or ∇ to select output stack - TopTray FaceDown or Rear Tray FaceUp.
- 4 Press [OK]. The output stack is set and the Print Settings menu reappears.

Override A4/LTR (Overriding difference between A4 and Letter)

When the Override A4/LTR is turned On using the operation panel, the printer ignores the difference between A4 and Letter paper sizes. Printing is performed without an error message even if the actual paper size in the current cassette differs from the paper size formatting the job.

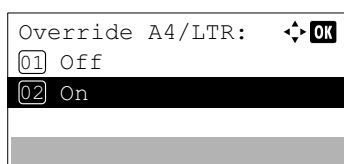

- 1 In the Print Settings menu, press Δ or ∇ to select Override A4/LTR.
- 2 Press [OK]. The Override A4/LTR screen appears.
- 3 Press Δ or ∇ to select Off or On.
- 4 Press [OK]. The Print Settings menu reappears.

Emulation (Setting the emulation)

You can change the emulation mode. Use the procedure below to select the mode.



Note To print the PDF file using FTP printing, set emulation to KPDL.

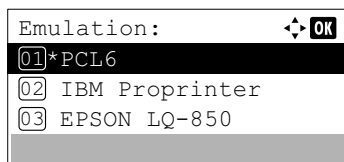
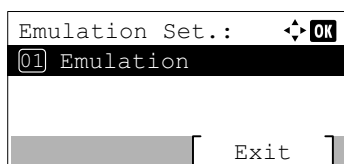

- 1 In the Print Settings menu, press Δ or ∇ to select Emulation Set..
- 2 Press [OK]. The Emulation Set. menu screen appears.
- 3 Press Δ or ∇ to select Emulation.
- 4 Press [OK]. The Emulation screen appears showing a list of the available emulations. The defaults differ depending on the delivery destination.

The available emulations are as follows:

PCL6
 IBM Proprinter
 EPSON LQ-850
 Line Printer
 KPDL
 KPDL (Auto)

- 5 Press Δ or ∇ to select the desired emulation.
- 6 Press [OK]. The emulation is set and the Emulation Set. menu reappears.

KPDL Error Rpt. (Printing KPDL errors)

The printer can print error descriptions when printing error occurs during KPDL emulation.

IMPORTANT This setting only appears when **KPDL** or **KPDL (Auto)** is selected for the emulation.

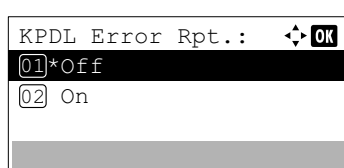
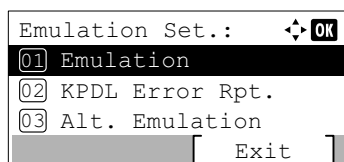

- 1 In the **Print Settings** menu, press Δ or ∇ to select **Emulation Set..**
- 2 Press **[OK]**. The **Emulation Set.** menu screen appears.
- 3 Press Δ or ∇ to select **KPDL Error Rpt..**
- 4 Press **[OK]**. The **KPDL Error Rpt.** screen appears.
- 5 Press Δ or ∇ to select whether error reports are printed.
- 6 Press **[OK]**. The error report print setting is set and the **Emulation Set.** menu reappears.

Alt. Emulation (Alternative Emulation for KPDL Emulation)

The **KPDL (AUTO)** emulation enables the printer to automatically change the emulation mode according to the data received when printing.

IMPORTANT This setting only appears when **KPDL (Auto)** is selected for the emulation.

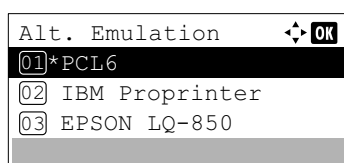
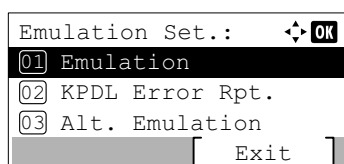

- 1 In the **Print Settings** menu, press Δ or ∇ to select **Emulation Set..**
- 2 Press **[OK]**. The **Emulation Set.** menu screen appears.
- 3 Press Δ or ∇ to select **Alt. Emulation.**
- 4 Press **[OK]**. The **Alt. Emulation** screen appears showing a list of the available alternative emulations.
The available alternative emulations are as follows:
PCL6
IBM Proprinter
EPSON LQ-850
Line Printer
- 5 Press Δ or ∇ to select the desired alternative emulation.
- 6 Press **[OK]**. The alternative emulation is set and the **Emulation Set.** menu reappears.

Font (Selecting the default font)

You can select the default font. The default font can be one of the internal fonts or a font that is downloaded to the printer memory or stored on SD card, or SSD.

In this menu, you can also set the type and pitch for Courier and Letter Gothic.

The options available in Font menu are as follows:

- Selecting Regular or Dark Courier/Letter Gothic...4-51
- Changing the Default Font Size...4-51
- Character Pitch...4-52

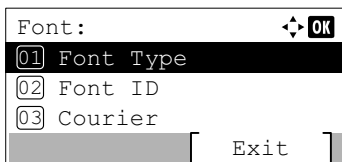
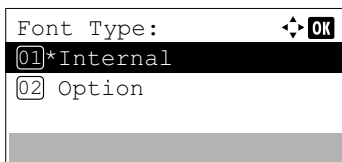
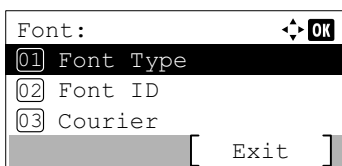

1 In the `Print Settings` menu, press Δ or ∇ to select `Font`.

2 Press **[OK]**. The `Font` menu screen appears.

3 Press Δ or ∇ to select `Font Type`.

4 Press **[OK]**. The `Font Type` screen appears.

5 To select a font built-in the printer, press Δ or ∇ to select `Internal`.

6 Press **[OK]**. Select the font type and the `Font` menu reappears.

7 Press Δ or ∇ to select `Font ID`.

8 Press **[OK]**. The `Font ID` entry screen appears.

9 Press Δ or ∇ to select the number of the desired font.



Note It is possible to check the numbers of the built-in fonts by outputting a `Font List`. For details, refer to *Font List* (*Printing a list of the printer's fonts*) on page 4-14.

To select optional fonts other than those built-in, select `Option` in step 5. You can perform this operation only when optional fonts are installed in the printer.

The letter before the number indicates the location of the font, as shown below.

I: Internal font

S: Soft (downloaded) font

M: Fonts in optional SD card

H: Fonts in RAM disk or optional SSD

10 Press **[OK]**. The default font is set and the **Font** menu reappears.

Selecting Regular or Dark Courier/Letter Gothic

Courier or Letter Gothic font thickness can be selected as **Regular** or **Dark**. In the procedure below, it is assumed that **Courier** is selected. The procedure is the same for **Letter Gothic**.

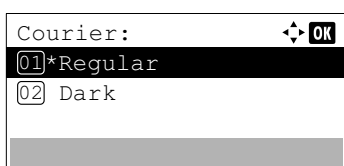
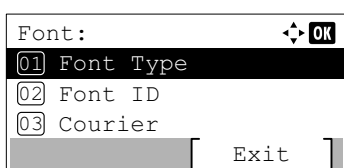

1 In the **Print Settings** menu, press Δ or ∇ to select **Font**.

2 Press **[OK]**. The **Font** menu screen appears.

3 Press Δ or ∇ to select **Courier**. If you are selecting the thickness of the **Letter Gothic** font, choose **Letter Gothic** here instead.

4 Press **[OK]**. The **Courier** screen appears.

5 Press Δ or ∇ to select **Regular** or **Dark**.

6 Press **[OK]**. The font thickness is set and the **Font** menu reappears.

Changing the Default Font Size

You can change the size of the default font. If you selected a proportional font, the character size can be changed.

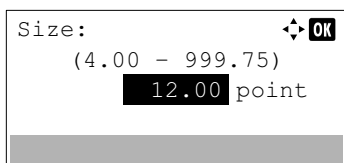
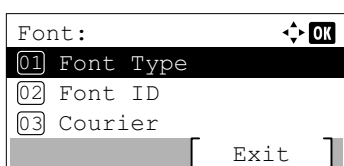

1 In the **Print Settings** menu, press Δ or ∇ to select **Font**.

2 Press **[OK]**. The **Font** menu screen appears.

3 Press Δ or ∇ to select **Size**.

4 Press **[OK]**. The **Size** entry screen appears.

5 Press Δ or ∇ to enter the font size.

 **Note** The font size can be set between 4.00 and 999.75 points, in 0.25-point increments.

Character Pitch

You can set the character pitch for fixed fonts.

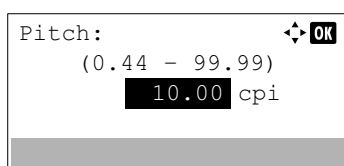
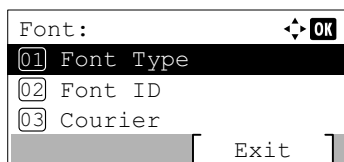

6 Press **[OK]**. The font size is set and the `Font` menu reappears.

1 In the `Print Settings` menu, press Δ or ∇ to select `Font`.

2 Press **[OK]**. The `Font` menu screen appears.

3 Press Δ or ∇ to select `Pitch`.

4 Press **[OK]**. The `Pitch` entry screen appears.

5 Use the numeric keys or press Δ or ∇ to enter the character pitch.



Note The character pitch can be set between 0.44 and 99.99 characters per inch, in 0.01 character-per-inch increments.

6 Press **[OK]**. The character pitch is set and the `Font` menu reappears.

Code Set (Setting the code set)

You can change the character code set. Available character code sets vary depending on the current font.

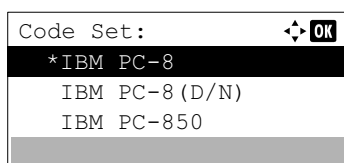

1 In the `Print Settings` menu, press Δ or ∇ to select `Code Set`.

2 Press **[OK]**. The `Code Set` screen appears listing the available character code sets.

3 Press Δ or ∇ to select the desired character code set.

4 Press **[OK]**. The character code set is set and the `Print Settings` menu reappears.

Print Quality (Setting print quality)

In Print Quality menus, you can set the KIR mode, EcoPrint mode, and other settings.

The options available in Print Quality are as follows:

- KIR (Selecting the KIR mode)...4-53
- EcoPrint (Selecting the EcoPrint mode)...4-53
- Print Resolution (Selecting the Print Resolution)...4-54
- Print Density (Selecting the Print Density)...4-54

- 1 In the `Print Settings` menu, press Δ or ∇ to select `Print Quality`.
- 2 Press **[OK]**. The `Print Quality` menu screen appears.

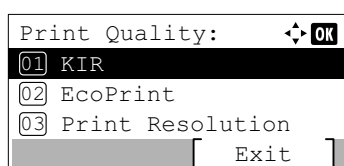

KIR (Selecting the KIR mode)

This printer incorporates the KIR (Kyocera Image Refinement) smoothing function. KIR uses the software to enhance resolution, resulting in high quality printing at resolution of 600 dpi and 300 dpi. KIR has no effect on the printing speed.

- 1 In the `Print Quality` menu, press Δ or ∇ to select `KIR`.
- 2 Press **[OK]**. The `KIR` screen appears.

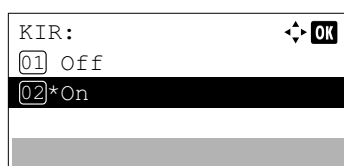

- 3 Press Δ or ∇ to select whether the KIR mode is enabled.
- 4 Press **[OK]**. The KIR mode is set and the `Print Quality` menu screen reappears.

EcoPrint (Selecting the EcoPrint mode)

By enabling EcoPrint mode, you can minimize the amount of toner used during printing. Because images printed in this mode may be slightly coarser than those printed in standard resolution, you should use EcoPrint for test prints or other situations where high-quality prints are not required. EcoPrint has no effect on the printing speed.

Use the procedure below to select EcoPrint mode.

- 1 In the `Print Quality` menu, press Δ or ∇ to select `EcoPrint`.
- 2 Press **[OK]**. The `EcoPrint` screen appears.

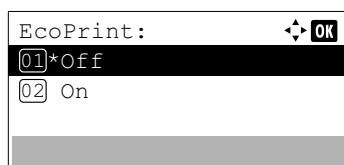

- 3 Press Δ or ∇ to select whether the EcoPrint mode is enabled.
- 4 Press **[OK]**. The EcoPrint mode is set and the `Print Quality` menu screen reappears.

Print Resolution (Selecting the Print Resolution)

You can set the default print resolution in four ways: 300dpi, 600dpi, Fast1200 and Fine1200. The clarity of printed characters and graphics becomes sharper in this order.

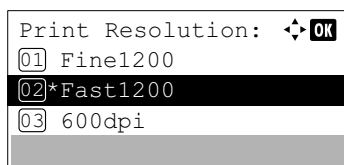

- 1** In the `Print Quality` menu, press Δ or ∇ to select `Print Resolution`.
- 2** Press **[OK]**. The `Print Resolution` screen appears.
- 3** Press Δ or ∇ to select the `Print Resolution`.
- 4** Press **[OK]**. The `Print Resolution` is set and the `Print Quality` menu screen reappears.

Print Density (Selecting the Print Density)

The print density can be adjusted in five steps: from 1 `Lighter` to 5 `Darker`.

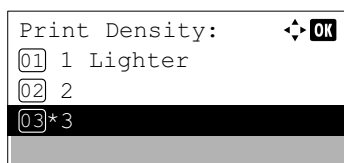

- 1** In the `Print Quality` menu, press Δ or ∇ to select `Print Density`.
- 2** Press **[OK]**. The `Print Density` screen appears.
- 3** Press Δ or ∇ to select the print density from five steps from 1 `Lighter` to 5 `Darker`.
- 4** Press **[OK]**. The print density is set and the `Print Quality` menu screen reappears.

Page Setting (Setting pagination)

You can use the Page Setting menu to set the number of copies, the page orientation and other pagination settings.

The options available in Page Setting are as follows:

- Copies (Number of copies)...4-55
- Reduced Print (Reduced print settings)...4-55
- Orientation (Print orientation)...4-57
- LF Action (Linefeed)...4-57
- CR Action (Carriage-Return)...4-58
- Wide A4 (Wide A4 pitch)...4-58
- XPS FitTo Page (Adjusting the XPS file print out size)...4-58
- TIFF/JPEG Size (Adjusting the TIFF/JPEG file print out size)...4-58

- 1 In the `Print Settings` menu, press Δ or ∇ to select `Page Setting`.
- 2 Press **[OK]**. The `Page Setting` menu screen appears.

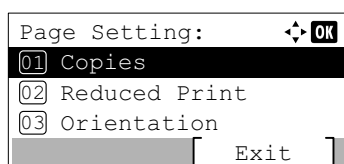

Copies (Number of copies)

You can set the number of copies of each page to be printed.

- 1 In the `Page Setting` menu, press Δ or ∇ to select `Copies`.
- 2 Press **[OK]**. The `Copies` screen appears.

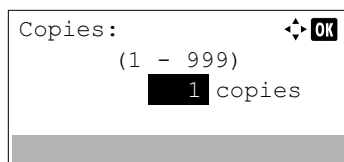

- 3 Use the numeric keys or press Δ or ∇ to set the number of copies.
- 4 Press **[OK]**. The setting is stored and the `Page Setting` menu reappears.

Reduced Print (Reduced print settings)

This selects the settings for reducing the size of the print data and printing it (Reduced Print). Set the paper size before the reduction and set the reduction ratio.



Note With Reduced Print, the results may differ from the results of same size printing. The character line width may not be constant and lines may appear in the middle of figures, images or patterns. Also, thin lines, etc., may not be printed. Furthermore, it may not be possible to read barcodes that have been printed with Reduced Print.

- 1 In the `Page Setting` menu, press Δ or ∇ to select `Reduced Print`.

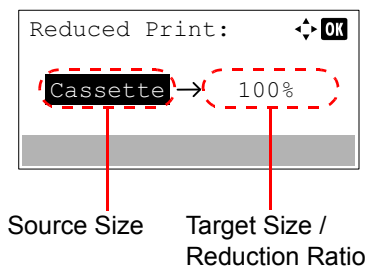

2 Press [OK]. The Reduced Print screen appears.

Reduced Print is displayed as follows.

Source Size: This is the paper size before the reduction. This must be the same as the paper size set in the print data.

Target Size / Reduction Ratio: This is the paper size after reduction or the reduction ratio. It is displayed with either the paper size or the reduction ratio.

Refer to the table below for the possible settings for the combination of Source Size and Target Size / Reduction Ratio.

Source Size	Target Size / Reduction Ratio
Cassette	100%
	98%
Legal	100%
	98%
Letter	100%
	A4
	98%
Oficio II	100%
Folio	100%
16K	100%
A5	100%
	98%
B5	100%
	A5
	98%
A4	100%
	Letter
	B5
	A5
	98%
B4	B5
	A4
A3	A4
SF	A4

3 Press Δ or ∇ to change to the Source Size required.

4 Press \triangleright to select Target Size / Reduction Ratio and move the position being entered.

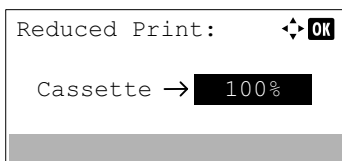

5 Press Δ or ∇ to change to the Target Size required. Only the Target Size / Reduction Ratio changes.

- Press **[OK]**. The Reduced Print is set and the Page Setting menu reappears.

Orientation (Print orientation)

You can select portrait (upright) or landscape (sideways) page orientation.

Portrait Orientation

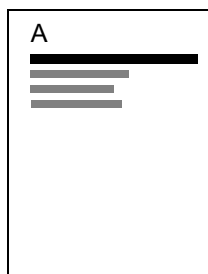

Landscape Orientation

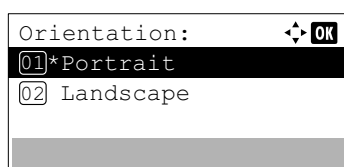

- In the Page Setting menu, press Δ or ∇ to select Orientation.
- Press **[OK]**. The Orientation screen appears.

- Press Δ or ∇ to select the desired Orientation.
- Press **[OK]**. The orientation is set and the Page Setting menu reappears.

LF Action (Linefeed)

This procedure instructs the printer what to do when it receives a linefeed code (0AH).

- LF Only: Linefeed is performed.
- LF and CR: A linefeed and carriage return are performed.
- Ignore LF: The linefeed is ignored.

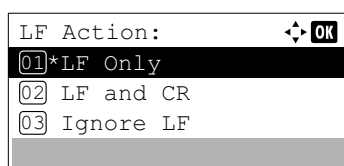

- In the Page Setting menu, press Δ or ∇ to select LF Action.
- Press **[OK]**. The LF Action screen appears.

- Press Δ or ∇ to select the desired action.
- Press **[OK]**. The action is set and the Page Setting menu reappears.

CR Action (Carriage-Return)

This procedure instructs the printer what to do when it receives a carriage return code (0DH).

- CR Only: A carriage-return is performed.
- LF and CR: A linefeed and carriage return are performed.
- Ignore CR: The carriage-return is ignored.

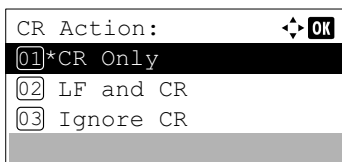

- 1 In the Page Setting menu, press Δ or ∇ to select CR Action.
- 2 Press [OK]. The CR Action screen appears.

- 3 Press Δ or ∇ to select the desired action.
- 4 Press [OK]. The action is set and the Page Setting menu reappears.

Wide A4 (Wide A4 pitch)

Turn this to On to increase the maximum number of characters that can be printed in a line for an A4 page (78 characters at 10 pitches) and Letter size page (80 characters at 10 pitches). This setting is only effective in PCL 6 emulation.

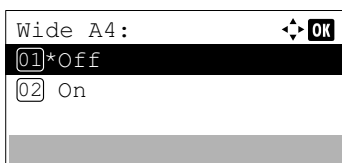

- 1 In the Page Setting menu, press Δ or ∇ to select Wide A4.
- 2 Press [OK]. The Wide A4 screen appears.

- 3 Press Δ or ∇ to select whether Wide A4 mode is enabled.
- 4 Press [OK]. The wide mode setting is set and the Page Setting menu reappears.

XPS FitTo Page (Adjusting the XPS file print out size)

Select On in this setting to enlarge or reduce XPS files to fit the printable area during printing.

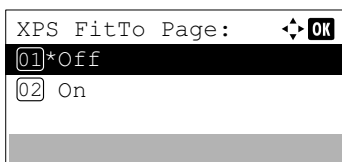

- 1 In the Page Setting menu, press Δ or ∇ to select XPS FitTo Page.
- 2 Press [OK]. The XPS FitTo Page screen appears.

- 3 Press Δ or ∇ to select whether XPS FitTo Page mode is enabled.
- 4 Press [OK]. The XPS FitTo Page setting is set and the Page Setting menu reappears.

TIFF/JPEG Size (Adjusting the TIFF/JPEG file print out size)

Use this setting to select the printing method used when TIFF or JPEG files are printed directly.

- 1 In the Page Setting menu, press Δ or ∇ to select TIFF/JPEG Size.

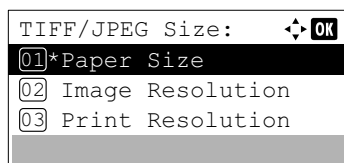

- 2 Press **[OK]**. The `TIFF/JPEG Size` screen appears.

The options available in `TIFF/JPEG Size` are as follows:

- `Paper Size`
Images are resized so that they fill the paper size when printed.
- `Image Resolution`
Image files are printed at the resolution specified in the resolution information. Images with no resolution information are printed using the `Paper Size` setting.
- `Print Resolution`
Images are printed using a 1-to-1 correspondence between the image file pixels and printed dots. For example, the printed size of a 600 × 300-pixel image file is 1 inch × 1/2 inch.

- 3 Press Δ or ∇ to select whether `TIFF/JPEG Size` mode is enabled.

- 4 Press **[OK]**. The `TIFF/JPEG Size` setting is set and the `Page Setting` menu reappears.



Note Images are automatically rotated during printing to provide a closer match between the aspect ratios of the image file and the paper used for printing.

User Name (The User Name display settings)

Set whether the user name set in the printer driver is displayed.

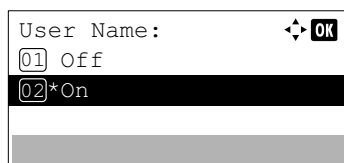

- 1 In the `Print Settings` menu, press Δ or ∇ to select `User Name`.

- 2 Press **[OK]**. The `User Name` screen appears.

- 3 Press Δ or ∇ to select `On` or `Off`.

- 4 Press **[OK]**. The `User Name` setting is set and the `Print Settings` menu reappears.

Job Name (The Job Name display settings)

Set whether the job name set in the printer driver is displayed.

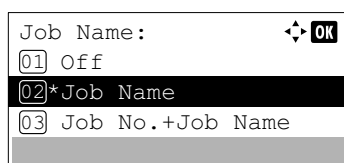

- 1 In the `Print Settings` menu, press Δ or ∇ to select `Job Name`.

- 2 Press **[OK]**. The `Job Name` screen appears.

The options available in `Job Name` are as follows:

- `Off`
- `Job Name (Use the job name set in the printer driver.)`
- `Job No. + Job Name`
- `Job Name + Job No.`

- 3 Press Δ or ∇ to select the desired job name.

- 4 Press **[OK]**. The `Job Name` setting is set and the `Print Settings` menu reappears.

Job Terminator (Job Terminator settings)

You can select the condition which regarded as a job termination if the print job could not be processed until the end due to your environment and the other reason. When selecting `EOJ`, the termination of the job data (R RES;!! EXIT;) is regarded as one job until it is detected. When selecting `End of Session`, the data included in a network session at network connection is regarded as one job. When selecting `UEL`, the UEL included in the termination of the job data is regarded as one job until it is detected.

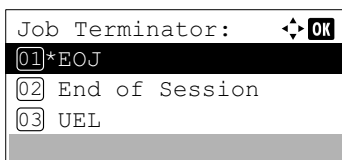

1 In the `Print Settings` menu, press Δ or ∇ to select `Job Terminator`.

2 Press **[OK]**. The `Job Terminator` screen appears.

3 Press Δ or ∇ to select `EOJ`, `End of Session` or `UEL`.

4 Press **[OK]**. The `Job Terminator` setting is set and the `Print Settings` menu screen reappears.

Network (Network settings)

Configure network settings.

The options available in the `Network` settings are as follows:

- `Host Name` (Check the host name of the machine)...4-61
- `Wi-Fi Direct Set` (`Wi-Fi Direct` settings)...4-61
- `Wi-Fi Settings` (`Wi-Fi Settings`)...4-63
- `Wired Netwk. Set` (`Wired Network Settings`)...4-70
- `ProtocolSettings` (Detailed settings for the network protocol)...4-78
- `Primary Network` (Select the network interface to use)...4-80
- `Ping` (Checking the connection of a connected device)...4-80
- `Restart Network` (Restarting the network card)...4-81

 **Note** Check with your network administrator when selecting the network setting. After all network related settings have been done, restart the network. Refer to *Restart Network (Restarting the network card)* on page 4-81. This is mandatory to make the settings effective!

When `Command Center RX` is used, network parameters and security settings can be conveniently changed and checked from your PC. For more information, refer to the *Command Center RX User Guide*.

1 Press **[Menu]**.

2 Press Δ or ∇ to select `Network`.

3 Press **[OK]**. The `Network` menu screen appears.

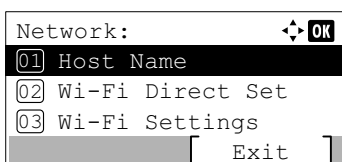

Host Name (Check the host name of the machine)

Check the host name of the machine. Host name can be changed from Command Center RX.

- 1 In the *Network* menu, press Δ or ∇ to select *Host Name*.
- 2 Press **[OK]**. The *Host Name* screen appears.

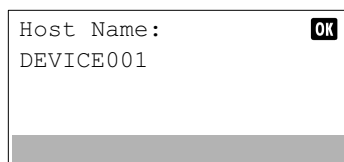

Wi-Fi Direct Set (Wi-Fi Direct settings)

Set Wi-Fi Direct.

 **Note** *Wi-Fi Direct Set* is only displayed when the optional Wireless Network Interface Kit (IB-36) is installed.

The options available in the *Wi-Fi Direct* settings are as follows:

- *Wi-Fi Direct (Enable/Disable Wi-Fi Direct)*...4-61
- *Device Name (Specify the device name.)*...4-62
- *IP address (Check the IP address of the machine.)*...4-62
- *Auto Disconnect (Auto Disconnect Settings)*...4-62
- *Disconnect Timer (Setting the Disconnect Time)*...4-63

- 1 In the *Network* menu, press Δ or ∇ to select *Wi-Fi Direct Set*.
- 2 Press **[OK]**. The *Wi-Fi Direct Set* menu screen appears.



Wi-Fi Direct (Enable/Disable Wi-Fi Direct)

This specified whether *Wi-Fi Direct* is used.

- 1 In the *Wi-Fi Direct Set* menu, press Δ or ∇ to select *Wi-Fi Direct*.
- 2 Press **[OK]**. The *Wi-Fi Direct* screen appears.

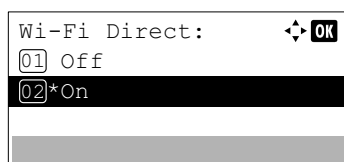

- 3 Press Δ or ∇ to select *On* or *Off*.
- 4 Press **[OK]**. The *Wi-Fi Direct* setting is set and the *Wi-Fi Direct Set* menu reappears.

Device Name (Specify the device name.)

Specify the device name.

 **Note** This setting is displayed when the setting for *Wi-Fi Direct (Enable/Disable Wi-Fi Direct)* on page 4-61 is set to On.

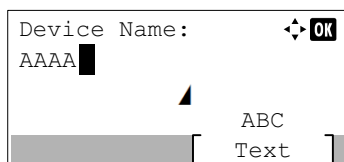

- 1 In the *Wi-Fi Direct Set* menu, press Δ or ∇ to select *Device Name*.
- 2 Press **[OK]**. The *Device Name* screen appears.

- 3 Enter the device name using the numeric keys.

 **Note** Up to 32 characters can be entered. For details on entering characters, refer to *Character Entry Method* on page A-2.

- 4 Press **[OK]**. The device name is stored and the *Wi-Fi Direct Set* menu reappears.

IP address (Check the IP address of the machine)

Check the IP address of the machine.

 **Note** This setting is displayed when the setting for *Wi-Fi Direct (Enable/Disable Wi-Fi Direct)* on page 4-61 is set to On.

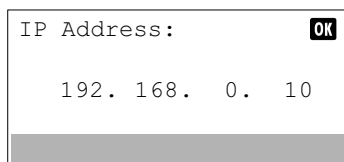

- 1 In the *Wi-Fi Direct Set* menu, press Δ or ∇ to select *IP address*.
- 2 Press **[OK]**. The *IP address* screen appears.

Auto Disconnect (Auto Disconnect Settings)

Automatically disconnect devices connected through Wi-Fi Direct.

 **Note** This setting is displayed when the setting for *Wi-Fi Direct (Enable/Disable Wi-Fi Direct)* on page 4-61 is set to On.

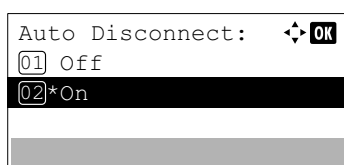

- 1 In the *Wi-Fi Direct Set* menu, press Δ or ∇ to select *Auto Disconnect*.
- 2 Press **[OK]**. The *Auto Disconnect* screen appears.

- 3 Press Δ or ∇ to select *On* or *Off*.
- 4 Press **[OK]**. The *Auto Disconnect* setting is set and the *Wi-Fi Direct Set* menu reappears.

Disconnect Timer (Setting the Disconnect Time)

You can set the time after which devices connected by Wi-Fi Direct are automatically disconnected.

 **Note** This setting is displayed when the setting for *Auto Disconnect (Auto Disconnect Settings)* on page 4-62 is set to On.

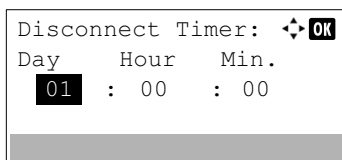

- 1 In the `Wi-Fi Direct Set` menu, press Δ or ∇ to select `Disconnect Timer`.
- 2 Press **[OK]**. The `Disconnect Timer` screen appears.

- 3 Press Δ or ∇ to set the day, hour, and minute. Use \triangleleft and \triangleright to move the cursor right and left.
- 4 Press **[OK]**. The disconnect time is set and the `Wi-Fi Direct Set` menu reappears.

Wi-Fi Settings (Wi-Fi Settings)

Set Wi-Fi.

 **Note** `Wi-Fi Settings` is only displayed when the optional Wireless Network Interface Kit (IB-36) is installed.

The options available in the Wi-Fi settings are as follows:

- `Wi-Fi (Enable/Disable Wi-Fi)`...4-63
- `Setup (Wireless network settings)`...4-64
- `TCP/IP Settings (TCP/IP Settings for the optional Network Interface Kit)`...4-89
- `Restart Network (Restarting the optional Network Interface Kit)`...4-70

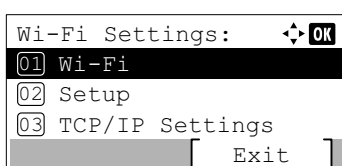

- 1 In the `Network` menu, press Δ or ∇ to select `Wi-Fi Settings`.
- 2 Press **[OK]**. The `Wi-Fi Settings` menu screen appears.

Wi-Fi (Enable/Disable Wi-Fi)

This specifies whether Wi-Fi is used.

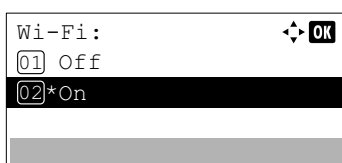

- 1 In the `Wi-Fi Settings` menu, press Δ or ∇ to select `Wi-Fi`.
- 2 Press **[OK]**. The `Wi-Fi` screen appears.

- 3 Press Δ or ∇ to select `On` or `Off`.
- 4 Press **[OK]**. The `Wi-Fi` setting is set and the `Wi-Fi Settings` menu reappears.

Setup (Wireless network settings)

This selects the settings for Wireless network.

 **Note** This setting is displayed when the setting for *Wi-Fi (Enable/Disable Wi-Fi)* on page 4-63 is set to On.

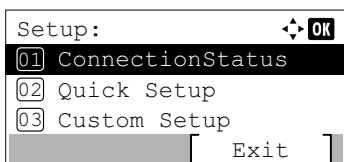

- 1 In the Wi-Fi Settings menu, press Δ or ∇ to select Setup.
- 2 Press [OK]. The Setup menu screen appears.

The options available in the Setup are as follows:

- ConnectionStatus (Wireless network connection status check)...4-64
- Quick Setup (Quick setup for the wireless network)...4-64
- Custom Setup (Detailed settings for the wireless network)...4-66

ConnectionStatus (Wireless network connection status check)

When the optional Wireless Network Interface Kit (IB-36) is installed, you can check the status of the wireless network.

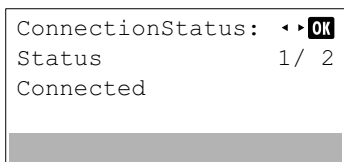

- 1 In the Setup menu, press Δ or ∇ to select ConnectionStatus.
- 2 Press [OK]. The ConnectionStatus screen appears.

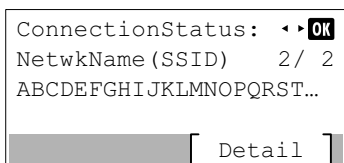

- 3 Press \triangleleft or \triangleright . The NetwkName (SSID) is displayed.

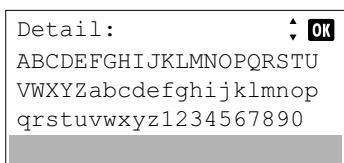

If the entire name shown as the NetwkName (SSID) will not fit on one line, pressing [Detail] ([Right Select]) changes to a 3-line name display.

Quick Setup (Quick setup for the wireless network)

When connecting to an access point which supports the automatic wireless network setup, you can select the connection settings using Quick Setup.

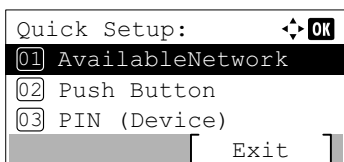

- 1 In the Setup menu, press Δ or ∇ to select Quick Setup.
- 2 Press [OK]. The Quick Setup menu screen appears.

The following operations are possible:

- AvailableNetwork (Display the access points)...4-65
- Push Button (Connect using Push Button)...4-65
- PIN (Device) (Connect using a PIN code (for the Wireless Network Interface Kit))...4-66

AvailableNetwork (Display the access points)

Displays the access points which can be connected to.

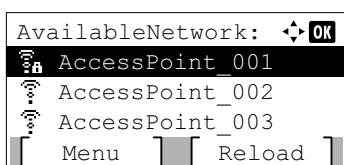

- 1 In the **Quick Setup** menu, press Δ or ∇ to **AvailableNetwork**.
- 2 Press **[OK]**. The **AvailableNetwork** screen appears.



Note If you cannot find the desired access point, press **[Reload]** (**[Right Select]**) to update the information.

Press **[Menu]** (**[Left Select]**) to display the next item.

- Detail (Detailed information of the selected access point appears.)
- WEP Key Index (Set the WEP key index.)

- 3 Press Δ or ∇ to select the access point to connect to.

- 4 Press **[OK]**. The connection with the access point is started.

When it is necessary to enter an encryption key, the **WEP Key** entry screen or **Preshared Key** entry screen appears.

When a WEP Key must be entered:

Enter the WEP Key using the numeric keys and press **[OK]**.



Up to 26 characters can be entered. For details on entering characters, refer to *Character Entry Method on page A-2*.

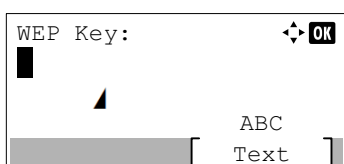

When a Preshared Key must be entered:

Enter the Preshared Key using the numeric keys and press **[OK]**.



Note The number of characters is between 8 and 64. For details on entering characters, refer to *Character Entry Method on page A-2*.

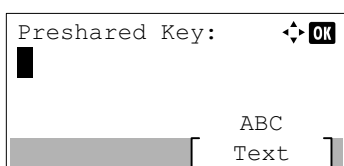

Push Button (Connect using Push Button)

When the access point supports the automatic wireless network setup button, you can configure the wireless settings automatically using the button and the panel operation of the printer.

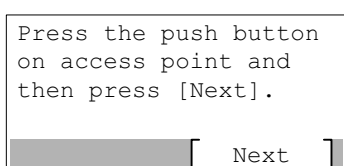

- 1 In the **Quick Setup** menu, press Δ or ∇ to select **Push Button**.
- 2 Press **[OK]**. A confirmation message is displayed.

- 3 Press the automatic wireless network setup button on the access point.

- 4 Press **[Next]** (**[Right Select]**). The message **Connecting...** appears and the connection with the access point starts.

PIN (Device) (Connect using a PIN code (for the Wireless Network Interface Kit))

The connection is started using the PIN code for the machine. The PIN code displayed should be entered at the access point. The PIN code for the machine is generated automatically.

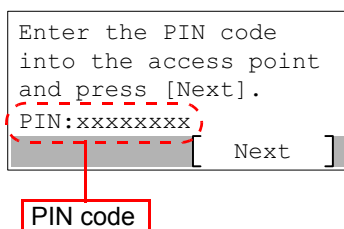
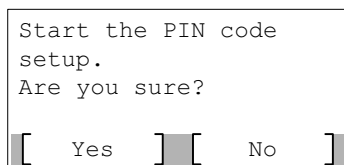

- 1 In the `Quick Setup` menu, press Δ or ∇ to select `PIN (Device)`.
- 2 Press **[OK]**. The message `Start the PIN code setup. Are you sure?` appears.
- 3 Press **[Yes]** (**[Left Select]**). A PIN code is displayed on the Message display.
- 4 Write down the PIN code displayed on the Message display.
- 5 Press **[Next]** (**[Right Select]**). The message `Connecting...` appears.
- 6 At the access point, immediately enter the PIN code which wrote down on step 4. The connection with the access point starts.

Custom Setup (Detailed settings for the wireless network)

It is possible to change the detailed settings of the wireless network.

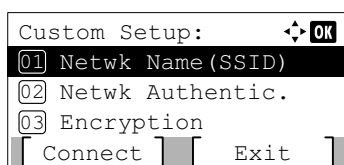

- 1 In the `Wireless Network` menu, press Δ or ∇ to select `Custom Setup`.
- 2 Press **[OK]**. The `Custom Setup` menu screen appears.
The following operations are possible:
 - `Netwk Name (SSID)` (Registration of the access point's SSID)...4-66
 - `Netwk Authentic.` (Network Authentication setting)...4-67
 - `Encryption` (Encryption settings)...4-67

Netwk Name (SSID) (Registration of the access point's SSID)

This sets the SSID (Service Set Identifier) for the wireless network access point the machine will be connected to.

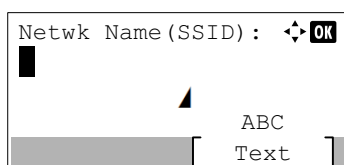

- 1 In the `Custom Setup` menu, press Δ or ∇ to select `Netwk Name (SSID)`.
- 2 Press **[OK]**. The `Netwk Name (SSID)` entry screen appears.
- 3 Enter the access point's SSID using the numeric keys.



Note Up to 32 characters can be entered. For details on entering characters, refer to *Character Entry Method* on page A-2.

- 4 Press **[OK]**. The `Custom Setup` menu reappears.

Netwk Authentic. (Network Authentication setting)

This sets the authentication method to be used when connecting to an access point.



Note You can also configure the network authentication setting for WPA-Enterprise and WPA2-Enterprise using the web page of the optional Wireless Network Interface Kit (IB-36). For details, refer to the *Command Center RX User Guide*.

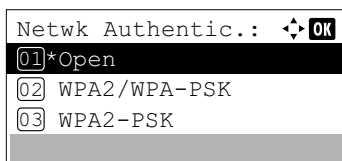

- 1 In the `Custom Setup` menu, press Δ or ∇ to select `Netwk Authentic..`

- 2 Press **[OK]**. The `Netwk Authentic.` screen appears.

The available authentication methods are as follows:

Open
WPA2/WPA-PSK
WPA2-PSK
WPA2/WPA-EAP
WPA2-EAP

- 3 Press Δ or ∇ to select the desired authentication method.

- 4 Press **[OK]**. The `Custom Setup` menu reappears.

Encryption (Encryption settings)

This selects the encryption settings.

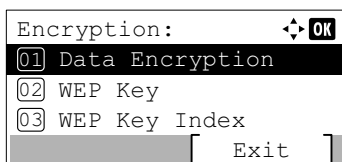

- 1 In the `Custom Setup` menu, press Δ or ∇ to select `Encryption.`

- 2 Press **[OK]**. The `Encryption` screen appears.

The following operations are possible:

- Data Encryption (Data Encryption setting)...4-67
- WEP Key (WEP Key settings)...4-68
- WEP Key Index (WEP Key Index Settings)...4-68
- Preshared Key (Preshared Key settings)...4-68



Note WEP Key and WEP Key Index is displayed when *Netwk Authentic. (Network Authentication setting)* on page 4-67 is set to Open.

Preshared Key is displayed when *Netwk Authentic. (Network Authentication setting)* on page 4-67 is set to WPA2/WPA-PSK or WPA2-PSK.

Data Encryption (Data Encryption setting)

This sets the encryption method.

- 1 In the `Encryption` menu, press Δ or ∇ to select `Data Encryption.`

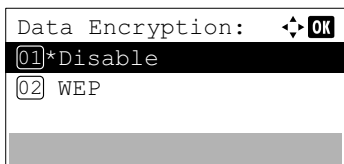

2 Press [OK]. The Data Encryption screen appears.



Note The encryption methods that can be selected vary depending on the authentication method set in *Netwk Authentic.* (*Network Authentication setting*) on page 4-67.

Disable or WEP can be selected when Open is set.

AES or Auto can be selected when WPA2/WPA-PSK, or WPA2-PSK is set.

AES can be selected when WPA2-PSK, or WPA2-EAP is set.

3 Press Δ or ∇ to select the desired encryption method.

4 Press [OK]. The Encryption menu reappears.

WEP Key (WEP Key settings)

This registers the WEP Key.

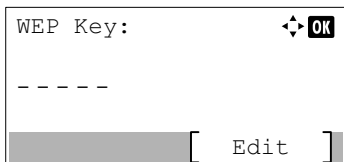

1 In the Encryption menu, press Δ or ∇ to select WEP Key.

2 Press [OK]. The WEP Key screen appears.

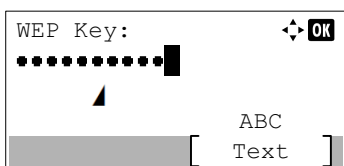

3 Press [Edit] ([Right Select]). The WEP Key entry screen appears.

4 Enter the WEP Key using the numeric keys.



Note Up to 26 characters can be entered. For details on entering characters, refer to *Character Entry Method* on page A-2.

5 Press [OK]. The Encryption menu reappears.

WEP Key Index (WEP Key Index Settings)

Select the key index of the access point.



1 In the Encryption menu, press Δ or ∇ to select WEP Key Index.

2 Press [OK]. The WEP Key Index screen appears.

3 Press Δ or ∇ to select the desired WEP Key Index.

4 Press [OK]. The Encryption menu reappears.

Preshared Key (Preshared Key settings)

This registers the Preshared Key.

1 In the Encryption menu, press Δ or ∇ to select Preshared Key.

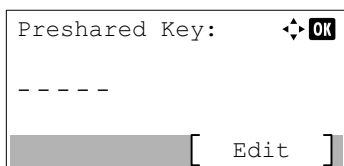

2 Press [OK]. The Preshared Key screen appears.

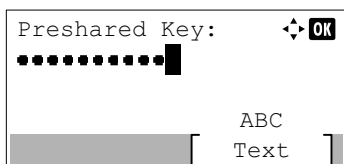

3 Press [Edit] ([Right Select]). The Preshared Key entry screen appears.

4 Enter the Preshared Key using the numeric keys.



Note The number of characters is between 8 and 64. For details on entering characters, refer to *Character Entry Method* on page A-2.

5 Press [OK] twice. The Encryption menu reappears.

TCP/IP Settings (TCP/IP Settings for the optional Network Interface Kit)

This selects the TCP/IP settings.

The options available in the TCP/IP Settings are as follows:

- TCP/IP (Enable/Disable TCP/IP)...4-89
- IPv4 Setting (TCP/IP IPv4 settings)...4-90
- IPv6 Setting (TCP/IP IPv6 settings)...4-90

1 In the Wi-Fi Settings menu, press Δ or ∇ to select TCP/IP Settings.

2 Press [OK]. The TCP/IP Settings menu screen appears.

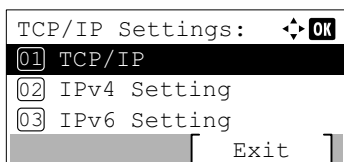

TCP/IP (Enable/Disable TCP/IP)

This specifies whether TCP/IP is used.

The method for setting is the same as for the standard Network settings. For details, refer to *TCP/IP (Enable/Disable TCP/IP)* on page 4-71.

IPv4 Setting (TCP/IP IPv4 settings)

This selects the settings for TCP/IP (IPv4). The method for setting is the same as for the standard Network settings. For details, refer to *IPv4 Setting (TCP/IP IPv4 settings)* on page 4-71.

IPv6 Setting (TCP/IP IPv6 settings)

This selects the settings for TCP/IP (IPv6). The method for setting is the same as for the standard Network settings. For details, refer to *IPv6 Setting (TCP/IP IPv6 settings)* on page 4-74.

Restart Network (Restarting the optional Network Interface Kit)

After all network related settings have been done, restart the network card of the device. This is mandatory to make the settings effective.

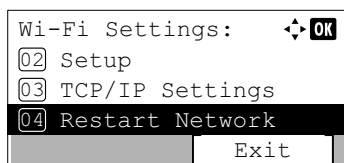

- 1 In the `Wi-Fi Settings` menu, press Δ or ∇ to select `Restart Network`.

- 2 Press **[OK]**. A confirmation screen appears.

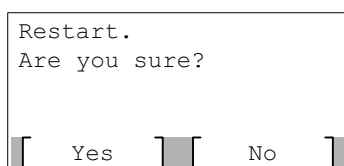

- 3 Press **[Yes]** (**[Left Select]**). The message `Restarting... Please wait.` appears and the network is restarted.

Pressing **[No]** (**[Right Select]**) returns to the `Basic` menu without restarting the network.

Wired Netwk. Set (Wired Network Settings)

Configure wired network settings.

The options available in the `Wired Network` are as follows:

- `TCP/IP Settings (TCP/IP Settings)`...4-70
- `LAN Interface (LAN Interface setting)`...4-77

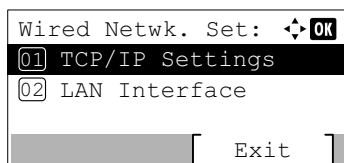

- 1 In the `Network` menu, press Δ or ∇ to select `Wired Netwk. Set`.

- 2 Press **[OK]**. The `Wired Netwk. Set` menu screen appears.

TCP/IP Settings (TCP/IP Settings)

This selects the `TCP/IP` settings.

The options available in the `TCP/IP Settings` are as follows:

- `TCP/IP (Enable/Disable TCP/IP)`...4-71
- `IPv4 Setting (TCP/IP IPv4 settings)`...4-71
- `IPv6 Setting (TCP/IP IPv6 settings)`...4-74

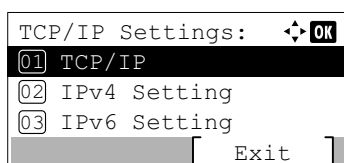

- 1 In the `Wired Netwk. Set` menu, press Δ or ∇ to select `TCP/IP Settings`.

- 2 Press **[OK]**. The `TCP/IP Settings` menu screen appears.

TCP/IP (Enable/Disable TCP/IP)

The TCP/IP system refers to the Internet system, which has a 5-layer structure consisting of the interface layer, link layer, network (IP) layer, transport (TCP/UDP) layer and application layer.

The interface layer is a key layer in the TCP/IP system that provides an abstracted interface that is not dependent on the link (communication line: frame relay or Ethernet, etc.) to the IP module (IP layer). This means that the IP module can use this abstracted interface (which is not dependent on the link type) to exchange IP packets back and forth with the link layer.

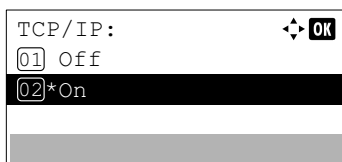

- 1 In the `TCP/IP Settings` menu, press Δ or ∇ to select `TCP/IP`.
- 2 Press **[OK]**. The `TCP/IP` screen appears.

- 3 Press Δ or ∇ to select whether TCP/IP is enabled.
- 4 Press **[OK]**. The TCP/IP setting is set and the `TCP/IP Settings` menu reappears.

IPv4 Setting (TCP/IP IPv4 settings)

This selects the settings for TCP/IP (IPv4).

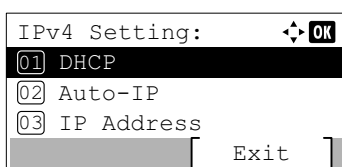

- 1 In the `TCP/IP Settings` menu, press Δ or ∇ to select `IPv4 Setting`.

- 2 Press **[OK]**. The `IPv4 Setting` menu screen appears.

The options available in the TCP/IP (IPv4) settings are as follows:

- DHCP (DHCP setting)...4-71
- Auto-IP (Auto-IP setting)...4-72
- IP Address (IP address setting)...4-72
- Subnet Mask (Subnet mask setting)...4-73
- Default Gateway (Gateway setting)...4-73

IMPORTANT The DHCP, Auto-IP, IP address, subnet mask, default gateway and Bonjour menu options for IPv4 settings are displayed when TCP/IP is enabled.

DHCP (DHCP setting)

DHCP (Dynamic Host Configuration Protocol) is the protocol that assigns the information required to establish a network connection when a host attempts to connect to the network (Internet). This information includes the IP address of the local node and the default router (the router in the host's own network system) and the DNS (Domain Name System) server. DHCP is an extension of the BOOTP (Bootstrap) startup protocol.

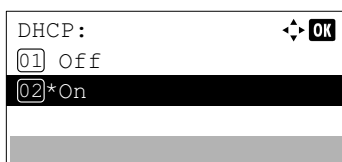

- 1 In the `IPv4 Setting` menu, press Δ or ∇ to select `DHCP`.

- 2 Press **[OK]**. The `DHCP` screen appears.

- 3 Press Δ or ∇ to select whether DHCP is enabled.

- 4 Press **[OK]**. The DHCP setting is set and the `IPv4 Setting` menu reappears.

Auto-IP (Auto-IP setting)

This protocol is used for automatic assignment of an IP address when you connect to a small network that does not have a DHCP server. Select an address from the range 169.254.0.1 to 169.254.255.254, and if no other device on the network is using that address, it is used as your address.

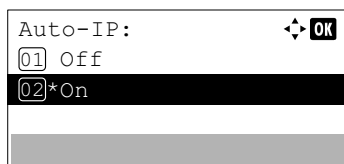

- 1 In the IPv4 Setting menu, press Δ or ∇ to select sAuto-IP.
- 2 Press [OK]. The Auto-IP screen appears.

- 3 Press Δ or ∇ to select whether Auto-IP is enabled.
- 4 Press [OK]. The Auto-IP setting is set and the IPv4 Setting menu reappears.

IP Address (IP address setting)

An IP address is the address of a network device such as a computer and is included in IP packets as needed for the sending and receiving of Internet data (IP packets). (IP addresses can be either destination addresses or source addresses.)

Specifically, an IP address is a bit string consisting of a host address (or host section) that identifies a computer (host) connected to the Internet and a network address (or network section) that identifies the network to which that computer belongs (or more specifically, the computer's network interface). Bit strings (IP addresses) that are unique throughout the entire Internet system are allocated to each computer or interface.

The IP addresses currently used on the Internet (IPv4) have a fixed length of 32 bits.

 **Note** When you enter the IP address, be sure to set the DHCP setting to Off.



- 1 In the IPv4 Setting menu, press Δ or ∇ to select IP Address.
- 2 Press [OK]. The IP Address screen appears.

- 3 Use the numeric keys or press Δ or ∇ to set the IP address.
You can set any value between 000 and 255.
Increase or reduce the figures by pressing Δ or ∇ .
Use \triangleleft and \triangleright to move the position being entered, which is shown highlighted.
- 4 Press [OK]. The IP address is stored and the IPv4 Setting menu reappears.

Subnet Mask (Subnet mask setting)

The subnet mask is a way of augmenting the network address section of an IP address.

A subnet mask represents all network address sections as 1 and all host address sections as 0. The number of bits in the prefix indicates the length of the network address. The term "prefix" refers to something added to the beginning and, in this context, indicates the first section of the IP address.

When an IP address is written, the length of the network address can be indicated by the prefix length after a forward slash (/). For example, "24" in the address "133.210.2.0/24". In this way, "133.210.2.0/24" denotes the IP address "133.210.2.0" with a 24-bit prefix (network section).

This new network address section (originally part of the host address) made possible by the subnet mask is referred to as the subnet address.



Note When you enter the subnet mask, be sure to set the DHCP setting to Off.

- 1 In the IPv4 Setting menu, press Δ or ∇ to select Subnet Mask.
- 2 Press [OK]. The Subnet Mask screen appears.
- 3 Use the numeric keys or press Δ or ∇ to set the subnet mask. You can set any value between 000 and 255. Increase or reduce the figures by pressing Δ or ∇ . Use \leftarrow and \rightarrow to move the position being entered, which is shown highlighted.
- 4 Press [OK]. The subnet mask setting is stored and the IPv4 Setting menu reappears.

Default Gateway (Gateway setting)

Gateway generally refers to a protocol conversion device used to allow networks with differing protocol systems to interconnect.

For example, a "Gateway" device is required to connect a different closed network (using its own protocols) to the open Internet (using TCP/IP).

By installing a gateway, the communications protocols and data display modes on different networks can be made compatible.

On TCP/IP networks, the term gateway is used to refer to routers.



Note Before you enter the gateway, be sure to set the DHCP setting to Off.

- 1 In the IPv4 Setting menu, press Δ or ∇ to select Default Gateway.
- 2 Press [OK]. The Default Gateway screen appears.

- 3 Use the numeric keys or press Δ or ∇ to set the default gateway. You can set any value between 000 and 255. Increase or reduce the figures by pressing Δ or ∇ . Use \triangleleft and \triangleright to move the position being entered, which is shown highlighted.
- 4 Press **[OK]**. The default gateway is stored and the IPv4 Setting menu reappears.

IPv6 Setting (TCP/IP IPv6 settings)

This selects the settings for TCP/IP (IPv6).

TCP/IP (IPv6) is based on the current Internet protocol, TCP/IP (IPv4). IPv6 is the next-generation Internet protocol and expands the available address space, which resolves the problem of the lack of addresses under IPv4, while also introducing other improvements such as additional security functionality and the capacity to prioritize data transmission.

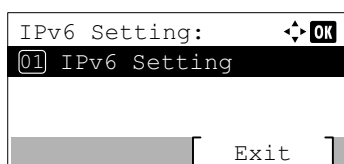

- 1 In the TCP/IP Settings menu, press Δ or ∇ to select IPv6 Setting.

- 2 Press **[OK]**. The IPv6 Setting menu screen appears.

The options available in the TCP/IP (IPv6) settings are as follows:

- TCP/IP (IPv6) (Enable/disable TCP/IP (IPv6))...4-74
- Link Local (Check the IP Address of the machine)...4-75
- Manual Settings (Manual Settings of TCP / IP (IPv6))...4-75
- RA (Stateless) (RA (Stateless) setting)...4-76
- DHCPv6 (DHCPv6 setting)...4-77

IMPORTANT The Link Local, Manual Settings, RA (Stateless) and DHCPv6 menu options for TCP/IP (IPv6) are displayed when TCP/IP (IPv6) is enabled.

TCP/IP (IPv6) (Enable/disable TCP/IP (IPv6))

This specified whether TCP/IP (IPv6) is used.

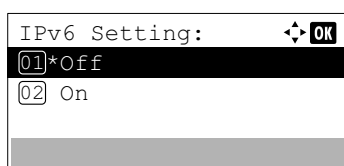

- 1 In the IPv6 Setting menu, press Δ or ∇ to select TCP/IP (IPv6).

- 2 Press **[OK]**. The TCP/IP (IPv6) screen appears.

- 3 Press Δ or ∇ to select whether TCP/IP (IPv6) is enabled.

- 4 Press **[OK]**. The TCP/IP (IPv6) setting is set and the IPv6 Setting menu reappears.

Link Local (Check the IP Address of the machine.)

Check the IP Address of the machine.

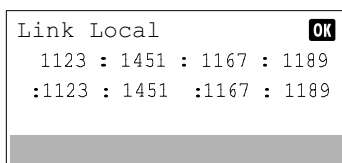

- 1 In the IPv6 Setting menu, press Δ or ∇ to select Link Local.
- 2 Press [OK]. The Link Local screen appears.

Manual Settings (Manual Settings of TCP / IP (IPv6))

Manually specify the IP address, prefix length, and gateway address of TCP/IP (IPv6).



- 1 In the IPv6 Setting menu, press Δ or ∇ to select Manual Settings.
- 2 Press [OK]. The Manual Settings menu screen appears.

The options available in the Manual Settings are as follows:

- IP Address (Setting the IP address)...4-75
- Prefix Length (Specify the prefix length)...4-75
- Default Gateway (Gateway setting)...4-76

IP Address (Setting the IP address)

Set the IP address of the TCP/IP (IPv6).

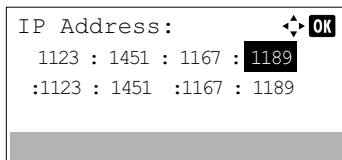

- 1 In the Manual Settings menu, press Δ or ∇ to select IP Address.
- 2 Press [OK]. The IP Address screen appears.
- 3 Use the numeric keys to set the IP address.
You can set any value between 0000 and FFFF.
Use \triangleleft and \triangleright to move the position being entered, which is shown highlighted.
- 4 Press [OK]. The IP address is stored and the Manual Settings menu reappears.

Prefix Length (Specify the prefix length)

Specify the prefix length of TCP/IP (IPv6).

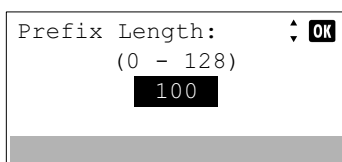

- 1 In the Manual Settings menu, press Δ or ∇ to select Prefix length.
- 2 Press [OK]. The Prefix length screen appears.

- 3 Use the numeric keys or press Δ or ∇ to set the prefix length.



Note You can set any value between 0 and 128.

- 4 Press [OK]. The prefix length is stored and the Manual Settings menu reappears.

Default Gateway (Gateway setting)

Specify the default gateway of TCP/IP (IPv6).

 **Note** Before you enter the gateway, be sure to set the RA (Stateless) setting to Off.

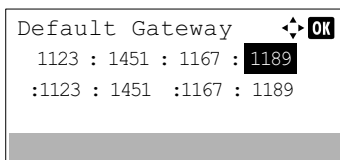

- 1 In the Manual Settings menu, press Δ or ∇ to select Default Gateway.
- 2 Press **[OK]**. The Default Gateway screen appears.
- 3 Use the numeric keys to set the default gateway.
You can set any value between 0000 and FFFF.
Use \triangleleft and \triangleright to move the position being entered, which is shown highlighted.
- 4 Press **[OK]**. The default gateway is stored and the Manual Settings menu reappears.

RA (Stateless) (RA (Stateless) setting)

The IPv6 router communicates (transmits) information such as the global address prefix using ICMPv6. This information is the Router Advertisement (RA).

ICMPv6 stands for Internet Control Message Protocol, and is an IPv6 standard defined in the RFC 2463 "Internet Control Message Protocol (ICMPv6) for the Internet Protocol Version 6 (IPv6) Specification".



- 1 In the IPv6 Setting menu, press Δ or ∇ to select RA (Stateless).
- 2 Press **[OK]**. The RA (Stateless) menu screen appears.
- 3 Press Δ or ∇ to select RA (Stateless).
- 4 Press **[OK]**. The RA (Stateless) screen appears.
- 5 Press Δ or ∇ to select whether RA (Stateless) is enabled.
- 6 Press **[OK]**. The RA (Stateless) setting is set and the IPv6 Setting menu reappears.

 **Note** When On is set, IP addresses are shown in "IP Address 1 (to 5)" after network restart.

DHCPv6 (DHCPv6 setting)

DHCPv6 is the next-generation of the Internet's Dynamic Host Configuration Protocol and supports IPv6. It extends the BOOTP startup protocol that defines the protocols used for transferring configuration information to hosts on the network.

DHCPv6 permits the DHCP server to use its expanded functionality to send configuration parameters to an IPv6 node. Because the network addresses that can be used are allocated automatically, the IPv6 node management workload is reduced in systems where the administrator has to exercise close control over IP address allocation.

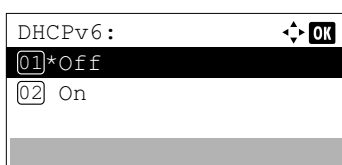
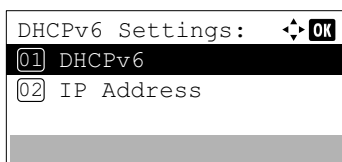

- 1 In the IPv6 Setting menu, press Δ or ∇ to select DHCPv6.
- 2 Press [OK]. The DHCPv6 menu screen appears.

- 3 Press Δ or ∇ to select DHCPv6.

- 4 Press [OK]. The DHCPv6 screen appears.

- 5 Press Δ or ∇ to select whether DHCPv6 is enabled.

- 6 Press [OK]. The DHCPv6 setting is set and the IPv6 Setting menu reappears.



Note When On is set, IP addresses are shown in "IP Address" after network restart.

LAN Interface (LAN Interface setting)

Specify the settings for the LAN interface to be used.

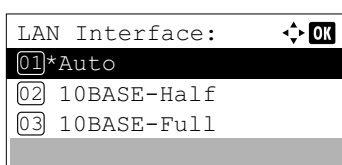

- 1 In the Wired Netwk. Set menu, press Δ or ∇ to select LAN Interface.

- 2 Press [OK]. The LAN Interface screen appears.

The available LAN Interface are as follows:

Auto
 10BASE-Half
 10BASE-Full
 100BASE-Half
 100BASE-Full
 1000BASE-T

- 3 Press Δ or ∇ to select the desired LAN Interface.

- 4 Press [OK]. The LAN Interface is set and the Wired Netwk. Set menu reappears.

ProtocolSettings (Detailed settings for the network protocol)

This selects the settings for Protocol Detail.

Item	Description	Restarting the System [†]
Bonjour ^{††}	Select whether to use Bonjour.	×
IPSec	Make this setting when you use IPSec.	×
NetBEUI ^{††}	Selects whether or not to receive documents using NetBEUI.	×
SNMPv3 ^{††}	Set SNMPv3.	●
FTP (Server) ^{††}	Select whether or not to receive documents using FTP.	●
SNMP ^{††}	Select whether or not to communicate using SNMP.	●
SMTP	Select whether or not to send e-mail using SMTP.	×
POP3	Select whether or not to receive e-mail using POP3.	×
RAW Port ^{††}	Select whether or not to communicate using RAW Port.	●
LPD ^{††}	Select whether or not to receive documents using LPD as the network protocol.	●
IPP ^{††}	Selects whether to receive documents using IPP. To use the IPP protocol, select <i>Not Secure (IPP&IPPS)</i> on IPP Security under Security Settings from the Command Center RX. The default port number is 631.	●
IPP Over SSL ^{††}	Select whether or not to use IPP over SSL.	●
HTTP ^{††}	Select whether or not to communicate using HTTP.	●
HTTPS ^{††}	Select whether to communicate using HTTPS.	●
LDAP	Select whether or not to use LDAP.	×
ThinPrint ^{††}	Select whether to use ThinPrint. To use the Thin Print protocol, set the protocol to <i>On</i> . The default port number is 4000. Also, to use the Thin Print over SSL protocol, set <i>Thin Print Over SSL</i> to <i>On</i> . Note This function is displayed only when the optional ThinPrint Option (UG-33) is activated.	●
WSD-PRINT ^{††}	Set whether to use our proprietary web services.	●
EnhancedWSD ^{††}	Set whether to use our proprietary web services.	●
Enhanced WSD(SSL) ^{††}	Set whether to use our proprietary web services over SSL.	●

[†] ●: The machine must be restarted after the setting is changed.

×: The machine does not need to be restarted after the setting is changed.

^{††} Set whether the setting is enabled on each network when the optional Wireless Network Interface Kit is installed.

Use the procedure below.

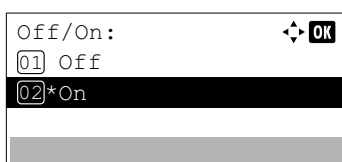
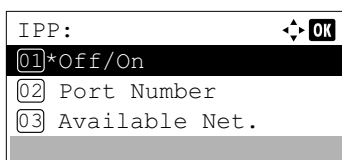
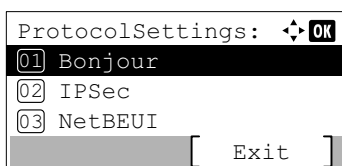

- 1 In the Network menu, press Δ or ∇ to select ProtocolSettings.
- 2 Press [OK]. The ProtocolSettings menu screen appears.

- 3 Press Δ or ∇ to select the item for which you want to make settings.
- 4 Press [OK]. This displays the setting screen for the item selected in step 3.

The screen shown is the one when IPP is selected.

- 5 Press Δ or ∇ to select Off/On.
- 6 Press [OK]. The Off/On screen appears.

- 7 Press Δ or ∇ to select On or Off.

- 8 Press [OK]. The IPP menu screen reappears.

Port Number (Port Number settings)

Specify the port number.

 **Note** This function appears when "IPP" or "ThinPrint" is selected in Protocol Settings (Detailed settings for the network protocol) on page 4-25.

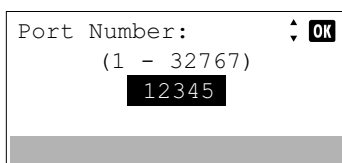

- 1 Press Δ or ∇ key in the menu screen of the selected item, and select the Port Number.
- 2 Press [OK]. The Port Number screen appears.

- 3 Use the numeric keys or press Δ or ∇ to set the Port Number.
- 4 Press [OK]. The Port Number is set and the menu screen of the selected item reappears.

Available Net. (Protocol settings of each network)

Set whether to enable this function for each network.

 **Note** This setting is only displayed when the optional Wireless Network Interface Kit is installed.

- 1 Press Δ or ∇ key in the menu screen of the selected item, and select the Available Net.

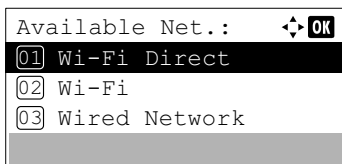

2 Press **[OK]**. The `Available Net.` menu screen appears.

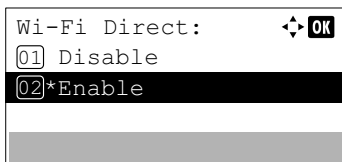

3 Press Δ or ∇ to select the item for which you want to make settings.

4 Press **[OK]**. This displays the setting screen for the item selected in step 3.

The screen shown is the one when `Wi-Fi Direct` is selected.

5 Press Δ or ∇ to select `Disable` or `Enable`.

6 Press **[OK]**. The `Available Net.` menu screen reappears.

Primary Network (Select the network interface to use)

Specify the network to be used for the send function, the network authentication.

 **Note** This setting is only displayed when the optional Network Interface Kit (IB-50) or Wireless Network Interface Kit (IB-51 or IB-36) is installed.

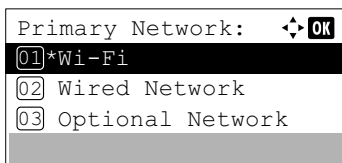

1 In the `Network` menu, press Δ or ∇ to select `Primary Network`.

2 Press **[OK]**. The `Primary Network` screen appears.

3 Press Δ or ∇ to select `Wi-Fi`, `Wired Network` or `Optional Network`.

 **Note** `Wi-Fi` is only displayed when the optional Wireless Network Interface Kit (IB-36) is installed.

`Optional Network` is only displayed when the optional Network Interface Kit (IB-50) or Wireless Network Interface Kit (IB-51) is installed.

4 Press **[OK]**. The `Primary Network` is set and the `Network` menu reappears.

Ping (Checking the connection of a connected device)

Checks if communication with the destination by entering the host name or IP address of the destination is possible.

 **Note** This setting is displayed when the setting for *Primary Network (Select the network interface to use)* on page 4-80 is set to other than `Optional Network`.

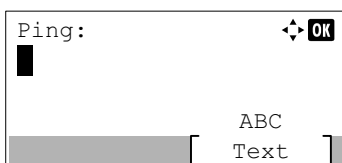

1 In the `Network` menu, press Δ or ∇ to select `Ping`.

2 Press **[OK]**. The `Ping` screen appears.

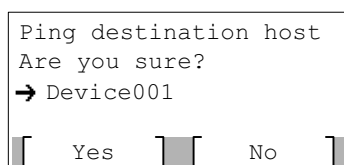

- 3 Use the numeric keys to enter the host name or IP address.



Note For details on entering characters, refer to *Character Entry Method* on page A-2.

- 4 Press **[OK]**. A confirmation screen appears.
- 5 Press **[Yes]** (**[Left Select]**). The message `Pinging destination host...` appears. Pressing **[No]** (**[Right Select]**) returns to the screen of step 3.
- 6 Press **[OK]**. The `Network` menu reappears.

Restart Network (Restarting the network card)

After all network related settings have been done, restart the network card of the device. This is mandatory to make the settings effective.

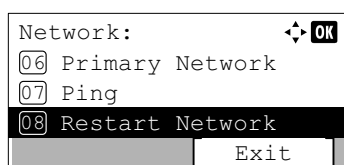

- 1 In the `Network` menu, press Δ or ∇ to select `Restart Network`.

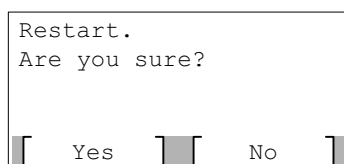

- 2 Press **[OK]**. A confirmation screen appears.
- 3 Press **[Yes]** (**[Left Select]**). The message `Restarting... Please wait.` appears and the network is restarted. Pressing **[No]** (**[Right Select]**) returns to the `Network` menu without restarting the network.

Optional Network (Optional Network settings)

This selects the settings for the optional Network Interface Kit (IB-50) or Wireless Network Interface Kit (IB-51).

 **Note** This is only displayed when a Network Interface Kit (IB-50) or Wireless Network Interface Kit (IB-51) is installed as an option.

The options available in the Optional Network settings are as follows:

- Wireless Network (Wireless network settings)...4-83
- Basic (Basic settings for the optional Network Interface Kit)...4-89

 **Note** Check with your network administrator when selecting the network setting. After all network related settings have been done, restart the network. Refer to *Restart Network (Restarting the optional Network Interface Kit)* on page 4-92. This is mandatory to make the settings effective!

When the web page for IB-50 or IB-51 is used, network parameters and security settings can be conveniently changed and checked from your PC. For more information, refer to the *IB-50/IB-51 User's Manual*.

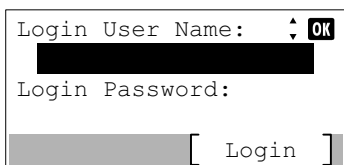

Login User Name: [redacted] OK

Login Password: [redacted]

[Login]

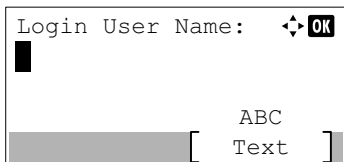

Login User Name: [] OK

ABC
Text

[]

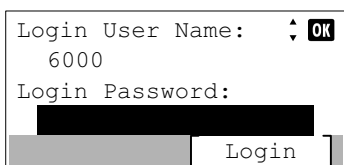

Login User Name: 6000 OK

Login Password: []

[Login]

- 1 Press **[Menu]**.
- 2 Press Δ or ∇ to select `Optional Network`.
- 3 Press **[OK]**. The Login screen appears.

 **Note** When user login administration is set:

- When logged in as an administrator, the log in screen is not displayed and the `Optional Network` menu screen is displayed.
- The setting is not possible when logged in as anyone other than an administrator. Log in again as an administrator.

- 4 With the `Login User Name` entry field selected, press **[OK]**. The `Login User Name` entry screen is displayed.

- 5 Enter the Login User Name using the numeric keys then press **[OK]**. The log in screen reappears.

 **Note** The initial setting for the administrator's Login User Name is set as shown below.

ECOSYS P3045dn: 4500

ECOSYS P3050dn: 5000

ECOSYS P3055dn: 5500

ECOSYS P3060dn: 6000

For details on entering characters, refer to *Character Entry Method* on page A-2.

- 6 Press Δ or ∇ to select the `Login Password` entry field.

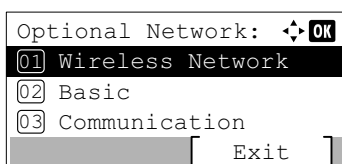
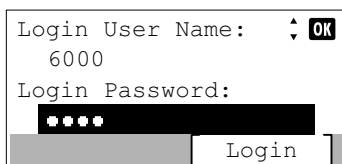
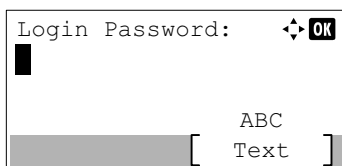

7 Press **[OK]**. The `Login Password` entry screen is displayed.

8 Enter the Login Password using the numeric keys then press **[OK]**. The login screen reappears.



Note The initial setting for the administrator's Login Password is set as shown below.

ECOSYS P3045dn: 4500

ECOSYS P3050dn: 5000

ECOSYS P3055dn: 5500

ECOSYS P3060dn: 6000

For details on entering characters, refer to *Character Entry Method* on page A-2.

9 Pressing `[Login]` (**[Right Select]**). If the entered Login User Name and Login Password are correct, the `Optional Network` menu appears showing a list of available options.

Wireless Network (Wireless network settings)

This selects the settings for Wireless network.



Note `Wireless Network` is only displayed when the optional Wireless Network Interface Kit (IB-51) is installed.

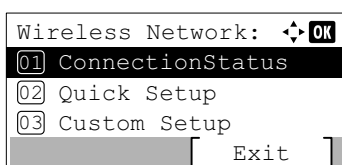

1 In the `Optional Network` menu, press Δ or ∇ to select `Wireless Network`.

2 Press **[OK]**. The `Wireless Network` menu screen appears.

The following operations are possible:

- `ConnectionStatus` (Wireless network connection status check)...4-83
- `Quick Setup` (Quick setup for the wireless network)...4-84
- `Custom Setup` (Detailed settings for the wireless network)...4-86

ConnectionStatus (Wireless network connection status check)

When the optional Wireless Network Interface Kit (IB-51) is installed, you can check the status of the wireless network.

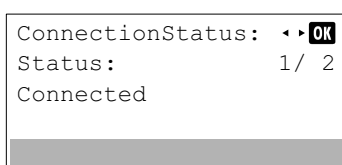

1 In the `Wireless Network` menu, press Δ or ∇ to select `ConnectionStatus`.

2 Press **[OK]**. The `ConnectionStatus` screen appears.

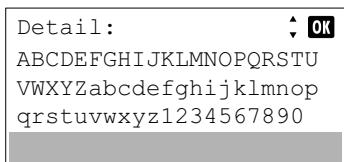
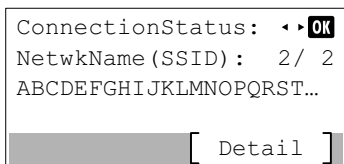

3 Press ◀ or ▶. The NetwkName (SSID) is displayed.

If the entire name shown as the NetwkName (SSID) will not fit on one line, pressing [Detail] ([Right Select]) changes to a 3-line name display.

Quick Setup (Quick setup for the wireless network)

When connecting to an access point which supports the automatic wireless network setup, you can select the connection settings using Quick Setup.

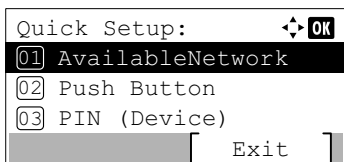

1 In the Wireless Network menu, press ▲ or ▼ to select Quick Setup.

2 Press [OK]. The Quick Setup menu screen appears.

The following operations are possible:

- AvailableNetwork (Display the access points)
- Push Button (Connect using Push Button)
- PIN (Device) (Connect using a PIN code (for the Wireless Network Interface Kit))
- PIN (Terminal) (Connect using a PIN code (for the access point))

AvailableNetwork (Display the access points)

Displays the access points which can be connected to.

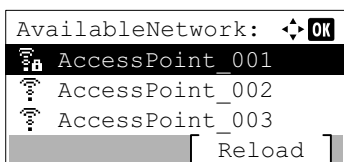

1 In the Quick Setup menu, press ▲ or ▼ to AvailableNetwork.

2 Press [OK]. The AvailableNetwork screen appears.

 **Note** If you cannot find the desired access point, press [Reload] ([Right Select]) to update the information.

3 Press ▲ or ▼ to select the access point to connect to.

4 Press [OK]. The connection with the access point is started.

When it is necessary to enter an encryption key, the WEP Key entry screen or Preshared Key entry screen appears.

When a WEP Key must be entered:

Enter the WEP Key using the numeric keys and press [OK].

 Up to 26 characters can be entered. For details on entering characters, refer to *Character Entry Method on page A-2*.

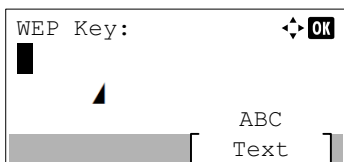

When a Preshared Key must be entered:

Enter the Preshared Key using the numeric keys and press [OK].

 **Note** The number of characters is between 8 and 64. For details on entering characters, refer to *Character Entry Method on page A-2*.

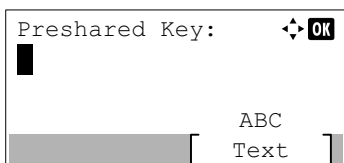

Push Button (Connect using Push Button)

When the access point supports the automatic wireless network setup button, you can configure the wireless settings automatically using the button and the panel operation of the printer.

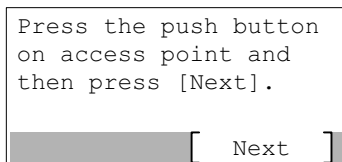

- 1 In the `Quick Setup` menu, press Δ or ∇ to select `Push Button`.
- 2 Press **[OK]**. A confirmation message is displayed.
- 3 Press the automatic wireless network setup button on the access point.
- 4 Press `[Next]` (**[Right Select]**). The message `Connecting...` appears and the connection with the access point starts.

PIN (Device) (Connect using a PIN code (for the Wireless Network Interface Kit))

The connection is started using the PIN code for the machine. The PIN code displayed should be entered at the access point. The PIN code for the machine is generated automatically.

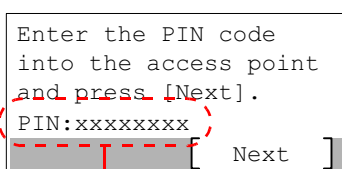

PIN code

- 1 In the `Quick Setup` menu, press Δ or ∇ to select `PIN (Device)`.
- 2 Press **[OK]**. A PIN code is displayed on the Message display.
- 3 Write down the PIN code displayed on the Message display.
- 4 Press `[Next]` (**[Right Select]**). The message `Connecting...` appears.
- 5 At the access point, immediately enter the PIN code which wrote down on step 3. The connection with the access point starts.

PIN (Terminal) (Connect using a PIN code (for the access point))

The connection is started using the PIN code for the access point. Enter the PIN code for the access point. For details of the PIN code for the access point, refer to the Operation Guide of the access point.



- 1 In the `Quick Setup` menu, press Δ or ∇ to select `PIN (Terminal)`.
- 2 Press **[OK]**. The `PIN code` entry screen appears.
- 3 Enter the PIN Code using the numeric keys.

 **Note** Up to 8 characters can be entered. For details on entering characters, refer to *Character Entry Method* on page A-2.
- 4 Press **[OK]**. The message `Connecting...` appears and the connection with the access point starts.

Custom Setup (Detailed settings for the wireless network)

It is possible to change the detailed settings of the wireless network.

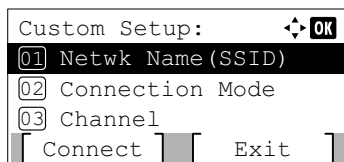

1 In the `Wireless Network` menu, press Δ or ∇ to select `Custom Setup`.

2 Press **[OK]**. The `Custom Setup` menu screen appears.

The following operations are possible:

- `Netwk Name (SSID)` (Registration of the access point's SSID)
- `Connection Mode` (Switch between connection modes)
- `Channel` (Channel settings)
- `Netwk Authentic.` (Network Authentication setting)
- `Encryption` (Encryption settings)

Netwk Name (SSID) (Registration of the access point's SSID)

This sets the SSID (Service Set Identifier) for the wireless network access point the machine will be connected to.

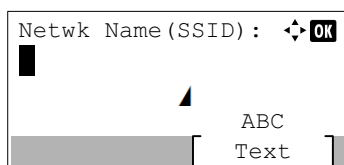

1 In the `Custom Setup` menu, press Δ or ∇ to select `Netwk Name (SSID)`.

2 Press **[OK]**. The `Netwk Name (SSID)` entry screen appears.

3 Enter the access point's SSID using the numeric keys.

 **Note** Up to 32 characters can be entered. For details on entering characters, refer to *Character Entry Method* on page A-2.

4 Press **[OK]**. The `Custom Setup` menu reappears.

Connection Mode (Switch between connection modes)

This selects the method for connecting to the wireless network. Set `Ad Hoc` when machines will be connected directly with each other, without going through an access point.

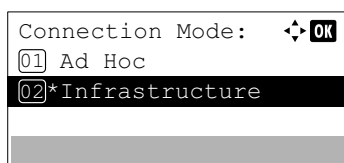

1 In the `Custom Setup` menu, press Δ or ∇ to select `Connection Mode`.

2 Press **[OK]**. The `Connection Mode` screen appears.

The available `Connection Mode` are as follows:

- `Ad Hoc` (Connect without going through access points)
- `Infrastructure` (Connect via an access point)

3 Press Δ or ∇ to select the connection mode.

4 Press **[OK]**. The `Custom Setup` menu reappears.

Channel (Channel settings)

This sets the Channel to be used in the wireless network.

1 In the `Custom Setup` menu, press Δ or ∇ to select `Channel`.

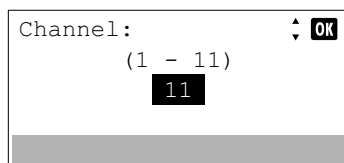

2 Press **[OK]**. The Channel screen appears.

3 Enter the Channel number using the numeric keys, Δ or ∇ .



Note The Channel can be set between 1 and 11.

4 Press **[OK]**. The Custom Setup menu reappears.

Netwk Authentic. (Network Authentication setting)

This sets the authentication method to be used when connecting to an access point.



Note You can also configure the network authentication setting for WPA-Enterprise and WPA2-Enterprise using the web page of the optional Wireless Network Interface Kit (IB-51). For details, refer to the *IB-51 User's Manual*.

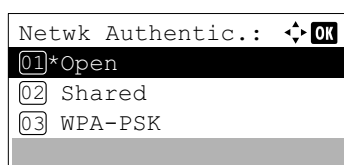

1 In the Custom Setup menu, press Δ or ∇ to select Netwk Authentic..

2 Press **[OK]**. The Netwk Authentic. screen appears.

The available authentication methods are as follows:

Open

Shared

WPA-PSK

WPA2-PSK



Note WPA-PSK and WPA2-PSK are only displayed when Infrastructure has been set as the Connection Mode (Switch between connection modes) on page 4-86.

3 Press Δ or ∇ to select the desired authentication method.

4 Press **[OK]**. The Custom Setup menu reappears.

Encryption (Encryption settings)

This selects the encryption settings.



Note This setting is not displayed when the setting for Netwk Authentic. (Network Authentication setting) on page 4-87 is set to use an authentication method other than Open, Shared, WPA-PSK and WPA2-PSK, using Utility.

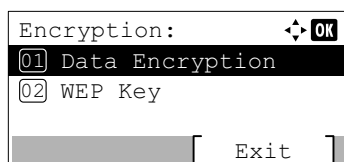

1 In the Custom Setup menu, press Δ or ∇ to select Encryption.

2 Press **[OK]**. The Encryption screen appears.

The following operations are possible:

- Data Encryption (Data Encryption setting)...4-88

- WEP Key (WEP Key settings)...4-88

- Preshared Key (Preshared Key settings)...4-88



Note WEP Key is displayed when Netwk Authentic. (Network Authentication setting) on page 4-87 is set to Open or Shared.

Preshared Key is displayed when Netwk Authentic. (Network Authentication setting) on page 4-87 is set to WPA-PSK or WPA2-PSK.

Data Encryption (Data Encryption setting)

This sets the encryption method.



- 1 In the Encryption menu, press Δ or ∇ to select Data Encryption.
- 2 Press [OK]. The Data Encryption screen appears.



Note The encryption methods that can be selected vary depending on the authentication method set in *Netwk Authentic.* (*Network Authentication setting*) on page 4-87.

Disable or WEP can be selected when Open or Shared is set.

TKIP, AES or Auto can be selected when WPA-PSK is set.

AES can be selected when WPA2-PSK is set.

- 3 Press Δ or ∇ to select the desired encryption method.
- 4 Press [OK]. The Encryption menu reappears.

WEP Key (WEP Key settings)

This registers the WEP Key.

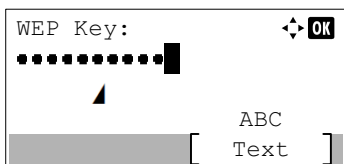
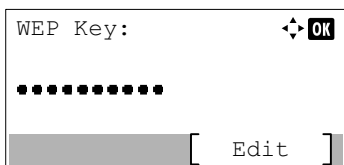

- 1 In the Encryption menu, press Δ or ∇ to select WEP Key.
- 2 Press [OK]. The WEP Key screen appears.
- 3 Press [Edit] ([Right Select]). The WEP Key entry screen appears.

- 4 Enter the WEP Key using the numeric keys.



Note Up to 26 characters can be entered. For details on entering characters, refer to *Character Entry Method* on page A-2.

- 5 Press [OK]. The Encryption menu reappears.

Preshared Key (Preshared Key settings)

This registers the Preshared Key.

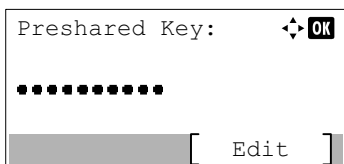

- 1 In the Encryption menu, press Δ or ∇ to select Preshared Key.
- 2 Press [OK]. The Preshared Key screen appears.

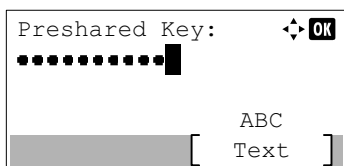

3 Press [Edit] ([Right Select]). The Preshared Key entry screen appears.

4 Enter the Preshared Key using the numeric keys.



Note The number of characters is between 8 and 64. For details on entering characters, refer to *Character Entry Method* on page A-2.

5 Press [OK]. The Encryption menu reappears.

Basic (Basic settings for the optional Network Interface Kit)

This selects the basic settings for the optional Network Interface Kit (IB-50) or optional Wireless Network Interface Kit (IB-51) network.

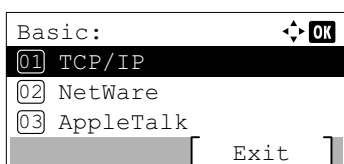

1 In the Optional Network menu, press Δ or ∇ to select Basic.

2 Press [OK]. The Basic menu screen appears.

The following operations are possible:

- TCP/IP Settings (TCP/IP Settings for the optional Network Interface Kit)...4-89
- Netware (NetWare setting)...4-90
- AppleTalk (AppleTalk setting)...4-90
- IPSec (IPSec setting)...4-91
- LAN Interface (LAN Interface setting)...4-91
- MACAddressFilter (MAC address filtering setting)...4-91
- Restart Network (Restarting the optional Network Interface Kit)...4-92

TCP/IP Settings (TCP/IP Settings for the optional Network Interface Kit)

This selects the TCP/IP settings.

The options available in the TCP/IP Settings are as follows:

- TCP/IP (Enable/Disable TCP/IP)
- IPv4 Setting (TCP/IP IPv4 settings)
- IPv6 Setting (TCP/IP IPv6 settings)

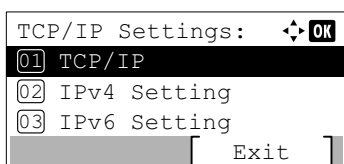

1 In the Basic menu, press Δ or ∇ to select TCP/IP Settings.

2 Press [OK]. The TCP/IP Settings menu screen appears.

TCP/IP (Enable/Disable TCP/IP)

This specified whether TCP/IP is used.

The method for setting is the same as for the standard Network settings. For details, refer to *TCP/IP (Enable/Disable TCP/IP)* on page 4-71.

IPv4 Setting (TCP/IP IPv4 settings)

This selects the settings for TCP/IP (IPv4). The method for setting is the same as for the standard Network settings. For details, refer to *IPv4 Setting (TCP/IP IPv4 settings) on page 4-71*.

IPv6 Setting (TCP/IP IPv6 settings)

This selects the settings for TCP/IP (IPv6). The method for setting is the same as for the standard Network settings. For details, refer to *IPv6 Setting (TCP/IP IPv6 settings) on page 4-74*.

NetWare (NetWare setting)

NetWare is a PC-based network operating system specifically for servers. NetWare is a client-server system that operates by installing the NetWare OS on the server and dedicated client modules (NetWare clients) on the client machines (running MS-DOS, OS/2, Windows, etc.). The basic network layer protocol used is NetWare's own IPX (Internetwork Packet eXchange)/SPX (Sequenced Packet eXchange), but the system also supports TCP/IP.

The feature of the NetWare OS is that it is specifically for servers, unlike general-purpose operating systems such as Windows NT and UNIX. Only the minimum required for server operation can be performed from the NetWare OS console on the server. Server and file management is basically carried out using management tools from the clients. Also, all drivers and protocol stacks are in the form of modules called NetWare Loadable Modules (NLMs), and the ability of NLMs to load and unload flexibly and dynamically is a major advantage of this system.

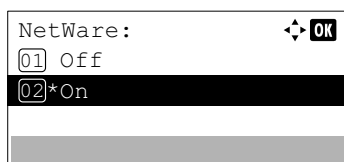

- 1** In the `Basic` menu, press Δ or ∇ to select `NetWare`.
- 2** Press **[OK]**. The `Netware` screen appears.
- 3** Press Δ or ∇ to select whether `NetWare` is enabled.
- 4** Press **[OK]**. The `NetWare` setting is set and the `Basic` menu reappears.

AppleTalk (AppleTalk setting)

AppleTalk is a communications protocol used primarily on Macintosh computers and also refers to the Mac OS network functions.

AppleTalk assigns 24-bit network addresses (a 16-bit network section and an 8-bit node address) that are used to identify devices (computers, printers, etc.) on the network.

When the power is turned on, a broadcast signal is sent out onto the network and the addresses and machine names are automatically assigned.

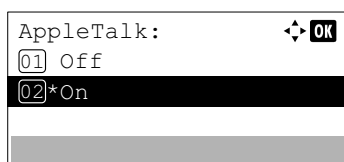

- 1** In the `Basic` menu, press Δ or ∇ to select `AppleTalk`.
- 2** Press **[OK]**. The `AppleTalk` screen appears.
- 3** Press Δ or ∇ to select whether `AppleTalk` is enabled.
- 4** Press **[OK]**. The `AppleTalk` setting is set and the `Basic` menu reappears.

IPSec (IPSec setting)

IPSec (IP Security Protocol) is a security protocol adopted as the standard by the IETF for authentication and encryption in the third network layer (IP layer).

It can be used with both IPv4 and IPv6.

 **Note** IPv4 uses 32-bit IP addresses and IPv6 uses 128-bit IP addresses.

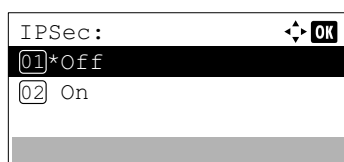

- 1 In the `Basic` menu, press Δ or ∇ to select `IPSec`.
- 2 Press **[OK]**. The `IPSec` screen appears.

- 3 Press Δ or ∇ to select whether IPSec is enabled.
- 4 Press **[OK]**. The IPSec setting is set and the `Basic` menu reappears.

LAN Interface (LAN Interface setting)

Specify the settings for the LAN interface to be used. The default setting is `Auto`.

 **Note** `LAN Interface` is only displayed when the optional Network Interface Kit (IB-50) is installed.

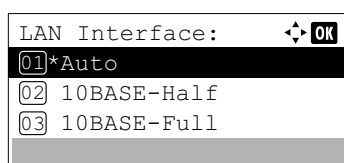

- 1 In the `Basic` menu, press Δ or ∇ to select `LAN Interface`.
- 2 Press **[OK]**. The `LAN Interface` screen appears.

The available LAN Interface are as follows:

Auto
 10BASE-Half
 10BASE-Full
 100BASE-Half
 100BASE-Full
 1000BASE-T

- 3 Press Δ or ∇ to select the desired LAN Interface.
- 4 Press **[OK]**. The LAN Interface is set and the `Basic` menu reappears.

MACAddressFilter (MAC address filtering setting)

This sets whether or not to enable MAC address filtering.

 **Note** The detailed settings for MAC address filtering are selected using the optional Network Interface Kit utility software.



- 1 In the `Basic` menu, press Δ or ∇ to select `MACAddressFilter`.
- 2 Press **[OK]**. The `MACAddressFilter` screen appears.

- 3 Press Δ or ∇ to select whether MAC address filtering is enabled.

- 4 Press **[OK]**. The MAC address filtering setting is set and the `Basic` menu reappears.

Restart Network (Restarting the optional Network Interface Kit)

After all network related settings have been done, restart the network card of the device. This is mandatory to make the settings effective.

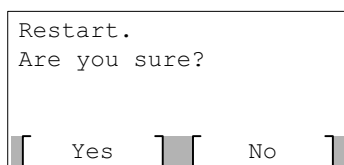

- 1 In the `Basic` menu, press Δ or ∇ to select `Restart Network`.
- 2 Press **[OK]**. A confirmation screen appears.
- 3 Press `[Yes]` (**[Left Select]**). The message `Restarting... Please wait.` appears and the network is restarted. Pressing `[No]` (**[Right Select]**) returns to the `Basic` menu without restarting the network.

Device Common (Selecting/Setting the common device)

Selects/sets all the functions in this printer.

The options available in Device Common are as follows:

- Language (Selecting the message language)...4-93
- Def. Screen(Box) (Document Box default screen setting)...4-94
- Date Setting (Date and time settings)...4-95
- Buzzer (Alarm (Buzzer) setting)...4-98
- RAM Disk Setting (Using the RAM disk)...4-100
- Format SSD (Formatting the SSD)...4-101
- Format SD Card (Formatting the SD card)...4-102
- Display Bright. (Display brightness setting)...4-102
- Disp. Backlight (Display backlight setting)...4-103
- Error Handling (Error detection setting)...4-103
- Timer Setting...4-105
- Disp. Status/Log (Display Status/Log setting)...4-117
- USB KeyboardType (USB keyboard type selection)...4-118
- Low Toner Alert (Setting for the alert level for toner addition)...4-119
- Msg Banner Print (Check setting before banner printing)...4-120

IMPORTANT Def. Screen(Box), Format SSD and Format SD Card only appear when the relevant option is installed.

- 1** Press **[Menu]**.
- 2** Press Δ or ∇ to select Device Common.
- 3** Press **[OK]**. The Device Common menu appears showing a list of available options.

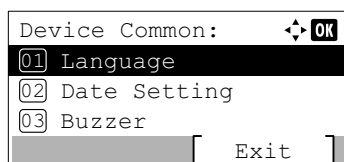

Language (Selecting the message language)

You can select the language of the message display by following the procedure given below. You can optionally download messages in other languages. Contact your service technician for information.

- 1** In the Device Common menu, press Δ or ∇ to select Language.
- 2** Press **[OK]**. The Language screen appears showing the list of languages.

The available languages are as follows:

English
 Deutsch
 Français
 Español
 Italiano
 Nederlands
 Русский
 日本語
 Português

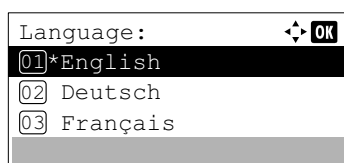

The optional languages are as follows:

Optional language	Message display
Turkish	Türkçe
Greek	Ελληνικά
Polish	Polski
Czech	Česky
Hungarian	Magyar
Finnish	Suomi
Hebrew	אנגלית
Arabic	أريبيك
Swedish	Svenska
Danish	Dansk
Norwegian	Norsk
Romanian	Român

If you are using one of the optional languages, it is displayed in place of Português.



Note To add an optional language, contact your service representative or authorized service center.

- 3** Press Δ or ∇ to select the desired language.
- 4** Press **[OK]**. The language is set and the `Device Common` menu reappears.

Def. Screen(Box) (Document Box default screen setting)

Select the screen to be displayed when **[Document Box]** is pressed.

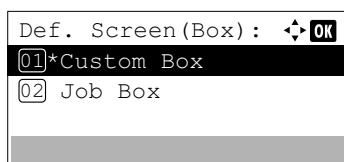

- 1** In the `Device Common` menu screen, press Δ or ∇ to select `Def. Screen (Box)`.
- 2** Press **[OK]**. The `Def. Screen (Box)` screen appears.
- 3** Press Δ or ∇ to select either `Custom BOX` or `Job BOX` as the default screen.
- 4** Press **[OK]**. The default screen is set and the `Device Common` menu reappears.

Date Setting (Date and time settings)

Set the date and time.

IMPORTANT To change the Date Setting, the administrator's Login User Name and Login Password must be entered. For details of the administrator settings, refer to *Administrator* on page 4-136.

If you change the date/time while using an application, you will no longer be able to use the application.

The date and time settings consist of the following items:

- Date (date setting)...4-96
- Time (time setting)...4-96
- Date Format (date format selection)...4-97
- Time Zone (time difference setting)...4-97
- Summer Time (summer time setting)...4-97

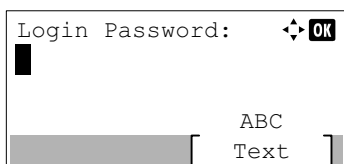
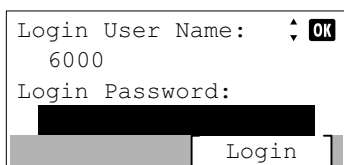
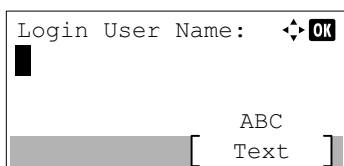
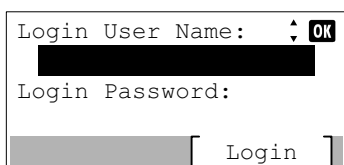

- 1 In the Device Common menu, press Δ or ∇ to select Date Setting.
- 2 Press [OK]. The Login screen appears.
 - Note** When user login administration is set:
 - When logged in as an administrator, the log in screen is not displayed and the Date Setting menu screen is displayed.
 - The setting is not possible when logged in as anyone other than an administrator. Log in again as an administrator.
- 3 With the Login User Name entry field selected, press [OK]. The Login User Name entry screen is displayed.
- 4 Enter the Login User Name using the numeric keys then press [OK]. The log in screen reappears.
 - Note** The initial setting for the administrator's Login User Name is set as shown below.
 - ECOSYS P3045dn: 4500
 - ECOSYS P3050dn: 5000
 - ECOSYS P3055dn: 5500
 - ECOSYS P3060dn: 6000
 For details on entering characters, refer to *Character Entry Method* on page A-2.
- 5 Press Δ or ∇ to select the Login Password entry field.
- 6 Press [OK]. The Login Password entry screen is displayed.

- Enter the Login Password using the numeric keys then press **[OK]**. The login screen reappears.



Note The initial setting for the administrator's Login User Password is set as shown below.

ECOSYS P3045dn: 4500

ECOSYS P3050dn: 5000

ECOSYS P3055dn: 5500

ECOSYS P3060dn: 6000

For details on entering characters, refer to *Character Entry Method* on page A-2.

- Pressing **[Login]** (**[Right Select]**). If the entered Login User Name and Login Password are correct, the Date Setting menu appears showing a list of available options.

Date (date setting)

- In the Date Setting menu, press Δ or ∇ to select Date.
- Press **[OK]**. The Date screen appears.

- Use the numeric keys or press Δ or ∇ to set the year, month, and day.
Use \triangleleft and \triangleright to move the cursor right and left.
- Press **[OK]**. The date is set and the Date Setting menu reappears.

Time (time setting)

- In the Date Setting menu, press Δ or ∇ to select Time.
- Press **[OK]**. The Time screen appears.

- Use the numeric keys or Δ or ∇ to set the hour, minute, and second.
Use \triangleleft and \triangleright to move the cursor right and left.
- Press **[OK]**. The time is set and the Date Setting menu reappears.

Date Format (date format selection)

One of three formats can be selected for the date format.

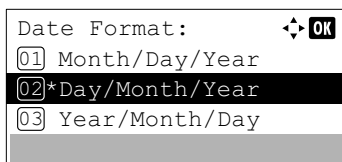

- 1 In the Date Setting menu, press Δ or ∇ to select Date Format.
- 2 Press [OK]. The Date Format screen appears.

- 3 Press Δ or ∇ to select the desired date format.

The following date formats can be selected:

Month/Day/Year

Day/Month/Year

Year/Month/Day

- 4 Press [OK]. The date format is set and the Date Setting menu reappears.

Time Zone (time difference setting)

Set the time difference from GMT.

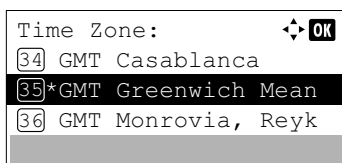

- 1 In the Date Setting menu, press Δ or ∇ to select Time Zone.
- 2 Press [OK]. The Time Zone screen appears.

- 3 Press Δ or ∇ to select the location.

- 4 Press [OK]. The time zone is set and the Date Setting menu reappears.

 **Note** If you select a region that does not utilize summer time, the summer time setting will not appear.

Summer Time (summer time setting)

Set summer time.

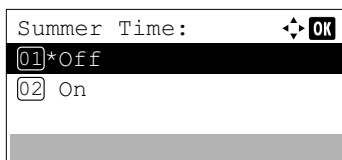

- 1 In the Date Setting menu, press Δ or ∇ to select Summer Time.
- 2 Press [OK]. The Summer Time screen appears.

- 3 Press Δ or ∇ to select whether the summer time is enabled.

- 4 Press [OK]. The summer time is set and the Date Setting menu reappears.

Buzzer (Alarm (Buzzer) setting)

This function uses tones to notify the user of printer operations and the printer status. This setting is useful, for example, when the printer is located some distance from the user.

The options available in Buzzer are as follows:

- Key Confirmation (Key confirmation tone setting)...4-98
- Job Finish (Job completed tone setting)...4-98
- Ready (Preparation completed tone setting)...4-99
- Error (Error tone setting)...4-99
- Keyboard Confirm (Keyboard confirmation tone setting)...4-99

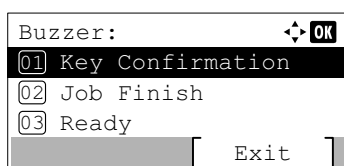

- 1 In the `Device Common` menu, press Δ or ∇ to select `Buzzer`.
- 2 Press **[OK]**. The `Buzzer` screen appears.

Key Confirmation (Key confirmation tone setting)

When `On` is selected in this setting, a tone sounds each time a key is used.

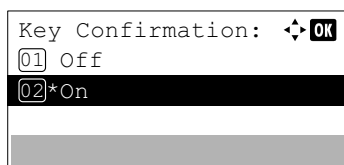

- 1 In the `Buzzer` menu screen, press Δ or ∇ to select `Key Confirmation`.
- 2 Press **[OK]**. The `Key Confirmation` screen appears.

- 3 Press Δ or ∇ to select whether the key confirmation tone is enabled.
- 4 Press **[OK]**. The key confirmation tone setting is set and the `Buzzer` menu reappears.

Job Finish (Job completed tone setting)

When `On` is selected in this setting, a tone sounds when printing ends.

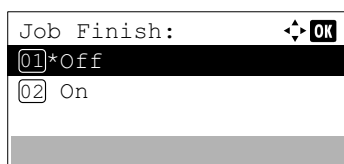

- 1 In the `Buzzer` menu screen, press Δ or ∇ to select `Job Finish`.
- 2 Press **[OK]**. The `Job Finish` screen appears.

- 3 Press Δ or ∇ to select whether the printing completed tone is enabled.
- 4 Press **[OK]**. The printing completed tone setting is set and the `Buzzer` menu reappears.

Ready (Preparation completed tone setting)

When **On** is selected in this setting, a tone sounds when print preparation has been completed.

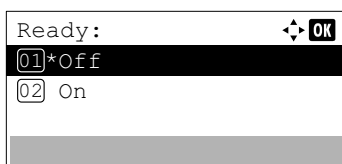

- 1 In the **Buzzer** menu screen, press Δ or ∇ to select **Ready**.
- 2 Press **[OK]**. The **Ready** screen appears.

- 3 Press Δ or ∇ to select whether the preparation completed tone is enabled.
- 4 Press **[OK]**. The preparation completed tone setting is set and the **Buzzer** menu reappears.

Error (Error tone setting)

When **On** is selected in this setting, a tone sounds when a problem such as running out of paper or a paper jam occurs during printing.

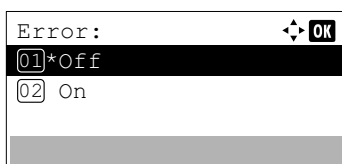

- 1 In the **Buzzer** menu screen, press Δ or ∇ to select **Error**.
- 2 Press **[OK]**. The **Error** screen appears.

- 3 Press Δ or ∇ to select whether the warning tone is enabled.
- 4 Press **[OK]**. The warning tone setting is set and the **Buzzer** menu reappears.

Keyboard Confirm (Keyboard confirmation tone setting)

When **On** is selected in this setting, a tone sounds each time a USB keyboard is used.



- 1 In the **Buzzer** menu screen, press Δ or ∇ to select **Keyboard Confirm**.
- 2 Press **[OK]**. The **Keyboard Confirm** screen appears.

- 3 Press Δ or ∇ to select whether the keyboard confirmation tone is enabled.
- 4 Press **[OK]**. The **Keyboard Confirm** tone setting is set and the **Buzzer** menu reappears.

RAM Disk Setting (Using the RAM disk)

The RAM disk is a memory space shared within the printer memory that can temporarily store print jobs. The stored print job can then be used to print multiple copies of the job reducing the total amount of time required to print the whole job. It acts similar to the SSD except that the data is effective only when the printer is powered up.

To use the RAM disk, activate and enter the desired size of the RAM disk in the manner described below. The maximum RAM disk size can be calculated as follows:

When the RAM disk is activated = The maximum RAM disk size is 16 MB (when no options are attached.)

When the optional memory is installed, the setting range varies depending on the amount of optional memory.

To activate RAM disk in the printer's memory, first you must set the RAM disk mode to `On` and set the desired data size for the RAM disk as described in the following section. This allows you to perform the following operations on the RAM disk.

 **Note** The RAM disk is an allocated part of the printer's memory.

IMPORTANT The RAM disk can not be used when an optional SSD is installed.

The RAM disk stores data only temporarily. When the printer is reset or turned off, the stored data will be erased.

The RAM disk allows some Job Box functions to be used.

The RAM disk is allocated from the printer memory available to users. If the size of the RAM disk is set too large, the printing speed may decrease or the memory may become insufficient.

The options available in RAM Disk Setting are as follows:

- RAM Disk Mode (Setting the RAM disk)...4-100
- RAM Disk Size (RAM disk size setting)...4-101

- 1 In the `Device Common` menu, press Δ or ∇ to select `RAM Disk Setting`.
- 2 Press **[OK]**. The `RAM Disk Setting` menu screen appears.

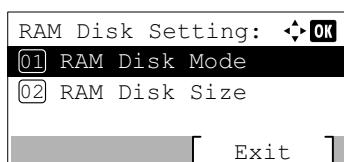

RAM Disk Mode (Setting the RAM disk)

Selecting `On` in this setting enables the RAM disk.

- 1 In the `RAM Disk Setting` menu, press Δ or ∇ to select `RAM Disk Mode`.
- 2 Press **[OK]**. The `RAM Disk Mode` screen appears.
- 3 Press Δ or ∇ to select whether the RAM disk is enabled.
- 4 Press **[OK]**. The RAM disk setting is set and the `RAM Disk Setting` menu reappears.

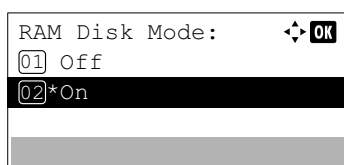

RAM Disk Size (RAM disk size setting)

Use this procedure to set the amount of memory used for the RAM disk.

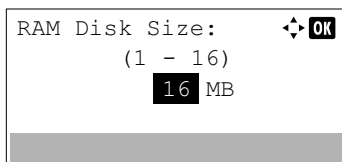

1 In the `RAM Disk Setting` menu, press Δ or ∇ to select `RAM Disk Size`.

2 Press **[OK]**. The `RAM Disk Size` screen appears.

3 Use the numeric keys or press Δ or ∇ to set the amount of memory to be used as a RAM disk.

The maximum amount of memory that can be set varies depending on the total amount of memory in the printer.

4 Press **[OK]**. The amount of memory used as a RAM disk is stored and the `RAM Disk Setting` menu reappears.

When you have completed the setting, exit the menu and restart the printer. The selected setting is valid after the printer starts up again.

Format SSD (Formatting the SSD)

When an optional SSD is inserted into the printer for the first time, it must be formatted before use.

This menu is displayed only when the SSD is installed on the printer.

 **Note** If the SSD is installed in the printer, the Document Box will be available. Formatting will destroy any existing data on a storage device including a used SSD. Formatting of the SSD must be executed from the printer. When the SSD has not yet been formatted, the Attention indicator flashes and `Format SSD` is displayed.

Use the procedure below to format the SSD.

When a new SSD is inserted in the printer's slot, `Format SSD` will appear on the message display.

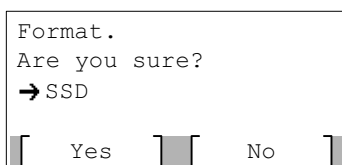

1 In the `Device Common` menu, press Δ or ∇ to select `Format SSD`.

2 Press **[OK]**. A confirmation screen appears.

3 Press **[Yes]** (**[Left Select]**). The `Formatting...` screen appears and SSD formatting begins. Once the formatting ends, the standby screen reappears.

Pressing **[No]** (**[Right Select]**) returns to the `Device Common` menu without formatting the SSD.

Format SD Card (Formatting the SD card)

The printer is equipped with a slot for an SD card.

A SD card must be formatted before it can be used in the printer. Formatting allows data to be written to the SD card.

 **Note** Formatting will destroy any existing data on a storage device including a used SD card.

Formatting of the SD card must be executed from the printer.

When a new SD card is inserted in the printer's slot, `Format SD Card` will appear on the message display.

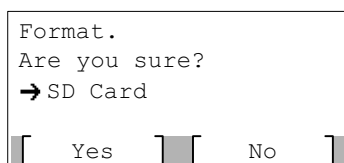

1 In the `Device Common` menu, press Δ or ∇ to select `Format SD Card`.

2 Press **[OK]**. A confirmation screen appears.

3 Press **[Yes]** (**[Left Select]**). The `Formatting SD card...` screen appears and SD card formatting begins. Once the formatting ends, the standby screen reappears.

Pressing **[No]** (**[Right Select]**) returns to the `Device Common` menu without formatting the SD card.

Display Bright. (Display brightness setting)

Sets the brightness of the message display.

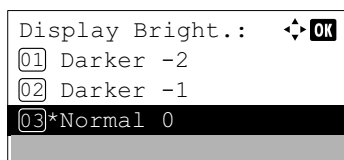

1 In the `Device Common` menu, press Δ or ∇ to select `Display Bright..`

2 Press **[OK]**. The `Display Bright.` screen appears showing the available brightness settings.

The list shows the following brightness settings:

Darker -2

Darker -1

Normal 0

Lighter +1

Lighter +2

3 Press Δ or ∇ to select the desired brightness.

4 Press **[OK]**. The brightness is set and the `Device Common` menu reappears.

Disp. Backlight (Display backlight setting)

Set the backlight for the message display.

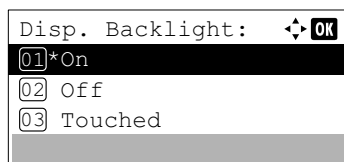

- 1 In the `Device Common` menu, press Δ or ∇ to select `Disp. Backlight`.
- 2 Press **[OK]**. The `Disp. Backlight` screen appears.
The list shows the following display backlight settings:
On (Standard)
Off (No backlight)
Touched (Backlight lights up when the key on the operation panel is pressed)



Note If `Touched` is selected, the backlight turns off again when the panel is reset after the setting time of `Auto Panel Reset` has passed or when **[Logout]** is pressed.

- 3 Press Δ or ∇ to select the desired backlight setting.
- 4 Press **[OK]**. The backlight setting is set and the `Device Common` menu reappears.

Error Handling (Error detection setting)

This specifies the settings for the detection methods used for duplex printing errors and for paper size and paper type errors when the paper source is fixed.

The options available in Error Handling are as follows:

- DuplexPaperError (Duplex printing error detection setting)...4-103
- Paper Mismatch (Detection settings for paper size/type errors when the paper source is fixed)...4-104
- InsertMismatch (Action when size error occurs during paper feeding)...4-104
- MP Tray Empty (Warning when the MP tray is empty)...4-104

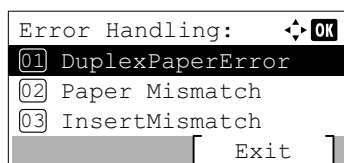

- 1 In the `Device Common` menu, press Δ or ∇ to select `Error Handling`.
- 2 Press **[OK]**. The `Error Handling` menu screen appears.

DuplexPaperError (Duplex printing error detection setting)

If the error detection setting for duplex printing has been turned `Display Error`, and you attempt to print onto a paper size and paper type that cannot be used for duplex printing, the `Duplex disabled` error message will be displayed and printing will stop.

1-sided	<ul style="list-style-type: none"> • To print onto one-side of the paper.
Display Error	<ul style="list-style-type: none"> • To print onto one-side of the paper only when this message is displayed, press [OK]. • Press [Cancel] to cancel the printing itself.

- 1 In the `Error Handling` menu, press Δ or ∇ to select `DuplexPaperError`.

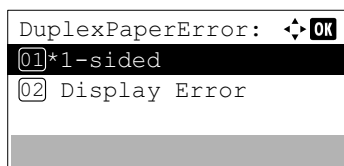

2 Press **[OK]**. The DuplexPaperError screen appears.

3 Press Δ or ∇ to select the setting for handling duplex paper errors.

4 Press **[OK]**. The handling of duplex paper errors is set and the Error Handling menu screen reappears.

Paper Mismatch (Detection settings for paper size/type errors when the paper source is fixed)

Select *Continue* in this setting if you want to continue printing even if the paper size or type you specified is different from the fixed paper source, or select *Display Error* to have the paper feed error displayed.

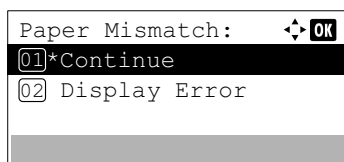

1 In the Error Handling menu, press Δ or ∇ to select Paper Mismatch.

2 Press **[OK]**. The Paper Mismatch screen appears.

3 Press Δ or ∇ to select the setting for handling paper mismatch errors.

4 Press **[OK]**. The handling of paper mismatch errors is set and the Error Handling menu screen reappears.

InsertMismatch (Action when size error occurs during paper feeding)

If the paper size you specified is different from the size of the paper that is fed when printing using a fixed paper source, you can select *Continue* to continue printing, or *Display Error* to have the paper feed error displayed.

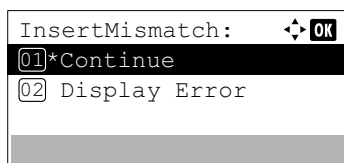

1 In the Error Handling menu, press Δ or ∇ to select InsertMismatch.

2 Press **[OK]**. The InsertMismatch screen appears.

3 Press Δ or ∇ to select the setting for handling Insert Mismatch errors.

4 Press **[OK]**. The handling of Insert Mismatch errors is set and the Error Handling menu screen reappears.

MP Tray Empty (Warning when the MP tray is empty)

Turn this setting to *On* if you want the error displayed when the MP tray is configured as the default paper source, and there is no paper in the MP tray, or turn it to *Off* not to have the error displayed.

The setting *On* enables the paper-empty message to display when the MP tray is empty.

1 In the Error Handling menu, press Δ or ∇ to select MP Tray Empty.

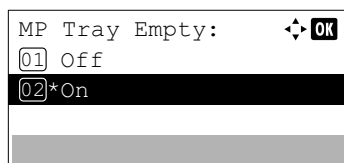

2 Press **[OK]**. The MP Tray Empty screen appears.

3 Press Δ or ∇ to select the setting for the paper-empty message to display.

4 Press **[OK]**. The display of MP Tray Empty is set and the Error Handling menu screen reappears.

Timer Setting

This specifies timer-related settings such as the automatic form-feed timeout and the timeout settings for Auto Sleep.

IMPORTANT To change the Timer Setting, the administrator's Login User Name and Login Password must be entered. For details of the administrator settings, refer to *Administrator on page 4-136*.

The options available in Timer Setting are as follows:

- Auto Panel Reset (Auto panel reset setting)...4-107
- PanelReset Timer (Setting the panel reset timer)...4-107
- Sleep Level Set. (Sleep level setting)...4-108
- Sleep Timer (Sleep timer timeout time)...4-110
- Power Off Rule (Power Off Rule setting) (for Europe)...4-110
- Power Off Timer (Power off timer settings) (for Europe)...4-111
- WeeklyTimer Set. (WeeklyTimer Settings)...4-112
- Auto Err. Clear (Auto error clear setting)...4-115
- Err. Clear Timer (Setting the error clear time)...4-116
- FormFeed TimeOut (Automatic form feed timeout setting)...4-116
- Ping Timeout (Setting the Ping Timeout time)...4-116

1 In the Device Common menu, press Δ or ∇ to select Timer Setting.

2 Press **[OK]**. The Login screen appears.



Note When user login administration is set:

- When logged in as an administrator, the log in screen is not displayed and the Timer Setting menu screen is displayed.
- The setting is not possible when logged in as anyone other than an administrator. Log in again as an administrator.

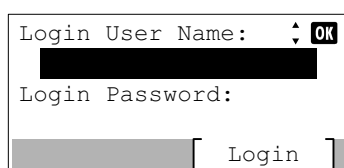

3 With the Login User Name entry field selected, press **[OK]**. The Login User Name entry screen is displayed.

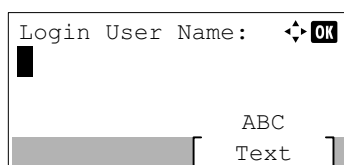

- 4 Enter the Login User Name using the numeric keys then press **[OK]**. The log in screen reappears.



Note The initial setting for the administrator's Login User Name is set as shown below.

ECOSYS P3045dn: 4500

ECOSYS P3050dn: 5000

ECOSYS P3055dn: 5500

ECOSYS P3060dn: 6000

For details on entering characters, refer to *Character Entry Method* on page A-2.

- 5 Press Δ or ∇ to select the Login Password entry field.

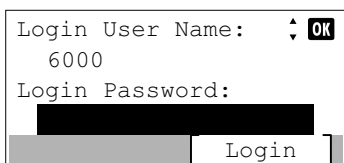

- 6 Press **[OK]**. The Login Password entry screen is displayed.

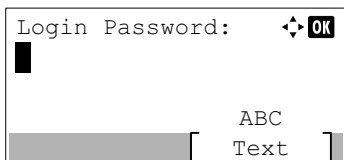

- 7 Enter the Login Password using the numeric keys then press **[OK]**. The login screen reappears.



Note The initial setting for the administrator's Login Password is set as shown below.

ECOSYS P3045dn: 4500

ECOSYS P3050dn: 5000

ECOSYS P3055dn: 5500

ECOSYS P3060dn: 6000

For details on entering characters, refer to *Character Entry Method* on page A-2.

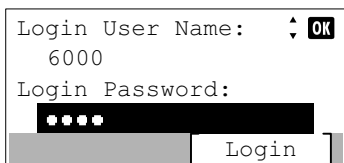

- 8 Pressing [Login] (**[Right Select]**). If the entered Login User Name and Login Password are correct, the Timer Setting menu appears showing a list of available options.

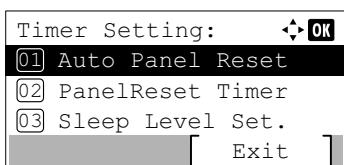

Auto Panel Reset (Auto panel reset setting)

The Auto Panel Reset function automatically restores the default settings if the panel is not used for a set time.

For setting the time until the panel is automatically reset, refer to *PanelReset Timer (Setting the panel reset timer)* on page 4-107.

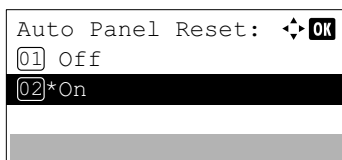

- 1 In the `Timer Setting` menu, press Δ or ∇ to select `Auto Panel Reset`.
- 2 Press **[OK]**. The `Auto Panel Reset` screen appears.
- 3 Press Δ or ∇ to select whether `Auto Panel Reset` is enabled.
- 4 Press **[OK]**. The `Auto Panel Reset` setting is set and the `Timer Setting` menu reappears.

PanelReset Timer (Setting the panel reset timer)

When `Auto Panel Reset` is set to `On`, this sets the time until the panel is automatically reset after the user stops using the panel.

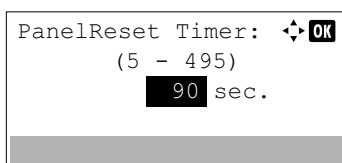

- 1 In the `Timer Setting` menu, press Δ or ∇ to select `PanelReset Timer`.
- 2 Press **[OK]**. The `PanelReset Timer` screen appears.
- 3 Use the numeric keys or press Δ or ∇ to set the panel reset time.
- 4 Press **[OK]**. The panel reset time setting is stored and the `Timer Setting` menu reappears.

Sleep Level Set. (Sleep level setting)

For Europe

This sets whether or not the machine enters sleep mode for each function.

 **Note** Sleep Level Set. menu is not displayed when the optional Network Interface Kit (IB-50), Wireless Network Interface Kit (IB-51) or Parallel Interface Kit (IB-32B) has been installed.

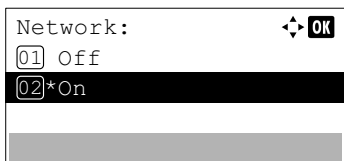
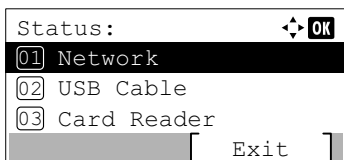
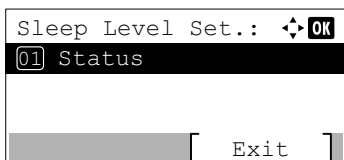

1 In the `Timer Setting` menu, press Δ or ∇ to select `Sleep Level Set..`

2 Press **[OK]**. The `Sleep Level Set.` menu screen appears.

3 Press Δ or ∇ to select `Status`.

4 Press **[OK]**. The `Status` menu screen appears.

Next set whether or not to use Energy Saver mode for each function.

Item	Default Value
Network (Network interface setting)	On
USB Cable (USB interface setting)	On
Card Reader (ID card reader setting)	Off
NIC (Option Network Interface Kit (NIC) setting)	Off
Parallel Cable (Parallel interface setting)	Off

 **Note** `Card Reader` is only displayed when the ID card reader function has been activated.

`Parallel Cable` is only displayed when the optional Parallel Interface Kit (IB-32B) has been installed.

5 Press Δ or ∇ to select which function to set.

6 Press **[OK]**. The screen for the function selected is displayed.

7 Press Δ or ∇ to select whether or not to use sleep mode. Select `On` to set the sleep mode.

8 Press **[OK]**. Set the sleep mode for each function and `Status` menu reappears.

 **Note** Repeat steps 5 to 8 to set sleep mode for a different function.

Except for Europe

There are two sleep modes with different levels of sleep: Quick Recovery and Energy Saver.

Quick Recovery Mode: The recovery from the sleep mode is faster than when using Energy Saver mode.

Energy Saver Mode: This makes it possible to reduce energy consumption even further than with Quick Recovery mode. With Energy Saver mode, you can set whether to enable the Energy Saver mode for each separate function.

 **Note** For information on the Quick Recovery mode and Energy Saver mode, refer to *Energy Saver Function on page 2-36*.
When the optional Network Interface Kit (IB-50), Wireless Network Interface Kit (IB-51) or Parallel Interface Kit (IB-32B) has been installed, the Sleep Level Set. menu is not displayed and the machine will enter the Quick Recovery mode.

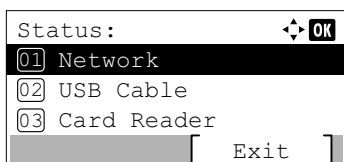
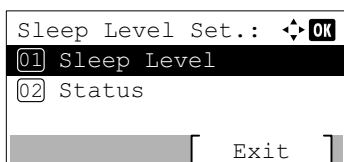
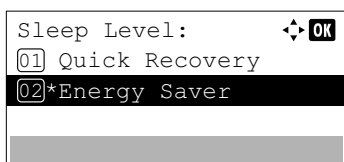
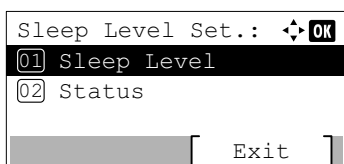

1 In the Timer Setting menu, press Δ or ∇ to select Sleep Level Set..

2 Press [OK]. The Sleep Level Set. menu screen appears.

3 Press Δ or ∇ to select Sleep Level.

4 Press [OK]. The Sleep Level screen appears.

5 Press Δ or ∇ to select Quick Recovery or Energy Saver.

6 Press [OK]. The sleep level is set and the Sleep Level Set. menu reappears.

When Energy Saver is set, next go on to set whether or not to use Energy Saver mode for each function.

7 Press Δ or ∇ to select Status.

 **Note** Status is only displayed when Energy Saver is set.

8 Press [OK]. The Status menu screen appears.

Next set whether or not to use Energy Saver mode for each function.

Item	Default Value
Network (Network interface setting)	On
USB Cable (USB interface setting)	On
Card Reader (ID card reader setting)	Off
NIC (Option Network Interface Kit (NIC) setting)	Off
Parallel Cable (Parallel interface setting)	Off

 **Note** Card Reader is only displayed when the ID card reader function has been activated.

Parallel Cable is only displayed when the optional Parallel Interface Kit (IB-32B) has been installed.

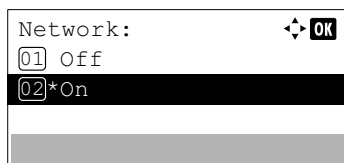

- 9 Press Δ or ∇ to select which function to set.
- 10 Press **[OK]**. The screen for the function selected is displayed.

- 11 Press Δ or ∇ to select whether or not to use Energy Saver mode. Select *On* to set the Energy Saver mode.
- 12 Press **[OK]**. Set the Energy Saver mode for each function and *Status* menu reappears.



Note Repeat steps 9 to 12 to set Energy Saver mode for a different function.

Sleep Timer (Sleep timer timeout time)

Set amount of time before entering Sleep. The printer reverts to normal operation mode when the printer receives a print job, **[OK]** is pressed or one of the exterior covers is opened.

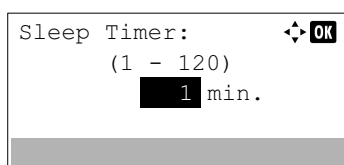

- 1 In the *Timer Setting* menu, press Δ or ∇ to select *Sleep Timer*.
- 2 Press **[OK]**. The *Sleep Timer* screen appears.

- 3 Use the numeric keys or Δ or ∇ to set the sleep time.
The timer can be set between 1 and 120 min (for Europe) or 1 and 240 min (except for Europe).
- 4 Press **[OK]**. The sleep time setting is stored and the *Timer Setting* menu reappears.

Power Off Rule (Power Off Rule setting) (for Europe)

The Power Off Rule is used to stop the power from automatically turning off when the machine is in certain states or certain settings are in effect. Rules that can be set and their initial settings are as follows:

Item	Default Value
Network (Network interface setting)	Off
USB Cable (USB interface setting)	Off
USB Host (USB memory slot setting)	On
RAM Disk (RAM Disk Mode setting) [†]	On
NIC (Option Network Interface Kit (NIC) setting)	Off
Parallel I/F (Parallel interface setting)	Off

[†] If the Power Off Rule is previously set to *On*, the machine turns off the power and all the data stored in the RAM Disk is deleted.



Note When *On* is set it automatically turns off.

NIC is only displayed when the optional Network Interface Kit (IB-50), Wireless Network Interface Kit (IB-51) or Wireless Network Interface Kit (IB-36) has been installed.

Parallel I/F is only displayed when the optional Parallel Interface Kit (IB-32B) has been installed.

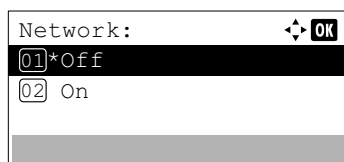
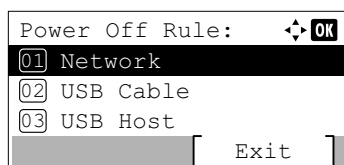

1 In the `Timer Setting` menu, press Δ or ∇ to select `Power Off Rule`.

2 Press **[OK]**. The `Power Off Rule` menu screen appears.

3 Press Δ or ∇ to select the condition to be set.

4 Press **[OK]**. The screen for the condition selected is displayed.

5 Press Δ or ∇ to select whether or not to have the power switch off.

6 Press **[OK]**. Set to switch the power off and the `Power Off Rule` menu reappears.



Note Repeat steps 3 to 6 to set for a different condition.

Power Off Timer (Power off timer settings) (for Europe)

The time until the power turns off can be set. The default setting is 3 days.

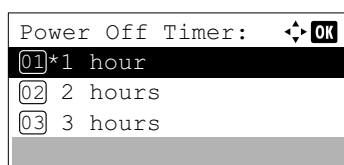

1 In the `Timer Setting` menu, press Δ or ∇ to select `Power Off Timer`.

2 Press **[OK]**. The `Power Off Timer` screen appears.

3 Press Δ or ∇ to select the time until the power goes off automatically. The times that can be set are 1 hour, 2 hours, 3 hours, 4 hours, 5 hours, 6 hours, 9 hours, 12 hours, 1 day, 2 days, 3 days, 4 days, 5 days, 6 days and 1 week.

4 Press **[OK]**. Set the time until the power switches off and the `Timer Setting` menu reappears.

WeeklyTimer Set. (WeeklyTimer Settings)

Configure settings for switching the machine to OFF and waking it automatically at a specified time for each day of the week.

The options available in the WeeklyTimer Set. are as follows:

- Weekly Timer (Weekly Timer settings)...4-112
- Schedule (Schedule settings)...4-112
- Retry Settings (Retry Settings)...4-114



- 1 In the Timer Setting menu, press Δ or ∇ to select WeeklyTimer Set..
- 2 Press [OK]. The WeeklyTimer Set. menu screen appears.

Weekly Timer (Weekly Timer settings)

Select whether to use Weekly Timer.

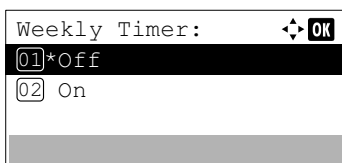

- 1 In the WeeklyTimer Set. menu, press Δ or ∇ to select Weekly Timer.
- 2 Press [OK]. The Weekly Timer screen appears.

- 3 Press Δ or ∇ to select On or Off.
- 4 Press [OK]. The Weekly Timer is set and the WeeklyTimer Set. menu reappears.

Schedule (Schedule settings)

Set the schedule for machine power off and on.

The options available in the WeeklyTimer Set. are as follows:

- Schedule (Schedule settings)...4-112
- Power On (Power On settings)...4-113
- Power Off (Power Off settings)...4-113

Schedule (Schedule settings)

Specify the time for each day of the week at which the machine turns OFF.

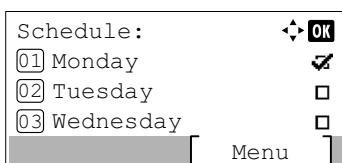

- 1 In the WeeklyTimer Set. menu, press Δ or ∇ to select Schedule.
- 2 Press [OK]. The Schedule screen appears.
- 3 Press Δ or ∇ to select the day of the week you want to set.

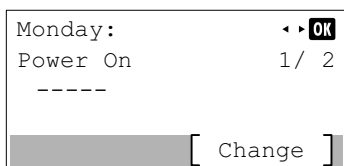

- 4 Press **[OK]**. The setting screen for the selected day of the week appears.

Power On (Power On settings)

Set the time at which the machine power will turn on.

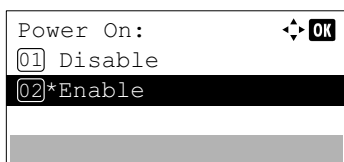

- 1 Press **[Change]** (**[Right Select]**). The `Power On` screen appears.

- 2 Press Δ or ∇ to select `Enable`.

- 3 Press **[OK]**. The `Power On Time` screen appears.

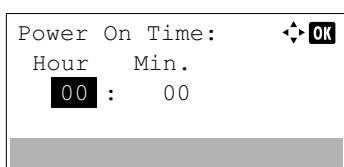

- 4 Press Δ or ∇ to set the `Power On Time`.

- 5 Press **[OK]**. The set `Power On Time` is saved and the setting screen of the selected day reappears.

Power Off (Power Off settings)

Set the time at which the machine power will turn off.

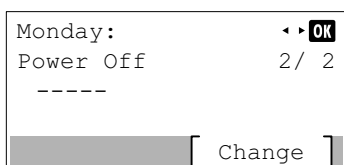

- 1 Press \triangleleft or \triangleright . The `Power Off` screen appears.

- 2 Press **[Change]** (**[Right Select]**). The `Power Off` screen appears.

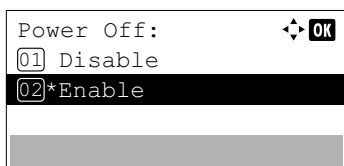

- 3 Press Δ or ∇ to select `Enable`.

- 4 Press **[OK]**. The `Power Off Time` screen appears.

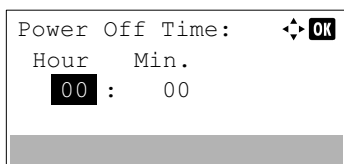

- 5 Press Δ or ∇ to set the `Power Off Time`.

- 6 Press **[OK]**. The set `Power Off Time` is saved and the setting screen of the selected day reappears.

Retry Settings (Retry Settings)

Select retry settings for machine power off.

The options available in the WeeklyTimer Set. are as follows:

- Retries (Retries settings)...4-114
- Retry Times (Retry Times settings)...4-114
- Retry Interval (Retry Interval settings)...4-114

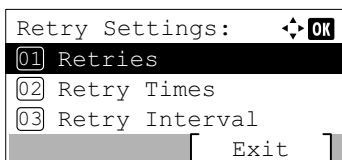

- 1 In the WeeklyTimer Set. menu, press Δ or ∇ to select Retry Settings.
- 2 Press [OK]. The Retry Settings menu screen appears.

Retries (Retries settings)

Set whether retry is attempted.

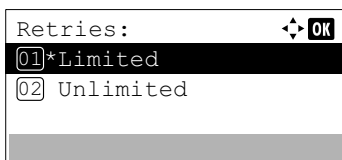

- 1 In the Retry Settings menu, press Δ or ∇ to select Retries.
- 2 Press [OK]. The Retries screen appears.

- 3 Press Δ or ∇ to select Limited or Unlimited.
- 4 Press [OK]. The Retries is set and the Retry Settings menu reappears.

Retry Times (Retry Times settings)

Set the number of retries.

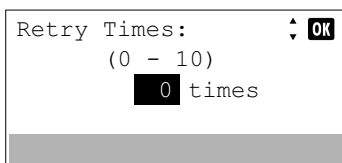

- 1 In the Retry Settings menu, press Δ or ∇ to select Retry Times.
- 2 Press [OK]. The Retry Times screen appears.

- 3 Press Δ or ∇ to set the Retry Times.
- 4 Press [OK]. The Retry Times setting is stored and the Retry Settings menu reappears.

Retry Interval (Retry Interval settings)

Set the retry interval.

- 1 In the Retry Settings menu, press Δ or ∇ to select Retry Interval.

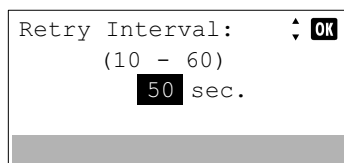

- 2** Press **[OK]**. The `Retry Interval` screen appears.
- 3** Press Δ or ∇ to set the `Retry Interval`.
- 4** Press **[OK]**. The `Retry Interval` setting is stored and the `Retry Settings` menu reappears.

Auto Err. Clear (Auto error clear setting)

If an error that still allows you to continue printing occurs, the next received data is automatically printed after a set period of time elapses.

For example, if the printer is shared over a network as a network printer and one person causes one of the above errors, after the set period of time elapses, the data sent from the next person is printed.

The auto clear errors are:

KPDL error.
 SSD error.
 RAM disk error.
 SD card error.
 Incorrect account ID.
 Account error.
 Cannot duplex print on this paper.
 Job Accounting restriction exceeded.
 No multi copies.
 USB memory error.
 Restricted by Job Accounting.
 Job not stored.

For the procedure for setting the automatic error recovery time, refer to *Err. Clear Timer (Setting the error clear time)* on page 4-116.

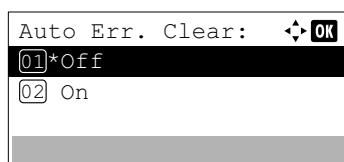

- 1** In the `Timer Setting` menu, press Δ or ∇ to select `Auto Err. Clear`.
- 2** Press **[OK]**. The `Auto Err. Clear` screen appears.
- 3** Press Δ or ∇ to select whether automatic error recovery is enabled.
- 4** Press **[OK]**. The automatic error recovery setting is set and the `Timer Setting` menu reappears.

Err. Clear Timer (Setting the error clear time)

If `Auto Err. Clear` is set to `On` and a non-fatal error (an error that allows printing to continue) occurs, this setting specifies the time until the error is recovered and printing resumes.

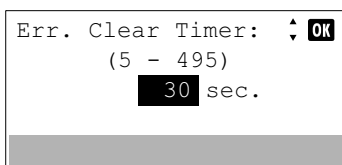

- 1 In the `Timer Setting` menu, press Δ or ∇ to select `Err. Clear Timer`.
- 2 Press **[OK]**. The `Err. Clear Timer` screen appears.
- 3 Use the numeric keys or press Δ or ∇ to set the recovery time.
- 4 Press **[OK]**. The recovery time setting is stored and the `Timer Setting` menu reappears.

FormFeed TimeOut (Automatic form feed timeout setting)

Receiving print data from the computer, the machine may sometimes wait if there is no information signalling that the last page does not have any more data to be printed. When the preset timeout passes, the machine automatically prints paper.

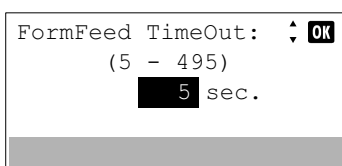

- 1 In the `Timer Setting` menu, press Δ or ∇ to select `FormFeed TimeOut`.
- 2 Press **[OK]**. The `FormFeed TimeOut` screen appears.
- 3 Use the numeric keys or press Δ or ∇ to set the form feed timeout delay.
- 4 Press **[OK]**. The form feed timeout setting is stored and the `Timer Setting` menu reappears.

Ping Timeout (Setting the Ping Timeout time)

Set the time until timeout occurs when `Ping` is executed in `Network`.

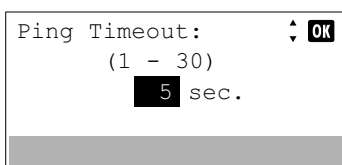

- 1 In the `Timer Setting` menu, press Δ or ∇ to select `Ping Timeout`.
- 2 Press **[OK]**. The `Ping Timeout` screen appears.
- 3 Use the numeric keys or press Δ or ∇ to set the `Ping Timeout` time.
- 4 Press **[OK]**. The `Ping Timeout` time setting is stored and the `Timer Setting` menu reappears.

Disp. Status/Log (Display Status/Log setting)

Set the display method of the Status/Log.

1 In the `Device Common` menu, press Δ or ∇ to select `Disp. Status/Log`.

2 Press **[OK]**. The Login screen appears.



Note When user login administration is set:

- When logged in as an administrator, the log in screen is not displayed and the `Disp. Status/Log` menu screen is displayed.
- The setting is not possible when logged in as anyone other than an administrator. Log in again as an administrator.

3 With the `Login User Name` entry field selected, press **[OK]**. The `Login User Name` entry screen is displayed.

4 Enter the Login User Name using the numeric keys then press **[OK]**. The log in screen reappears.



Note The initial setting for the administrator's Login User Name is set as shown below.

ECOSYS P3045dn: 4500

ECOSYS P3050dn: 5000

ECOSYS P3055dn: 5500

ECOSYS P3060dn: 6000

For details on entering characters, refer to *Character Entry Method* on page A-2.

5 Press Δ or ∇ to select the `Login Password` entry field.

6 Press **[OK]**. The `Login Password` entry screen is displayed.

- 7** Enter the Login Password using the numeric keys then press **[OK]**. The login screen reappears.



Note The initial setting for the administrator's Login Password is set as shown below.

ECOSYS P3045dn: 4500

ECOSYS P3050dn: 5000

ECOSYS P3055dn: 5500

ECOSYS P3060dn: 6000

For details on entering characters, refer to *Character Entry Method* on page A-2.

- 8** Pressing **[Login]** (**[Right Select]**). If the entered Login User Name and Login Password are correct, the Disp. Status/Log menu screen appears.

- 9** Press Δ or ∇ to select **JobsDetailStatus** or **Jobs Log**.

- 10** Press **[OK]**. The screen to set the display of jobs is displayed.

The setting of the display is as follows:

Show All (All users can view the jobs)

My Jobs Only (Only the user's own jobs are displayed.)

Hide All (Only users with administrator privileges can view the jobs)

- 11** Press Δ or ∇ to select the display setting.

- 12** Press **[OK]**. The display method is set and the Disp. Status/Log menu reappears.

USB KeyboardType (USB keyboard type selection)

Select the type of USB keyboard that you want to use.

- 1** In the Device Common menu, press Δ or ∇ to select **USB KeyboardType**.

- 2** Press **[OK]**. The USB KeyboardType screen appears.

The available USB keyboard types are as follows:

US

Europe US

France

Germany

- 3** Press Δ or ∇ to select the desired USB keyboard type.

- 4** Press **[OK]**. The USB keyboard type is set and the Device Common menu reappears.

Low Toner Alert (Setting for the alert level for toner addition)

This sets the toner addition alert level displayed on the status monitor.

1 In the `Device Common` menu, press Δ or ∇ to select `Low Toner Alert`.

2 Press **[OK]**. The Login screen appears.



Note When user login administration is set:

- When logged in as an administrator, the log in screen is not displayed and the `Low Toner Alert` menu screen is displayed.
- The setting is not possible when logged in as anyone other than an administrator. Log in again as an administrator.

3 With the `Login User Name` entry field selected, press **[OK]**. The `Login User Name` entry screen is displayed.

4 Enter the Login User Name using the numeric keys then press **[OK]**. The log in screen reappears.



Note The initial setting for the administrator's Login User Name is set as shown below.

ECOSYS P3045dn: 4500

ECOSYS P3050dn: 5000

ECOSYS P3055dn: 5500

ECOSYS P3060dn: 6000

For details on entering characters, refer to *Character Entry Method on page A-2*.

5 Press Δ or ∇ to select the `Login Password` entry field.

6 Press **[OK]**. The `Login Password` entry screen is displayed.

7 Enter the Login Password using the numeric keys then press **[OK]**. The login screen reappears.



Note The initial setting for the administrator's Login Password is set as shown below.

ECOSYS P3045dn: 4500

ECOSYS P3050dn: 5000

ECOSYS P3055dn: 5500

ECOSYS P3060dn: 6000

For details on entering characters, refer to *Character Entry Method on page A-2*.

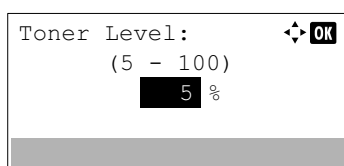
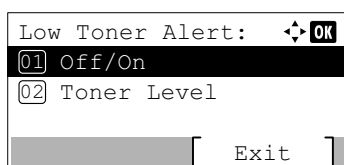
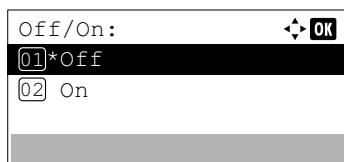
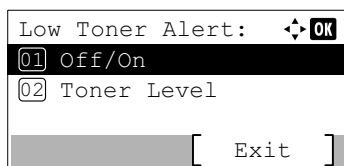

8 Pressing [Login] (**[Right Select]**). If the entered Login User Name and Login Password are correct, the Low Toner Alert menu screen appears.

9 Press Δ or ∇ to select Off/On.

10 Press [OK]. The Off/On screen appears.

11 Press Δ or ∇ to select whether Low Toner Alert is enabled.

12 Press [OK]. The Low Toner Alert screen appears.

13 Press Δ or ∇ to select Toner Level.

14 Press [OK]. The Toner Level screen appears.

15 Use the numeric keys or press Δ or ∇ to set the level at which an alert will be displayed. The setting is possible between 5 and 100%.

16 Press [OK]. The Toner Level is set and the Low Toner Alert menu reappears.

Msg Banner Print (Check setting before banner printing)

Set whether the confirmation screen appears before each sheet is printed when printing multiple banner sheets.

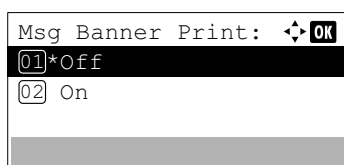

1 In the Device Common menu, press Δ or ∇ to select Msg Banner Print.

2 Press [OK]. The Msg Banner Print screen appears.

3 Press Δ or ∇ to select whether Msg Banner Print is enabled.

4 Press [OK]. The Msg Banner Print setting is set and the Device Common menu reappears.

Security (Security function setting)

The security functions can be set up to protect printer operation and the print data.

IMPORTANT To change the Security function settings, the administrator's Login User Name and Login Password must be entered. For details of the administrator settings, refer to *Administrator* on page 4-136.

The options available in Security are as follows:

- Network Security (Network security setting)...4-122
- I/F Block Set. (External interface block setting)...4-123
- Security Level...4-125
- Data Security (Data Security setting)...4-126

- 1 Press **[Menu]**.
- 2 Press Δ or ∇ to select **Security**.
- 3 Press **[OK]**. The Login screen appears.



Note When user login administration is set:

- When logged in as an administrator, the log in screen is not displayed and the **Security** menu screen is displayed.
- The setting is not possible when logged in as anyone other than an administrator. Log in again as an administrator.

- 4 With the **Login User Name** entry field selected, press **[OK]**. The **Login User Name** entry screen is displayed.

- 5 Enter the Login User Name using the numeric keys then press **[OK]**. The log in screen reappears.



Note The initial setting for the administrator's Login User Name is set as shown below.

ECOSYS P3045dn: 4500

ECOSYS P3050dn: 5000

ECOSYS P3055dn: 5500

ECOSYS P3060dn: 6000

For details on entering characters, refer to *Character Entry Method* on page A-2.

- 6 Press Δ or ∇ to select the **Login Password** entry field.

- 7 Press **[OK]**. The **Login Password** entry screen is displayed.

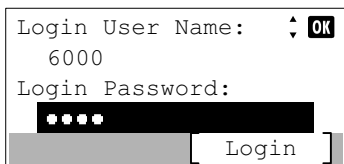

- 8 Enter the Login Password using the numeric keys then press **[OK]**. The log in screen reappears.



Note The initial setting for the administrator's Login Password is set as shown below.

ECOSYS P3045dn: 4500

ECOSYS P3050dn: 5000

ECOSYS P3055dn: 5500

ECOSYS P3060dn: 6000

For details on entering characters, refer to *Character Entry Method* on page A-2.

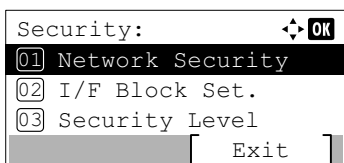

- 9 Pressing [Login] (**[Right Select]**). If the entered Login User Name and Login Password are correct, the Security menu screen appears.

Network Security (Network security setting)

Use this procedure to specify the security settings for each of the network protocols used.

IMPORTANT Check with your network administrator when selecting network settings.

The options available in Network Security are as follows:

- SSL Setting (SSL Server setting)...4-123

- 1 In the Security menu, press Δ or ∇ to select Network Security.
- 2 Press **[OK]**. The Network Security menu screen appears.

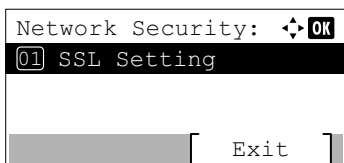

SSL Setting (SSL Server setting)

SSL (Secure Sockets Layer) refers to a protocol used to encrypt information sent and received over a network. SSL can currently be used to encrypt data such as the WWW or FTP files widely used on the Internet so that privacy-related information, credit card numbers, corporate secrets and other confidential information can be sent and received safely.

SSL servers use this protocol to authenticate servers and clients.

The options available in SSL Setting are as follows:

- SSL (SSL Server setting)...4-123

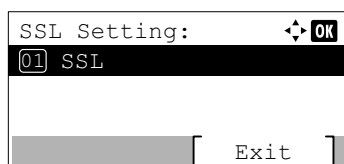

- 1 In the Network Security menu, press Δ or ∇ to select SSL Setting.
- 2 Press [OK]. The SSL Setting menu screen appears.

SSL (SSL Server setting)

Select whether or not to use the SSL server.

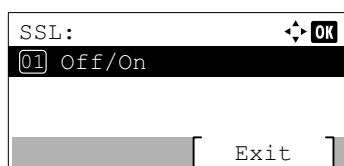

- 1 In the SSL Setting menu, press Δ or ∇ to select SSL.
- 2 Press [OK]. The SSL menu screen appears.

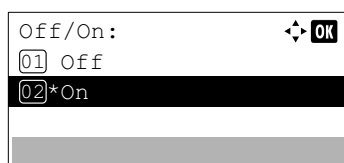

- 3 In the SSL menu, press Δ or ∇ to select Off/On.
- 4 Press [OK]. The Off/On screen appears.

- 5 Press Δ or ∇ to select whether to use the SSL server.
- 6 Press [OK]. The SSL server setting is set and the SSL menu reappears.

I/F Block Set. (External interface block setting)

You can use this to block and thereby protect the interface.

The options available in I/F Block Set. are as follows:

- USB Host (USB Port setting)...4-124
- USB Device (USB interface setting)...4-124
- Option I/F (Optional network interface setting)...4-124
- Parallel I/F (Parallel interface setting)...4-125
- USB Storage (USB memory setting)...4-125

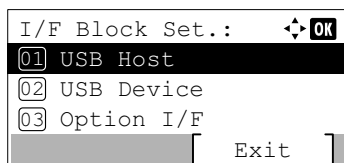

- 1** In the Security menu, press Δ or ∇ to select I/F Block Set..
- 2** Press **[OK]**. The I/F Block Set. menu screen appears.

USB Host (USB Port setting)

This blocks and protects the USB Port (USB Host).



- 1** In the I/F Block Set. menu, press Δ or ∇ to select USB Host.
- 2** Press **[OK]**. The USB Host screen appears.

- 3** Press Δ or ∇ to select whether to block and protect the USB host.
- 4** Press **[OK]**. The USB Host setting is set and the I/F Block Set. menu reappears.

USB Device (USB interface setting)

This blocks and protects the USB interface.

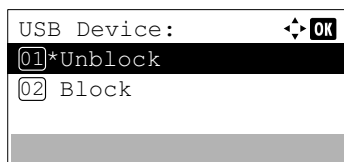

- 1** In the I/F Block Set. menu, press Δ or ∇ to select USB Device.
- 2** Press **[OK]**. The USB Device screen appears.

- 3** Press Δ or ∇ to select whether to block and protect the USB device.
- 4** Press **[OK]**. The USB Device setting is set and the I/F Block Set. menu reappears.

Option I/F (Optional network interface setting)

This blocks and protects the optional network interface.

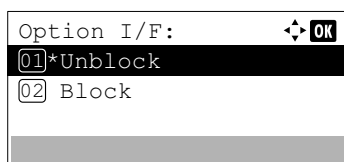

- 1** In the I/F Block Set. menu, press Δ or ∇ to select Option I/F.
- 2** Press **[OK]**. The Option I/F screen appears.

- 3** Press Δ or ∇ to select whether to block and protect the optional network interface.
- 4** Press **[OK]**. The Optional I/F setting is set and the I/F Block Set. menu reappears.

Parallel I/F (Parallel interface setting)

This blocks and protects the parallel interface.

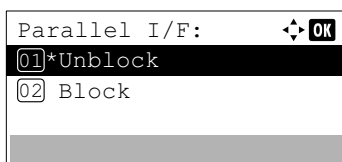

- 1** In the I/F Block Set. menu, press Δ or ∇ to select Parallel I/F.
- 2** Press **[OK]**. The Parallel I/F screen appears.
- 3** Press Δ or ∇ to select whether to block and protect the optional parallel interface.
- 4** Press **[OK]**. The Parallel I/F setting is set and the I/F Block Set. menu reappears.

USB Storage (USB memory setting)

This blocks and protects the USB storage (USB memory).

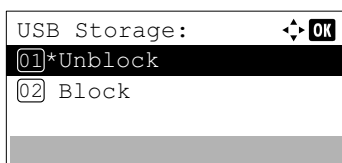

- 1** In the I/F Block Set. menu, press Δ or ∇ to select USB Storage.
- 2** Press **[OK]**. The USB Storage screen appears.
- 3** Press Δ or ∇ to select whether to block and protect the USB memory.
- 4** Press **[OK]**. The USB memory setting is set and the I/F Block Set. menu reappears.

Security Level

The Security Level setting is primarily a menu option used by service personnel for maintenance work. There is no need for customers to use this menu.

Data Security (Data Security setting)

This is to change the Security Password, initialize on optional SSD and sanitizing the stored data.

- SSD Initializ. (SSD Initialization setting)...4-126
- DataSanitization (Sanitizing the stored data)...4-128

 **Note** SSD Initializ. is displayed only when the optional SSD and Data Security Kit are installed.

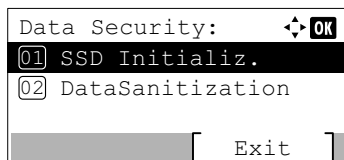

- 1 In the Security menu, press Δ or ∇ to select Data Security.
- 2 Press [OK]. The Data Security menu screen appears.

SSD Initializ. (SSD Initialization setting)

This is to change the Security Password and initialize on optional SSD.

- Security Passwd (Change the Security Password)...4-127
- Initialization (Initialize on optional SSD)...4-127

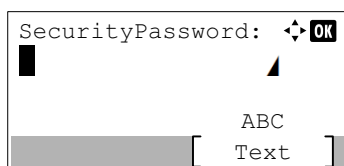

- 1 In the Data Security menu, press Δ or ∇ to select SSD Initializ..
- 2 Press [OK]. The SecurityPassword entry screen appears.

- 3 Enter the Security Password using the numeric keys.

 **Note** The initial setting for the Security Password is "000000". For details on entering characters, refer to *Character Entry Method* on page A-2.

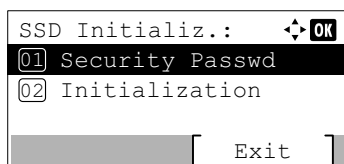

- 4 Press [OK]. If the Security Password entered is correct, the SSD Initializ. menu screen appears. If the Security Password entered was not correct, Incorrect password is displayed and the SecurityPassword screen reappears. Enter the correct Security Password.

Security Passwd (Change the Security Password)

Change the Security Password.

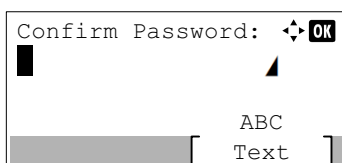
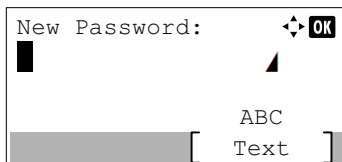

1 In the `SSD Initializ.` menu, press Δ or ∇ to select `Security Passwd`.

2 Press **[OK]**. The `New Password` entry screen appears.

3 Enter the new Security Password using the numeric keys.



Note The Security Password must be between 6 and 16 characters. For details on entering characters, refer to *Character Entry Method* on page A-2.

4 Press **[OK]**. The `Confirm Password` entry screen appears.

5 To confirm, re-enter the security password to be registered. Enter the new Security Password using the numeric keys.

6 Press **[OK]**. If the Security Password entered matches then the password is changed to the new password and the `SSD Initializ.` menu reappears.

If the password does not match, `Incorrect password` is displayed and the `New Password` entry screen reappears. Enter again from the new Security Password.

Initialization (Initialize on optional SSD)

Overwrite all the data stored in the optional SSD when disposing of the printer.

IMPORTANT If you accidentally turn the power switch off during initialization, the SSD might possibly crash or initialization might fail.

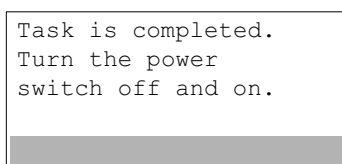
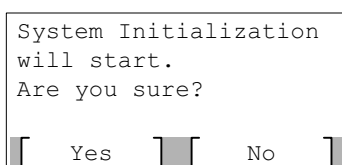

1 In the `SSD Initializ.` menu, press Δ or ∇ to select `Initialization`.

2 Press **[OK]**. A confirmation message is displayed.

3 Press **[Yes]** (**[Left Select]**). The printer automatically restarts and then initialization starts.

If you do not wish to initialize, press **[No]** (**[Right Select]**). The `SSD Initializ.` menu reappears.

4 When the initialization is finished `Task is completed.` is displayed. Turn the power switch off and then on.

DataSanitization (Sanitizing the stored data)

This is to completely delete the address information registered on the machine and the stored image data.

IMPORTANT To complete this process requires about a few minutes when an SSD is not installed, 30 minutes when an optional SSD (HD-6) is installed and 2 hours when an optional SSD (HD-7) is installed.

You can only performing this operation by logging in with machine administrator privileges.

It is not possible to cancel the process once it has started.

Remove the USB cable and network cable, etc., before performing this operation.

Do not turn off the power supply whilst the deletion is ongoing. If the power switch off during the deletion then the deletion will automatically be performed when the power is switched back on, but a complete operation cannot be guaranteed.

The data deleted is as listed below.

- Job settings
- Machine settings (Network settings)
- Certificates
- User settings (user list, document boxes)
- Machine administration (job logs, job accounting)

 **Note** It is possible to check the status of data sanitization implementation on the Status page. For details, refer to *Status Page (Printing a printer's status page)* on page 4-12.

```
Sanitize the data.
Are you sure?
* This process will
take a while.
[ Yes ] [ No ]
```

```
Sanitizing the data.
Main Memory : Complet
SSD          : Complet
[ OK ]
```

- 1 In the `Data Security` menu, press Δ or ∇ to select `DataSanitization`.
- 2 Press **[OK]**. A confirmation message is displayed.
- 3 Press **[Yes] ([Left Select])**. The message `Sanitizing the data.` appears and the data sanitization begins.

 **Note** When an optional SSD is installed, the printer automatically restarts before data sanitization.

Pressing **[No] ([Right Select])** returns to the `Data Security` menu without sanitizing the data.

- 4 When the data sanitization is finished `Complet` is displayed. Press **[OK] ([Right Select])** and turn the power switch off.

 **Note** It is possible to check the result of data sanitization on the Status page. For details, refer to *Status Page (Printing a printer's status page)* on page 4-12.

User/Job Account (User Login Setting/Job Account setting)

It is possible to set User Login Administration and Job Accounting on this machine.

User/ Job Account has the following items.

- User Login Set. (User login setting)...4-129
- Job Account.Set. (Job Account setting)...4-140
- Unknown ID Job (Operation settings for unknown IDs)...4-148

User Login Set. (User login setting)

User Login Administration is a function which makes it possible to specify the users who can use the machine and to manage the users. If the login user name and password entered match those already registered then the user is authenticated and can log in to the machine.

Users are classified into "User", "Administrator" or "DeviceAdmin", depending on their authority. The setting of security levels can only be done by DeviceAdmin.

The authentication for this machine uses a network authentication server. The registration of users is done on the server.

In the local user list for the machine, 1 user with administrator authority and 1 user with device administrator authority are registered. To change the administrator information, refer to *Administrator on page 4-136*.

When the optional Card Authentication Kit is activated, it is possible to log in using an ID card.

First User Login Administration

Follow these steps for the first user login administration.

Enable user login administration. (*page 4-131*)



Add a user on the network server.



Log out. (*page 4-136*)



The registered user logs in for operations. (*page 4-135*)

- 1 Press **[Menu]**.
- 2 Press Δ or ∇ to select *User/Job Account*.
- 3 Press **[OK]**. The Login screen appears.



Note When user login administration is set:

- When logged in as an administrator, the log in screen is not displayed and the *User/Job Account* menu screen is displayed.
- The setting is not possible when logged in as anyone other than an administrator. Log in again as an administrator.

- 4 With the *Login User Name* entry field selected, press **[OK]**. The *Login User Name* entry screen is displayed.

- 5 Enter the Login User Name using the numeric keys then press **[OK]**. The log in screen reappears.



Note The initial setting for the administrator's Login User Name is set as shown below.

ECOSYS P3045dn: 4500

ECOSYS P3050dn: 5000

ECOSYS P3055dn: 5500

ECOSYS P3060dn: 6000

For details on entering characters, refer to *Character Entry Method* on page A-2.

- 6 Press Δ or ∇ to select the Login Password entry field.

```

Login User Name:  6000
Login Password:
[ Login ]
    
```

- 7 Press **[OK]**. The Login Password entry screen is displayed.

```

Login Password:
[ ABC
  Text ]
    
```

- 8 Enter the Login Password using the numeric keys then press **[OK]**. The login screen reappears.



Note The initial setting for the administrator's Login Password is set as shown below.

ECOSYS P3045dn: 4500

ECOSYS P3050dn: 5000

ECOSYS P3055dn: 5500

ECOSYS P3060dn: 6000

For details on entering characters, refer to *Character Entry Method* on page A-2.

```

Login User Name:  6000
Login Password:
[ *****
  Login ]
    
```

- 9 Pressing [Login] (**[Right Select]**). If the entered Login User Name and Login Password are correct, the User/Job Account menu screen appears.

```

User/Job Account:
01 User Login Set.
02 Job Account.Set.
03 Unknown ID Job
[ Exit ]
    
```

- 10 Press Δ or ∇ to select User Login Set..

- 11 Press **[OK]**. The User Login Set. menu appears.

```

User Login Set.:
01 User Login
02 Local User List
[ Exit ]
    
```

User Login

This enables user login administration. This switches the User Login Administration On/Off and sets the authentication network server.

- 1 In the User Login Set. menu, press Δ or ∇ to select User Login.
- 2 Press [OK]. The User Login menu screen appears.

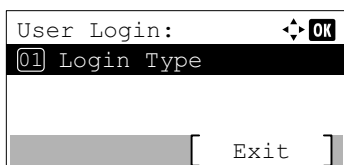

Login Type (Enabling of User Login Administration)

Select Netwk Authentic. to enable User Login Administration.

- 1 In the User Login menu, press Δ or ∇ to select Login Type.
- 2 Press [OK]. The Login Type screen appears.

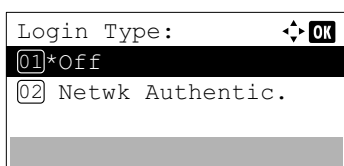
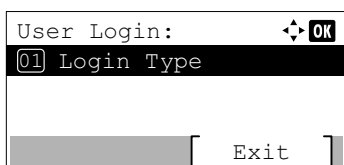

- 3 Press Δ or ∇ to select Netwk Authentic. or Off.

- 4 Press [OK]. The User Login menu reappears.



Note When Netwk Authentic. is selected, set the network authentication server.

Netwk Auth. Set (Netwk authentication setting)

Set the network authentication server.



Note These settings are only displayed when Netwk Authentic. has been set as the Login Type (Enabling of User Login Administration) on page 4-131.

- 1 In the User Login menu, press Δ or ∇ to select Netwk Auth. Set.
- 2 Press [OK]. The Netwk Auth. Set menu screen appears.

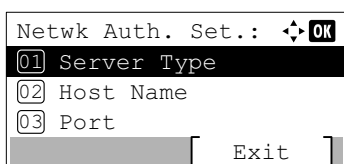

The options available in Netwk Auth. Set are as follows:

- Server Type (Server type selection)...4-132
- Host Name (Entering of Host Name)...4-132
- Port (Port number setting)...4-132
- Domain Name (Selecting of Domain Name)...4-133

Server Type (Server type selection)

Select the type of server for the authentication server.

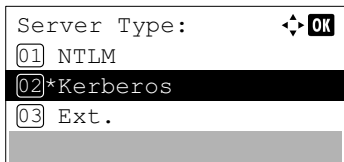

1 In the `Netwk Auth. Set` menu, press Δ or ∇ to select `Server Type`.

2 Press **[OK]**. The `Server Type` screen appears.

The available server types are as follows:

NTLM

Kerberos

Ext.

 **Note** Select `Ext.` to perform ID Card Authentication.

3 Press Δ or ∇ to select the desired server type.

4 Press **[OK]**. The server type is set and the `Netwk Auth. Set` menu reappears.

Host Name (Entering of Host Name)

Enter the host name for the authentication server.

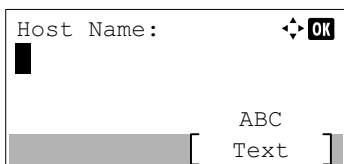

1 In the `Netwk Auth. Set` menu, press Δ or ∇ to select `Host Name`.

2 Press **[OK]**. The `Host Name` screen appears.

3 Enter the host name using the numeric keys.

 **Note** Up to 64 characters can be entered. For details on entering characters, refer to *Character Entry Method* on page A-2.

To enter the IPv6 address, enclose the address in brackets []. (e.g., [3ae3:9a0:cd05:b1d2:28a:1fc0:a1:10ae]:140)

4 Press **[OK]**. The `Domain` screen appears.

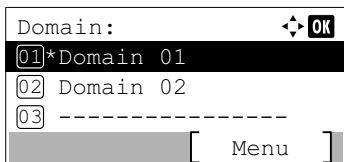

5 Referring to *Domain Name (Selecting of Domain Name)* on page 4-133, select the domain name for the authentication server.

6 Press **[OK]**. The host name is registered and the `Netwk Auth. Set` menu reappears.

Port (Port number setting)

Set the Port number for the authentication server.

 **Note** This setting is only displayed when `Ext.` has been set as the *Server Type (Server type selection)* on page 4-132.

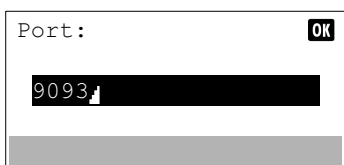

1 In the `Netwk Auth. Set` menu, press Δ or ∇ to select `Port`.

2 Press **[OK]**. The `Port` screen appears.

- 3 Enter the port number using the numeric keys.



Note If the port number is registered as a blank field, the default port number will be enabled.

- 4 Press **[OK]**. The port number is registered and the `Netwk Auth. Set` menu reappears.

Domain Name (Selecting of Domain Name)

Enter the domain name for the authentication server.



Note This setting is only displayed when `NTLM` or `Kerberos` has been set as the *Server Type (Server type selection)* on page 4-132.

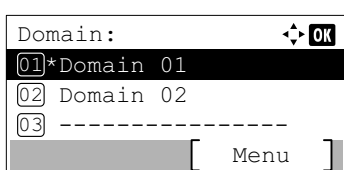

- 1 In the `Netwk Auth. Set` menu, press Δ or ∇ to select `Domain Name`.
- 2 Press **[OK]**. The `Domain` screen appears.

- 3 Press Δ or ∇ to select the domain name for the authentication server, and press **[OK]**. The domain is registered and the `Netwk Auth. Set` menu reappears.

If the domain has not been set, select the number where ----- is displayed and press `[Menu]` (**[Right Select]**).

- 4 Press Δ or ∇ to select `Edit`.
- 5 Press **[OK]**. The `Domain` screen appears.

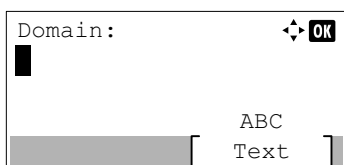

- 6 Enter the domain name using the numeric keys.



Note Up to 256 characters can be entered. For details on entering characters, refer to *Character Entry Method* on page A-2.

- 7 Press **[OK]**. The `Domain` menu reappears.
- 8 Check if the entered domain name is selected, press **[OK]**. The domain name is registered and the `Netwk Auth. Set` menu reappears.

NW User Property (Obtain the network user property)

This setting is to acquire user information from the LDAP server.



Note This setting is only displayed when `Netwk Authentic.` has been set as the *Login Type (Enabling of User Login Administration)* on page 4-131 and `NTLM` or `Kerberos` has been set as the *Server Type (Server type selection)* on page 4-132.

- 1 In the `User Login Set.` menu, press Δ or ∇ to select `NW User Property`.

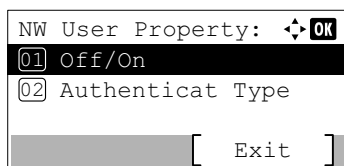

2 Press **[OK]**. The NW User Property menu screen appears.

The options available in NW User Property are as follows:

- Off/On (Switching network user property acquisition On/Off)...4-134
- Authenticat Type (Authenticat type setting)...4-134



Note Authenticat Type is only displayed when Kerberos has been set as the Server Type (Server type selection) on page 4-132.

Off/On (Switching network user property acquisition On/Off)

Set the NW User Property to On/Off.

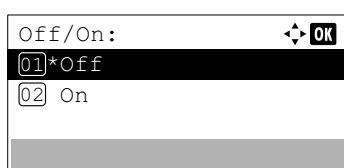

1 In the NW User Property menu, press Δ or ∇ to select Off/On.

2 Press **[OK]**. The Off/On screen appears.

3 Press Δ or ∇ to select On or Off.

4 Press **[OK]**. The NW User Property menu reappears.

Authenticat Type (Authenticat type setting)

Set the authentication method.

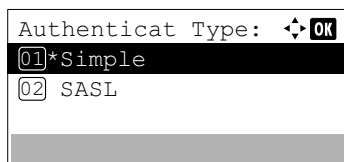

1 In the NW User Property menu, press Δ or ∇ to select Authenticat Type.

2 Press **[OK]**. The Authenticat Type screen appears.

3 Press Δ or ∇ to select Simple or SASL.

4 Press **[OK]**. The NW User Property menu reappears.

PIN Login

This sets whether or not to login using PIN. When set to On, you can login by entering PIN on the login screen.



Note This setting is only displayed when Netwk Authentic. has been set as the Login Type (Enabling of User Login Administration) on page 4-131 and This setting is only displayed when Ext. has been set as the Server Type (Server type selection) on page 4-132.

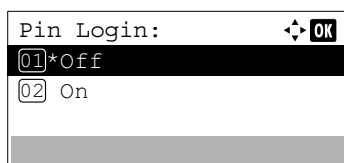

1 In the User Login Set. menu, press Δ or ∇ to select PIN Login.

2 Press **[OK]**. The PIN Login screen appears.

3 Press Δ or ∇ to select On or Off.

4 Press **[OK]**. The User Login Set. menu reappears.

Login/Logout

Once you enable user login administration, a login user name and password entry screen appears each time you use this machine. Enter the user information registered on the network authentication server as the login user name and password.

Register new users from the KYOCERA Net Manager. For details, refer to the *KYOCERA Net Manager Install Manual*.

 **Note** To carry out operations restricted in the mode selection menu operation and Lock Operation Panel settings, it is necessary to log in as a user with administrator authority.

For the administrator settings, refer to *Administrator on page 4-136*.

For Lock Operation Panel, refer to *Command Center RX User Guide*.

Login

Use the procedure below to login.

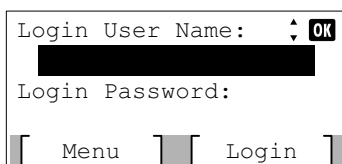

- 1 With the **Login User Name** entry field selected, press **[OK]**. The **Login User Name** entry screen is displayed.

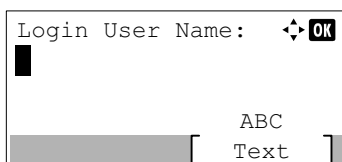

- 2 Enter the **Login User Name** using the numeric keys then press **[OK]**. The login screen reappears.

 **Note** For details on entering characters, refer to *Character Entry Method on page A-2*.

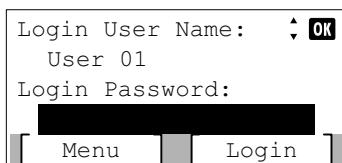

- 3 Press Δ or ∇ to select the **Login Password** entry field.

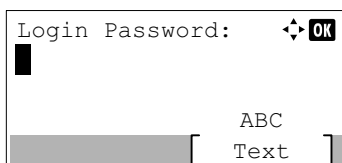

- 4 Press **[OK]**. The **Login Password** entry screen is displayed.

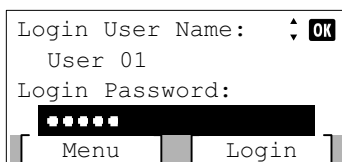

- 5 Enter the **Login Password** using the numeric keys then press **[OK]**. The login screen reappears.

 **Note** For details on entering characters, refer to *Character Entry Method on page A-2*.

- 6 Check that the correct login user name and password have been entered then press **[Login]** (**[Right Select]**).

 **Note** When Job Accounting is set, it is possible to press **[Menu]** (**[Left Select]**) then select **Counter** on the menu displayed and press **[OK]** to see the number of pages printed.

Logout

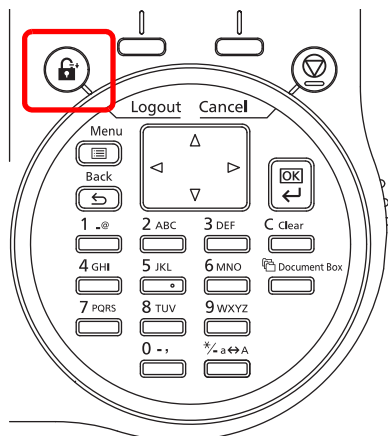

When the operations are finished, press **[Logout]**. The login screen reappears.

Auto Logout

Logout is automatically executed in the following cases:

- When the power supply is off
- When the machine enters the sleep mode after the setting time of Auto Sleep has passed
- When the power of the machine turns off after the setting time of auto power off has passed
- When the settings are restored to the default after the setting time of Auto Panel Reset has passed

Administrator

In the local user list for the machine, 1 user with administrator authority and 1 user with device administrator authority are registered.

Each user's properties are:

Machine Administrator		Administrator	
User Name:	DeviceAdmin	User Name:	Admin
Login User Name:	ECOSYS P3045dn: 4500 ECOSYS P3050dn: 5000 ECOSYS P3055dn: 5500 ECOSYS P3060dn: 6000	Login User Name:	Admin
Login Password:	ECOSYS P3045dn: 4500 ECOSYS P3050dn: 5000 ECOSYS P3055dn: 5500 ECOSYS P3060dn: 6000	Login Password:	Admin
Access Level:	Machine Administrator	Access Level:	Administrator

Changing the administrator information

It is possible to change the administrator information. Use the procedure below to change the details registered.

Note Log in as DeviceAdmin to change the administrator information. When logged in as Admin., it is only possible to check the administrator information.

- 1 In the User Login Set. menu, press Δ or ∇ to select Local User List.
- 2 Press **[OK]**. The Local User List screen appears.
- 3 Press Δ or ∇ to select the administrator to change.

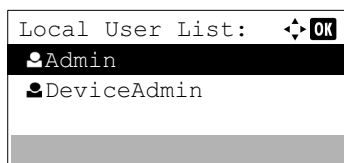

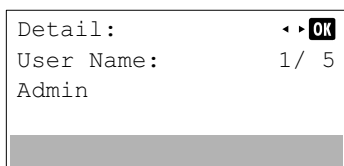

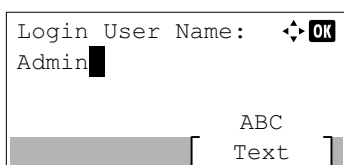
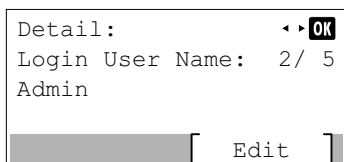

To change the Login User Name

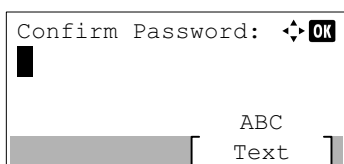
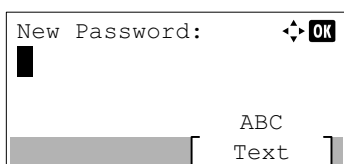

To change the Login Password



- 4 Press **[OK]**. The detailed information for the user is displayed.
- 5 Press **<** or **>** to select `Login User Name`.
- 6 Pressing **[Edit]** (**[Right Select]**). The screen for editing the `Login User Name` appears.
 -  **Note** Up to 32 characters can be entered. For details on entering characters, refer to *Character Entry Method on page A-2*.
- 7 Change the `Login User Name` using the numeric keys and press **[OK]**. The `Login User Name` screen reappears.
- 8 Press **<** or **>** to select `Login Password`.
- 9 Pressing **[Edit]** (**[Right Select]**). The `New Password` screen appears.
- 10 Enter the new password using the numeric keys and press **[OK]**. The `Confirm Password` screen reappears.
 -  **Note** Up to 64 characters can be entered. For details on entering characters, refer to *Character Entry Method on page A-2*.
- 11 To confirm, re-enter the password to be registered. Enter the `Password` using the numeric keys.
- 12 Press **[OK]**. If the `Password` matches then the password is changed to the new one and the `Login Password` screen reappears.

If the password does not match, `Incorrect password` is displayed and the `New Password` screen reappears. Enter again from the new `Password`.

To change the E-mail Address

13 Press < or > to select E-mailAddress.

14 Pressing [Edit] ([Right Select]). The Address Entry screen appears.

15 Change the address using the numeric keys and press [OK]. The E-mailAddress screen reappears.



Note Up to 128 characters can be entered. For details on entering characters, refer to *Character Entry Method* on page A-2.

To change the Account ID

Note This item is only displayed when Job Account is set.

16 Press < or > to select Account ID.

17 Pressing [Change] ([Right Select]). The Account ID screen appears.

18 Press Δ or ∇ to select the Account ID and press [OK]. The Account ID screen reappears.



Note For other accounts, select Others.

ID Card Settings

This sets the login method when the optional Card Authentication Kit is used and users are managed using ID cards.

Note This item is only displayed when the optional Card Authentication Kit is activated. For details of the Card Authentication Kit, refer to *Card Authentication Kit(B) Operation Guide for Printer*.

1 In the User Login Set. menu, press Δ or ∇ to select ID Card Settings.

2 Press [OK]. The ID Card Settings menu screen appears.

The options available in ID Card Settings are as follows:

- Key Login (Setting for key login permission)...4-139
- Additional Auth. (Setting for additional authentication)...4-139

Key Login (Setting for key login permission)

This setting also permits logging in using the numeric keys on the ID card login screen. When `Permit` is set, `KeyLogin` is displayed on the login screen and it is possible to log in by entering the Login User Name and Login Password using the numeric keys. When `Prohibit` is set, it is not possible to log in using the numeric keys.

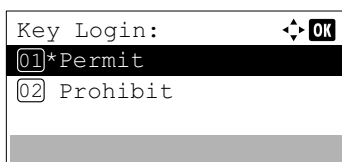

- 1 In the ID Card Settings menu, press Δ or ∇ to select `Key Login`.
- 2 Press **[OK]**. The `Key Login` screen appears.

- 3 Press Δ or ∇ to select `Permit` or `Prohibit`.
- 4 Press **[OK]**. The ID Card Settings menu reappears.

Additional Auth. (Setting for additional authentication)

This sets whether or not to require the entry of a Login Password or PIN (Personal Identification Number) after authentication using an ID card. When set to `On`, the Login Password or PIN entry screen is displayed after the ID card is authenticated.

 **Note** This setting is only displayed when `Ext.` has been set as the *Server Type (Server type selection)* on page 4-132.

When `Use PIN` is selected in this setting, even if the `PIN Login` is set to `Off`, you can enter PIN for additional authentication.

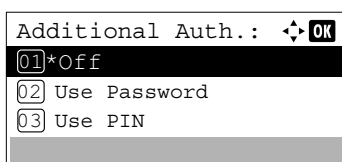

- 1 In the ID Card Settings menu, press Δ or ∇ to select `Additional Auth..`
- 2 Press **[OK]**. The `Additional Auth.` screen appears.

- 3 Press Δ or ∇ to select `Off`, `Use Password` or `Use PIN`.
- 4 Press **[OK]**. The ID Card Settings menu reappears.

Job Account.Set. (Job Account setting)

Job Accounting is a function that allows the number of pages used by each department to be managed through the use of entered account IDs. To specify the Job Accounting settings, it is necessary to log in with an administrator's Login User Name and Login Password. For details of User Login Administration, refer to *User Login Set. (User login setting)* on page 4-129.

Job accounting on this machine offers the following features:

- Support for up to 100 departments
- Account IDs up to 8 digits long from 1 to 99999999
- Collective print management for the same account ID
- Totaling of the number of pages used for each department
- Specifiable limits (1 to 9,999,999) on the number of pages used

The options available in the Job Account.Set menu are as follows:

- Job Accounting (Enabling Job Accounting)...4-141
- AccountingAccess (Setting the job accounting access)...4-142
- Account.(Local) (Job Accounting settings)...4-142
- Apply Limit (Operation settings when limits are exceeded)...4-147

- 1 Press **[Menu]**.
- 2 Press Δ or ∇ to select `User/Job Account`.
- 3 Press **[OK]**. The Login screen appears.



Note When user login administration is set:

- When logged in as an administrator, the log in screen is not displayed and the `User/Job Account` menu screen is displayed.
- The setting is not possible when logged in as anyone other than an administrator. Log in again as an administrator.

- 4 With the `Login User Name` entry field selected, press **[OK]**. The `Login User Name` entry screen is displayed.

- 5 Enter the Login User Name using the numeric keys then press **[OK]**. The log in screen reappears.



Note The initial setting for the administrator's Login User Name is set as shown below.

ECOSYS P3045dn: 4500

ECOSYS P3050dn: 5000

ECOSYS P3055dn: 5500

ECOSYS P3060dn: 6000

For details on entering characters, refer to *Character Entry Method* on page A-2.

- 6 Press Δ or ∇ to select the `Login Password` entry field.

7 Press **[OK]**. The Login Password entry screen is displayed.

8 Enter the Login Password using the numeric keys then press **[OK]**. The login screen reappears.



Note The initial setting for the administrator's Login Password is set as shown below.

ECOSYS P3045dn: 4500

ECOSYS P3050dn: 5000

ECOSYS P3055dn: 5500

ECOSYS P3060dn: 6000

For details on entering characters, refer to *Character Entry Method* on page A-2.

9 Pressing **[Login]** (**[Right Select]**). If the entered Login User Name and Login Password are correct, the User/Job Account menu screen appears.

10 Press Δ or ∇ to select Job Account.Set..

11 Press **[OK]**. The Job Account.Set. menu appears.

Job Accounting (Enabling Job Accounting)

Enable job accounting. Use the procedure below.

1 In the Job Account.Set. menu, press Δ or ∇ to select Job Accounting.

2 Press **[OK]**. The Job Accounting screen appears.

3 Press Δ or ∇ to select On or Off and then press **[OK]**. The Job Account.Set. menu reappears.

AccountingAccess (Setting the job accounting access)

Set the job accounting access.

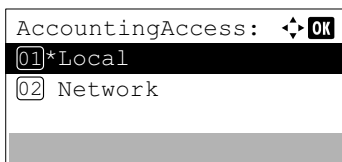

- 1 In the `Job Account.Set.` menu, press Δ or ∇ to select `AccountingAccess`.
- 2 Press **[OK]**. The `AccountingAccess` screen appears.

- 3 Press Δ or ∇ to select `Local` or `Network`, and press **[OK]**. The `Job Account.Set.` menu reappears.



Note To select `Network`, network authentication must be enabled and the server type must be set. For details, refer to *Netwk Auth. Set (Netwk authentication setting)* on page 4-131.

Account.(Local) (Job Accounting settings)

You can add, change and delete an account, set the restriction for each account, and count the number of pages printed.

The options available in the `[Account.(Local)]` menu are as follows:

- `Account. Report (Account report printing)...`4-142
- `Each Job Account (Totals display by account)...`4-143
- `Account. List (Account List operation)...`4-144

- 1 In the `Job Account.Set.` menu, press Δ or ∇ to select `Account.(Local)`.
- 2 Press **[OK]**. The `Account.(Local)` screen appears.

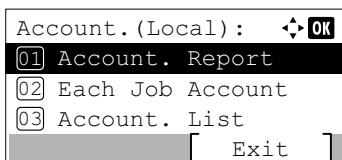

Account. Report (Account report printing)

This enables you to print the total number of pages for all accounts as a Job Accounting list.

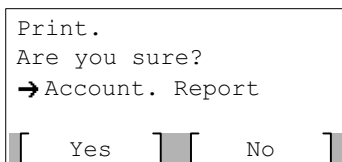

- 1 In the `Account.(Local)` menu, press Δ or ∇ to select `Account. Report`.
- 2 Press **[OK]**. A confirmation screen appears.

Press **[Yes] ([Left Select])**. `Accepted.` appears and the printer prints the job accounting list.

Pressing **[No] ([Right Select])** returns to the `Account.(Local)` menu without printing the job accounting list.

Each Job Account (Totals display by account)

Displays the number of pages printed for each of the currently selected accounts.

This enables you to check the following numbers for printed pages:

- Total
- Combine (None)
- Combine (2in1)
- Combine (4in1)
- Duplex (1side)
- Duplex (2side)

 **Note** Before carrying out this operation, register the Account in the *Account. List (Account List operation)* on page 4-144.

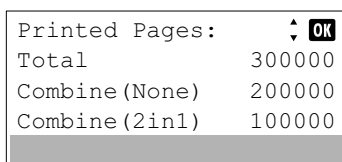
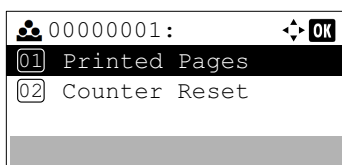
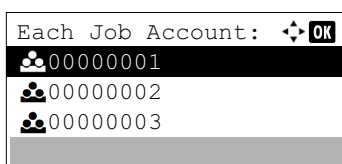

- 1** In the *Account. (Local)* menu, press Δ or ∇ to select *Each Job Account*.
- 2** Press **[OK]**. The *Each Job Account* menu appears with the accounts with the highest numbers listed first.
- 3** Press Δ or ∇ to select an account and then press **[OK]**. The *Printed Pages/Counter Reset* menu screen appears.
- 4** Press Δ or ∇ to select *Printed Pages*.
- 5** Press **[OK]**. The *Printed Pages* menu list screen appears.
- 6** Press Δ or ∇ to check the required counter display.
- 7** Press **[OK]**. The *Printed Pages/Counter Reset* menu screen reappears.

Each Job Account Counter Reset (Totals reset by account)

Resets the number of pages printed for each of the accounts currently set.

 **Note** Before carrying out this operation, register the Account in the *Account. List (Account List operation)* on page 4-144.

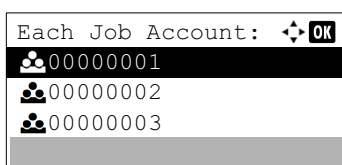

- 1** In the *Account. (Local)* menu, press Δ or ∇ to select *Each Job Account*.
- 2** Press **[OK]**. The *Each Job Account* menu appears with the accounts with the highest numbers listed first.

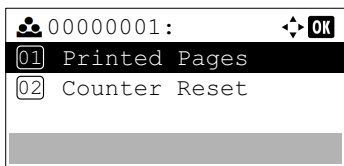

3 Press Δ or ∇ to select an account and then press **[OK]**. The Printed Pages/Counter Reset menu screen appears.

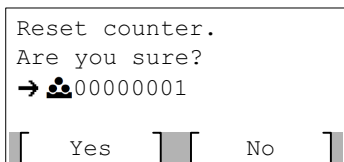

4 Press Δ or ∇ to select Counter Reset.

5 Press **[OK]**. The reset confirmation menu screen appears. To proceed with resetting the counter, press [Yes] (**[Left Select]**). Completed. appears, the counter is reset and the Printed Pages/Counter Reset menu reappears. Pressing [No] (**[Right Select]**) returns to the Printed Pages/Counter Reset menu screen without resetting the counter.

Account. List (Account List operation)

This specifies the setting for the department to be used for setting Job Accounting.

Add (Account registration)

Use this procedure to add a new account.

 **Note** Because account IDs are managed as numeric strings, "1" and "001" are handled as different accounts. Also, once Job Accounting is enabled, no jobs are printed unless information is attached showing the accounts from which the jobs are being printed.

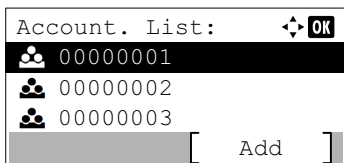

1 In the Account. (Local) menu, press Δ or ∇ to select Account. List.

2 Press **[OK]**. The Account. List menu appears showing a list of the registered accounts in ascending order.

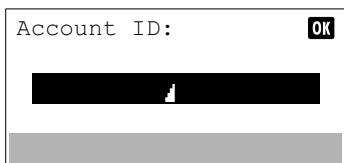

3 Press [Add] (**[Right Select]**). The Account ID menu screen appears.

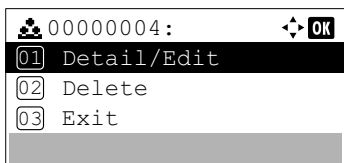

4 Use the numeric keys to enter the account ID to be added.

5 Press **[OK]**. Once the account has been added, a list of selection options appears.

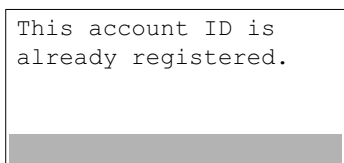

This message appears if the account ID has already been registered.

Detail/Edit (Checking/editing registered account ID settings)

This procedure allows you to check or edit registered accounts.

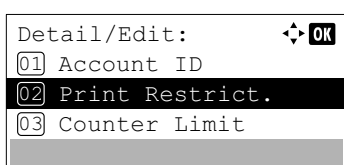
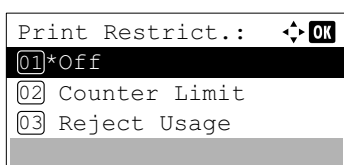
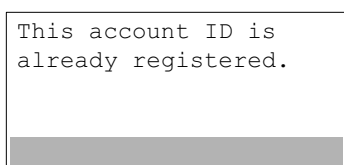
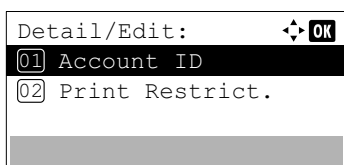
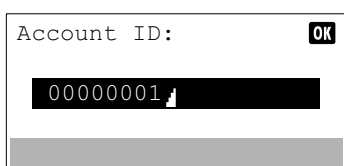
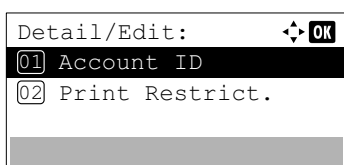
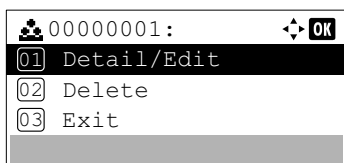
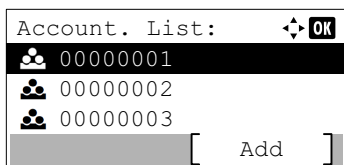

- 1 In the Account . (Local) menu, press Δ or ∇ to select Account . List.
 - 2 Press **[OK]**. The Account . List menu appears showing a list of the registered accounts in ascending order.
 - 3 Press Δ or ∇ to select an account to check or edit and then press **[OK]**. A list of selection options appears.
 - 4 Press Δ or ∇ to select Detail/Edit and then press **[OK]**. The Detail/Edit menu screen appears.
 - 5 To edit an account ID, press Δ or ∇ to select Account ID and then press **[OK]**. The Account ID menu screen appears.
 - 6 Use the numeric keys to enter the new account ID.
 - 7 Press **[OK]**. When account ID editing has been completed, the Detail/Edit menu screen appears.
- This message appears if the account ID has already been registered.
- 8 To place printing restrictions on this account, press Δ or ∇ to select Print Restrict. and then press **[OK]**. The Print Restrict. screen appears.
 - Off
 - Counter Limit
 - Reject Usage
 - 9 Press Δ or ∇ to select a setting and then press **[OK]**. When the setting has been completed, the Detail/Edit menu screen appears.

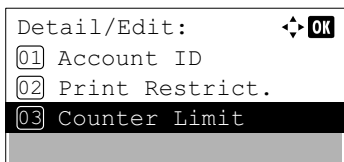
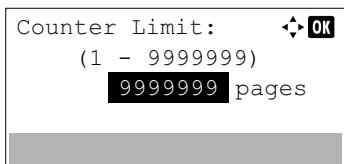

Delete (Deleting registered accounts)

You can use this procedure to delete a registered account ID.

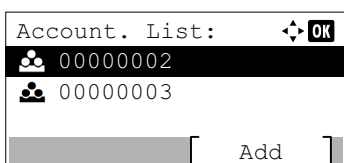
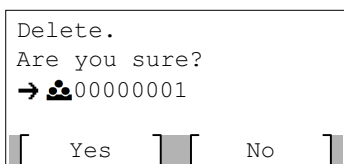
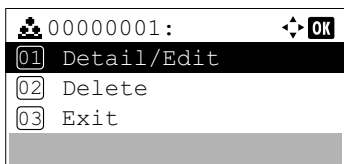
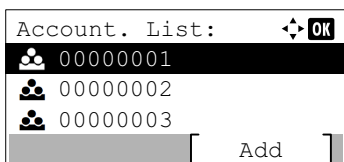

10 When Counter Limit is set for Print Restrict. in step 9, set the limit on the total number of pages that can be printed using this account. Press Δ or ∇ to select Counter Limit and then press [OK]. The Counter Limit menu screen appears.

IMPORTANT Counter Limit is displayed when Counter Limit is set for Print Restrict..

11 Use the numeric keys or Δ or ∇ to enter the limit you want to set for this account. After you have entered the limit on the number of pages, press [OK]. The setting is stored and the Detail/Edit menu reappears.

1 In the Account. (Local) menu, press Δ or ∇ to select Account. List.

2 Press [OK]. The Account. List menu appears showing a list of the registered accounts in ascending order.

3 Press Δ or ∇ to select the ID of the account to be deleted.

4 Press [OK]. A list of selection options appears.

5 Press Δ or ∇ to select Delete and then press [OK]. A confirmation screen appears.

6 To proceed with deleting the account, press [Yes] ([Left Select]). Completed. appears and the account is deleted. The once deleting of the account ends, the Account. List screen reappears.

Pressing [No] ([Right Select]) returns to the list of selections options without deleting the account.

Apply Limit (Operation settings when limits are exceeded)

Use this to specify the action taken when a department exceeds its printing limits.

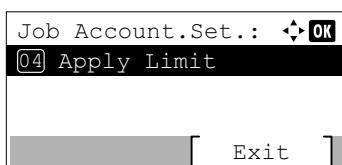
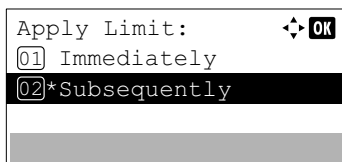

- 1** In the `Job Account.Set.` menu, press Δ or ∇ to select `Apply Limit`.
- 2** Press **[OK]**. The `Apply Limit` screen appears.
 - `Immediately` (prohibit printing from this job onwards)
 - `Subsequently` (prohibit printing from the next job onwards)
- 3** Press Δ or ∇ to select a setting and then press **[OK]**. The `Job Account.Set.` menu list reappears.

Unknown ID Job (Operation settings for unknown IDs)

This specifies the behavior for handling the jobs sent with unknown or unspent login user names or User ID. If the User Login is set to invalid and Job Accounting is set to valid, follow the procedure when the Account ID is unknown.

- 1 Press **[Menu]**.
- 2 Press Δ or ∇ to select `User/Job Account`.
- 3 Press **[OK]**. The Login screen appears.



Note When user login administration is set:

- When logged in as an administrator, the log in screen is not displayed and the `User/Job Account` menu screen is displayed.
- The setting is not possible when logged in as anyone other than an administrator. Log in again as an administrator.

- 4 With the `Login User Name` entry field selected, press **[OK]**. The `Login User Name` entry screen is displayed.

- 5 Enter the Login User Name using the numeric keys then press **[OK]**. The log in screen reappears.



Note The initial setting for the administrator's Login User Name is set as shown below.

ECOSYS P3045dn: 4500

ECOSYS P3050dn: 5000

ECOSYS P3055dn: 5500

ECOSYS P3060dn: 6000

For details on entering characters, refer to *Character Entry Method* on page A-2.

- 6 Press Δ or ∇ to select the `Login Password` entry field.

- 7 Press **[OK]**. The `Login Password` entry screen is displayed.

```

Login User Name:  [OK]
                  6000
Login Password:
                  *****
                  [Login]
  
```

- 8** Enter the Login Password using the numeric keys then press **[OK]**. The login screen reappears.



Note The initial setting for the administrator's Login Password is set as shown below.

ECOSYS P3045dn: 4500

ECOSYS P3050dn: 5000

ECOSYS P3055dn: 5500

ECOSYS P3060dn: 6000

For details on entering characters, refer to *Character Entry Method* on page A-2.

```

User/Job Account: [OK]
01 User Login Set.
02 Job Account.Set.
03 Unknown ID Job
                  [Exit]
  
```

- 9** Pressing **[Login]** (**[Right Select]**). If the entered Login User Name and Login Password are correct, the User/Job Account menu screen appears.

- 10** Press Δ or ∇ to select Unknown ID Job.

- 11** Press **[OK]**. The Unknown ID Job screen appears.

- Reject (Not printed)
- Permit (Printed)

```

Unknown ID Job:  [OK]
01 *Reject
02 Permit
  
```

- 12** Press Δ or ∇ to select a setting and then press **[OK]**. The User/Job Account menu list reappears.

Adjust/Maint. (Adjust/Maintenance selection/setting)

Adjust/Maintenance is used to adjust the print quality and to carry out printer maintenance.

The options available in Adjust/Maintenance are as follows:

- Quiet Mode (Setting the Quiet Mode)...4-150
- Restart (Restart Printer)...4-151
- Service Setting (for Maintenance)...4-152

IMPORTANT *Service Setting* is primarily a menu used by service personnel for maintenance work. There is no need for customers to use this menu.

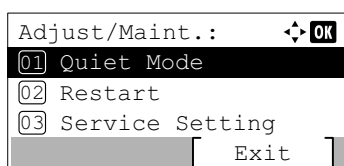

- 1 Press **[Menu]**.
- 2 Press Δ or ∇ to select *Adjust/Maint.*.
- 3 Press **[OK]**. The *Adjust/Maint.* menu appears showing a list of available options.

Quiet Mode (Setting the Quiet Mode)

Lower print speed for quiet processing.

Options available in Quiet Mode are as follows:

- Quiet Mode (Selecting the Quiet Mode)...4-150
- Each Job (Permission for settings for each jobs)...4-151

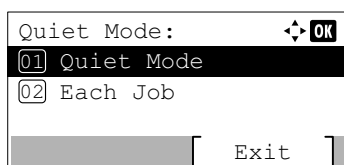

- 1 In the *Adjust/Maint.* menu screen, press Δ or ∇ to select *Quiet Mode*.
- 2 Press **[OK]**. The *Quiet Mode* menu appears showing a list of available options.

Quiet Mode (Selecting the Quiet Mode)

Set the Quiet Mode. Select this mode when the running noise is uncomfortable.



Note The processing speed will be slower than normal when in Quiet Mode.

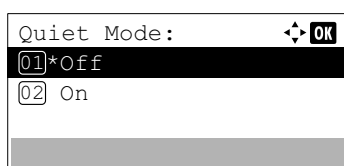

- 1 In the *Quiet Mode* menu screen, press Δ or ∇ to select *Quiet Mode*.
- 2 Press **[OK]**. The [*Quiet Mode*] menu appears.
- 3 Press Δ or ∇ to select *Off* or *On*.
- 4 Press **[OK]**. The Quiet Mode is set and the *Quiet Mode* menu screen reappears.

Each Job (Permission for settings for each jobs)

It is possible to set the use of Quiet Mode for each job. Set whether or not to permit the setting for each job.

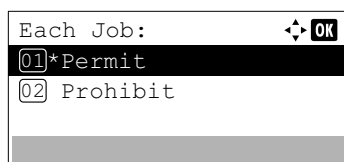

- 1 In the Quiet Mode menu screen, press Δ or ∇ to select Each Job.
- 2 Press [OK]. The Each Job menu appears.

- 3 Press Δ or ∇ to select Permit or Prohibit.
- 4 Press [OK]. The selected mode is set and the Quiet Mode menu screen reappears.

Restart (Restart Printer)

The procedure described below resets the printer's temporary conditions, such as the current page orientation, font, etc., set by commands to their default values. Downloaded fonts and macros are deleted from the printer's memory.

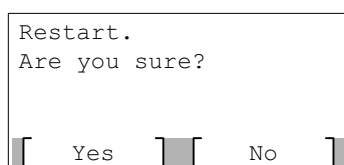

- 1 In the Adjust/Maint. menu screen, press Δ or ∇ to select Restart..
- 2 Press [OK]. A confirmation screen appears.
Press [Yes] ([Left Select]). The printer is restarted.
Pressing [No] ([Right Select]) returns to the Adjust/Maint. menu screen without restarting the printer.

Service Setting (for Maintenance)

IMPORTANT *Service Setting* is primarily a menu used by service personnel for maintenance work.

Item	Description	Value
Service Status	The service status page contains printer settings information that is more detailed than the standard status page and is therefore mostly for service purposes. However, there is a great deal of information on the service status page that may be useful to you.	Yes, No
Network Status	The network status page contains detailed information on the network settings. This is primarily used for maintenance by service personnel, but it contains information that may also be useful to you.	Yes, No
Op Netwk Status	The option network status page contains detailed information on the network settings. This is primarily used for maintenance by service personnel, but it contains information that may also be useful to you. Note The <i>Op Netwk Status</i> menu is only displayed when the optional Network Interface Kit (IB-50) or Wireless Network Interface Kit (IB-51) is installed.	Yes, No
Test Page	The test page is printed to check the effectiveness of printer adjustments. This is primarily used for maintenance by service personnel, but it contains information that may also be useful to you.	Yes, No
Maintenance	This specifies the setting for confirmation of replacement with the new Maintenance Kit (resets the total number of Maintenance Kit print images). This is primarily used for maintenance by service personnel. Note The Maintenance menu is displayed only when <i>Replace MK.</i> appears.	Yes, No
Drum Drum2	This sets the refresh mode for the drum. When the printing quality declines, refreshing the drum can restore the printing quality. This is primarily used for maintenance by service personnel. Note <i>Drum2</i> does not appear with ECOSYS P3045dn.	Yes, No
New Developer	This specifies the setting for confirmation of replacement with the new Developer (resets the total number of Developer print images). This is primarily used for maintenance by service personnel.	Yes, No
Auto DrumRefresh	An automatic drum refresh is sometimes carried out when the power supply is switched on or when the machine recovers from sleep mode. In order to maintain the image quality, the automatic drum refresh is implemented automatically after observing the surrounding temperature and humidity. Here, the time for carrying out the automatic drum refresh is set. Normally set it to <i>Standard</i> . If <i>Off</i> or <i>Short</i> is selected, the best image quality may not be kept.	Off, Short, Standard, Long
Drum Heater	This sets the <i>On/Off</i> of the drum heater integrated in the machine. When Drum Heater is set to <i>On</i> , the drum heater continues to start, but the drum refresh is not carried out. When the machine is installed in a high humidity environment, the start up time can be shortened. Note This setting does not appear in some regions.	Off, On
Write Data	This writes data to USB memory. Note This menu only appears when a USB memory device is inserted.	Yes, No

Item	Description	Value
Altitude Adj.	This sets the altitude adjustment mode. If you are using the machine at high altitude and print quality has deteriorated, you can use Altitude Adjustment mode to restore print quality.	Normal, 1001 - 2000m, 2001 - 3000m, 3001 - 3500m
MC	This sets the output of the main charger. When print quality has deteriorated, the output of the main charger can be changed to restore print quality.	1 - 7

Op Functions (Optional application settings)

You can use the optional applications installed on this machine.

Application

The applications listed below are installed on this machine.

- DATA SECURITY (Data Security Kit(E))
- ID Card (Card Authentication Kit(B))
- UG-33 (ThinPrint)

There are also some applications that can be used for a limited trial period.

 **Note** Restrictions such as the number of times the application can be used during the trial period differ depending on the application.

The options available in Op Functions menu are as follows:

- Starting Application Use...4-154
- Checking Application Details...4-156

Starting Application Use

Use the procedure below to start using an application.

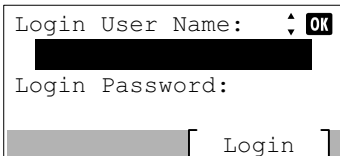
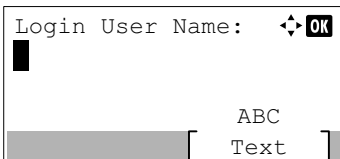
- 1 Press **[Menu]**.
- 2 Press Δ or ∇ to select **Op Functions**.
- 3 Press **[OK]**. The Login screen appears.



Note When user login administration is set:

- When logged in as an administrator, the log in screen is not displayed and the **Op Functions** menu screen is displayed.
- The setting is not possible when logged in as anyone other than an administrator. Log in again as an administrator.

- 4 With the **Login User Name** entry field selected, press **[OK]**. The **Login User Name** entry screen is displayed.

- 5 Enter the **Login User Name** using the numeric keys then press **[OK]**. The log in screen reappears.



Note The initial setting for the administrator's **Login User Name** is set as shown below.

ECOSYS P3045dn: 4500

ECOSYS P3050dn: 5000

ECOSYS P3055dn 5500

ECOSYS P3060dn: 6000.

For details on entering characters, refer to *Character Entry Method* on page A-2.

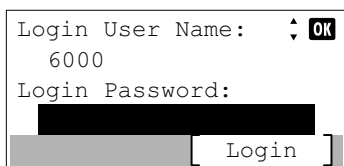

6 Press Δ or ∇ to select the Login Password entry field.

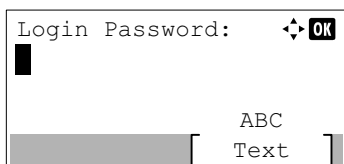

7 Press [OK]. The Login Password entry screen is displayed.

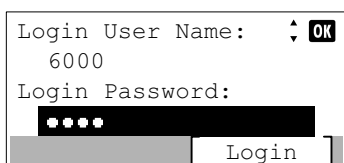

8 Enter the Login Password using the numeric keys then press [OK]. The login screen reappears.



Note The initial setting for the administrator's Login Password is set as shown below.

ECOSYS P3045dn: 4500

ECOSYS P3050dn: 5000

ECOSYS P3055dn: 5500

ECOSYS P3060dn: 6000.

For details on entering characters, refer to *Character Entry Method* on page A-2.

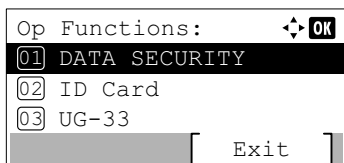

9 Pressing [Login] ([Right Select]). If the entered Login User Name and Login Password are correct, the Op Functions menu appears.

10 Press Δ or ∇ to select the desired application.

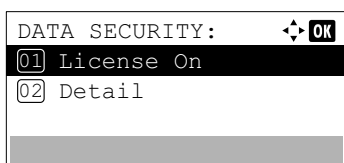

11 Press [OK].

12 Press Δ or ∇ to select License On.



Note You can view detailed information on the selected application by selecting Detail.

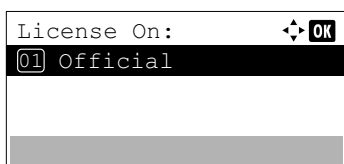

13 Press [OK].

14 Press Δ or ∇ to select Official.



Note There are also some applications that can be used for a limited trial period. To use the application as a trial, select Trial and press [OK]. The confirmation screen is displayed so press [Yes] ([Left Select]).

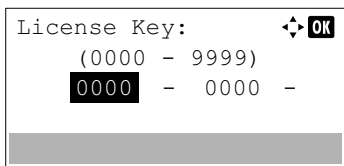

15 Press [OK].

16 Use the numeric keys or press Δ or ∇ to enter the license key. Use \triangleleft and \triangleright to move the position being entered, which is shown highlighted.



Note Some applications do not require you to enter a license key.

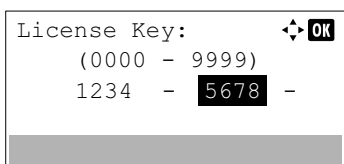

17 Press [OK].

18 When the confirmation screen appears, press [Yes] ([Left Select]).

IMPORTANT If you change the date/time while using an application, you will no longer be able to use the application.



Note If a message prompting a restart is displayed after changes have been made then obey the message and switch the machine OFF and ON again.

Checking Application Details

Use the procedure below to check the details of an application.

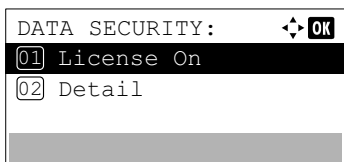

1 In the Op Functions menu, press Δ or ∇ to select the application to check the details of.

2 Press [OK].

3 Press Δ or ∇ to select Detail.

4 Press [OK]. You can now view detailed information on the selected application.

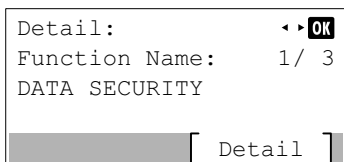

5 Document Box

This chapter contains explanations on the following topics:

Document Box	5-2
Custom Box	5-3
Job Box	5-21
Computer Settings (Printer Driver)	5-30

Document Box

The Document Box is a function for saving print data from a computer onto the memory on the machine and then printing it by operating the operation panel.

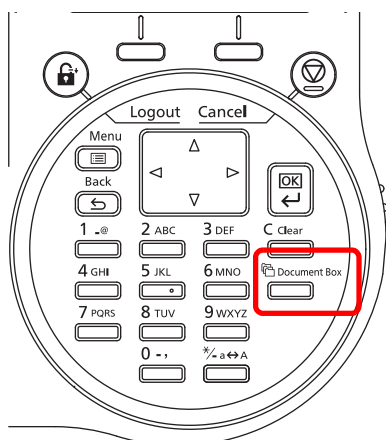

Press [**Document Box**] to display the Document Box menu.

Document Box has the following functions.

- Custom Box...5-3
- Job Box...5-21

Outline of Custom Box and Job Box

The outline of Custom Box and Job Box and the options required are as follows:

	Custom Box	Job Box
Primary function	This is a general-purpose box. Print data can be stored to the Custom Box and then re-used whenever necessary.	Job Box is a print function that makes the Job Retention function possible. Job Retention has four modes as summarized below. Quick Copy: To later print additional copies Proof-and-Hold: To proof the first copy before printing multiple copies Private Print: To hold the document in printer to prevent unauthorized access Stored Job: To electronically store documents such as fax cover pages
Start storing by	Printer driver	Printer driver
Adding more boxes	Yes (to a maximum of 1,000 boxes)	No
Password setting	Yes	Yes (possible in Private Print and Stored Job)
Data after printing	Stored	Stored except Private Print
Support for User Login Administration	Yes (The users can be set separately for each Box)	No
SSD installation	Available	Available
RAM disk use	Not available	Available (Only Proof-and-Hold and Private Print can be used)



Note For information on the optional SSD, refer to *About the Options on page A-5*.

For information on the RAM disk, refer to *RAM Disk Setting (Using the RAM disk) on page 4-100*.

For the formatting of the SSD, refer to *Format SSD (Formatting the SSD) on page 4-101*.

Custom Box

IMPORTANT To use a Custom Box, an optional SSD must be installed in the printer.

The SSD must be formatted from the printer. For more information, refer to *Format SSD (Formatting the SSD)* on page 4-101.

The Custom Box is a general-purpose box which allows the user to save print data on the printer's SSD and then re-use it whenever necessary.

The transmission of data to save in the box is done with the printer driver. For more information, refer to the *Printer Driver User Guide*.

Use the printer's operation panel to print the print data stored in a Custom Box.



Note The creation and setting of Custom Boxes is also possible from Command Center RX.

Procedure for printing using Custom Box

Follow the work flow below when using Custom Box.

Registering the Custom Box (page 5-4)



Specifying the Custom Box from a computer and sending the print job (page 5-30)



Using the operation panel to specify a file within a Box and printing it (page 5-13)

Operation panel display

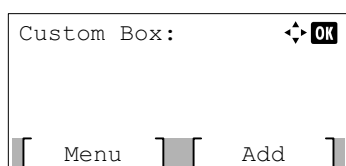

- 1 Press **[Document Box]**. Either the Custom Box list screen or the Job Box menu screen is displayed.



Note After pressing **[Document Box]**, it is possible to display either the Custom Box list screen or the Job Box menu screen or to set them. Refer to *Def. Screen(Box) (Document Box default screen setting)* on page 4-94.

If the Job Box menu screen is displayed, follow the procedure below to display the Custom Box list screen.

- 1 Press **[Back]**.
- 2 Press Δ or ∇ to select Custom Box.
- 3 Press **[OK]**. The Custom Box list screen appears.

The options available in Custom Box are as follows:

- Custom Box operation (Box creation, editing and deletion)...5-4
- File operations (Printing, deleting and moving files)...5-13

Custom Box operation (Box creation, editing and deletion)

It is possible to create Custom Boxes and change Box settings.

The following operations are possible:

- Custom Box creation...5-4
- Editing and Deleting Custom Boxes...5-10
- Sorting the Custom Box list...5-11
- Searching Custom Boxes...5-11
- Setting automatic document deletion for Custom Boxes...5-12

 **Note** The creation and setting of Custom Boxes is also possible from Command Center RX. For more information, refer to the *Command Center RX User Guide*.

Custom Box creation

Create a Custom Box. Enter the Box Name and Box Number then it is possible to continue on and set the details of the Box.

 **Note** When user login administration is enabled, log in as a user with administrator authority.

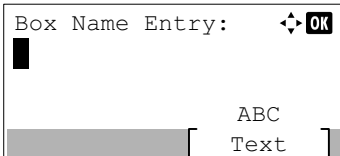

- 1 In the Custom Box list screen, press [Add] ([Right Select]). The Box Name Entry screen appears.

- 2 Enter the Box Name using the numeric keys.

 **Note** Up to 32 characters can be entered.
For details on entering characters, refer to *Character Entry Method* on page A-2.

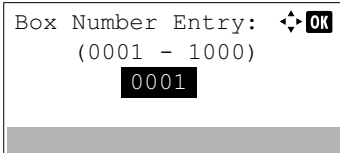

- 3 Press [OK]. The Box Number Entry screen appears.

- 4 Use the numeric keys or press Δ or ∇ to enter the Box Number.

 **Note** Enter the Box Number as a four-digit number from 0001 - 1000.

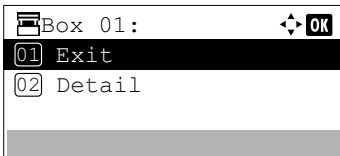

- 5 Press [OK].

- 6 Press Δ or ∇ to select Detail or Exit then press [OK].

To set the details of the Box, select Detail and proceed to *Detailed box settings* on page 5-5.

If the details of the Box will not be set then select Exit and finish the operation.

Detailed box settings

Set the details of the Box when necessary. The items to set are different between when user login administration is not enabled, when user login administration is enabled and the user is logged in with administrator authority and when user login administration is enabled and the user is logged in with user authority.

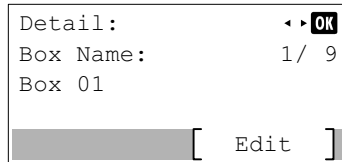

The detailed settings for the Box are as shown below.

Setting	User login Off	User login On		Reference Page
		Administrator	User	
Box Name	Yes	Yes	Yes	Box Name (Change the Box name)...5-5
Owner	–	Yes	No	Owner (Owner settings)...5-6
Permission	–	Yes	Yes	Permission (settings for the sharing of a Box)...5-6
Box Password	Yes	Yes	Yes	Box Password (Box password setting)...5-7
Box Number	Yes	Yes	Yes	Box number (Change of the Box number)...5-7
Usage Restrict.	Yes	Yes	No	Usage Restrict. (Setting for maximum possible capacity usage)...5-8
Auto File Del.	Yes	Yes	Yes	Auto File Del. (Setting for automatic file deletion)...5-8
Overwrite Set.	Yes	Yes	Yes	Overwrite Set. (Setting of overwrite storage)...5-9
Del. afterPrint	Yes	Yes	Yes	Del. afterPrint (Setting for file deletion after printing)...5-9

Yes: The setting can be changed.

No: The setting cannot be changed.

–: No setting

Box Name (Change the Box name)

Change the Box name.

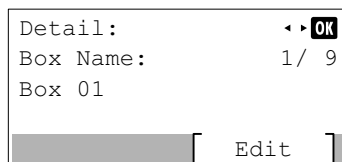

1 In the Detail menu screen, press ◀ or ▶ to select Box Name.

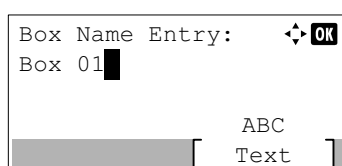

2 Press [Edit] ([Right Select]). The Box Name Entry screen appears.

- 3 Enter the Box Name using the numeric keys.



Note Up to 32 characters can be entered.

Refer to *Character Entry Method on page A-2* for details on entering characters.

- 4 Press [OK]. The `Detail` menu screen reappears.

Owner (Owner settings)

When user login administration is enabled, set the owner of the Box. If the owner is not set then the owner name is displayed as -----.

Detail: [OK]
 Owner: 2 / 9
 User 01
 [Change]

- 1 In the `Detail` menu screen, press ◀ or ▶ to select `Owner`.

User setting: [OK]
 [01] Network user
 [02] None

- 2 Press [Change] ([Right Select]). The `User setting` screen appears.

- 3 Press ▲ or ▼ to select `Network User`.



Note If the owner will not be set then select `None` and press [OK].

- 4 Press [OK]. The `Login User Name` screen appears.

Login User Name: [OK]
 [Domain] [Text]

- 5 Enter the Login User Name using the numeric keys.



Note Up to 64 characters can be entered.

Refer to *Character Entry Method on page A-2* for details on entering characters.

If the domain has been registered, [Domain] ([Left Select]) appears. Press [Domain] ([Left Select]), and press ▲ or ▼ to select the domain name.

- 6 Press [OK]. The `Detail` menu screen reappears.

Permission (settings for the sharing of a Box)

When user login administration is enabled, this setting determines whether or not a Box will be shared with other users. This setting is possible when `Network user` has been selected as the *Owner (Owner settings) on page 5-6*.

Detail: [OK]
 Permission: 3 / 9
 Shared
 [Change]

- 1 In the `Detail` menu screen, press ◀ or ▶ to select `Permission`.

2 Press [Change] ([Right Select]). The `Permission` screen appears.

3 Press Δ or ∇ to select `Shared` or `Private`.

4 Press [OK]. The `Detail` menu screen reappears.

Box Password (Box password setting)

It is possible to set a password for a box and restrict the users who have access to it. Enter one if necessary.

 **Note** This setting is not displayed when user login administration is enabled and the *Permission (settings for the sharing of a Box)* on page 5-6 has been set to `Private`.

1 In the `Detail` menu screen, press \triangleleft or \triangleright to select `Box Password`.

2 Press [Edit] ([Right Select]). The `New Password` entry screen appears.

3 Enter the new password using the numeric keys.

 **Note** Up to 16 characters can be entered. For details on entering characters, refer to *Character Entry Method* on page A-2.

4 Press [OK]. The `Confirm Password` entry screen appears.

5 To confirm, re-enter the password to be registered. Enter the password using the numeric keys.

6 Press [OK]. If the password is correct, the setting is changed to the new password and the `Detail` menu screen reappears.

If the password is not correct, the display shows `Incorrect password.` and returns to the `New Password` screen, so enter again from the new password.

Box number (Change of the Box number)

Change the Box number.

1 In the `Detail` menu screen, press \triangleleft or \triangleright to select `Box Number`.

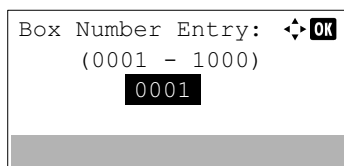

- 2 Press [Edit] ([Right Select]). The Box Name Entry screen appears.

- 3 Use the numeric keys or press Δ or ∇ to enter the Box Number.



Note Enter the Box Number as a four-digit number from 0001 - 1000.

If the display shows `This box number is already registered.`, this Box Number is already in use. Register a different Box Number.

- 4 Press [OK]. The Detail menu screen reappears.

Usage Restrict. (Setting for maximum possible capacity usage)

It is possible to restrict the capacity of Boxes. To limit the usage capacity, enter the maximum value (MB) using the numeric keys. The limit value will vary depending on the number of user Boxes that are created, but it is possible to enter the maximum between 1 and 30,000 (MB).

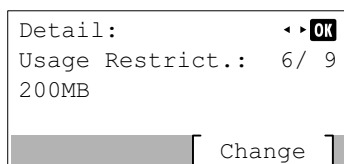

- 1 In the Detail menu screen, press \triangleleft or \triangleright to select Usage Restrict..

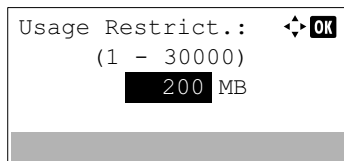

- 2 Press [Change] ([Right Select]). The Usage Restrict. screen appears.

- 3 Enter the limit value using the numeric keys, Δ or ∇ .

- 4 Press [OK]. The Detail menu screen reappears.

Auto File Del. (Setting for automatic file deletion)

This automatically deletes the documents that have been saved after a fixed period. Set to `On` for the automatic deletion and then enter the number of days that the documents will be stored. Between 1 and 31 (days) can be entered. Set to `Off` if automatic deletion will not be used.

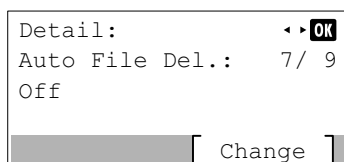

- 1 In the Detail menu screen, press \triangleleft or \triangleright to select Auto File Del..



- 2 Press [Change] ([Right Select]). The Auto File Del. menu screen appears.

- 3 Press Δ or ∇ to select `Off/On`.

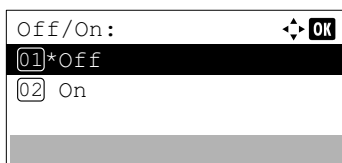

4 Press **[OK]**. The Off/On screen appears.



5 Press Δ or ∇ to select On or Off.

6 Press **[OK]**. The Auto File Del. menu screen reappears.



Note If On has been selected, set the number of days for storage as the Period. Period is only displayed if it has been set to On.

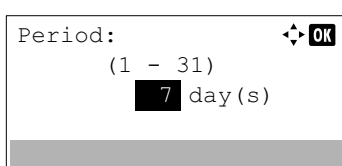

7 Press Δ or ∇ to select Period.

8 Press **[OK]**. The Period screen appears.

9 Enter the number of days for storage using the numeric keys, Δ or ∇ .

10 Press **[OK]**. The Detail menu screen reappears.

Overwrite Set. (Setting of overwrite storage)

This setting is used to permit or prohibit the overwriting of old documents that have been stored for the storage of new documents.

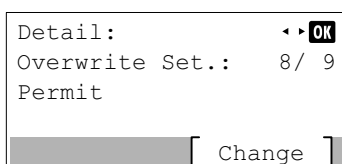

1 In the Detail menu screen, press \triangleleft or \triangleright to select Overwrite Set..

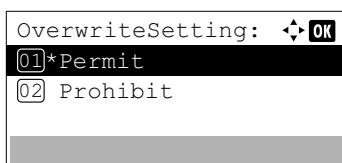

2 Press [Change] (**[Right Select]**). The Overwrite Set. screen appears.

3 Press Δ or ∇ to select Permit or Prohibit.

4 Press **[OK]**. The Detail menu screen reappears.

Del. afterPrint (Setting for file deletion after printing)

This automatically deletes the documents from the Boxes when the printing is complete.

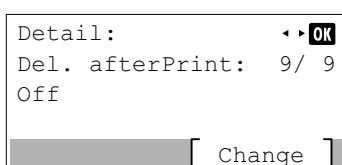

1 In the Detail menu screen, press \triangleleft or \triangleright to select Del. afterPrint.

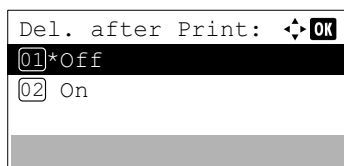

2 Press [Change] ([Right Select]). The Del. afterPrint screen appears.

3 Press Δ or ∇ to select On or Off.

4 Press [OK]. The Detail menu screen reappears.

Editing and Deleting Custom Boxes

It is possible to change the detailed settings of the Custom Boxes and to delete Boxes.

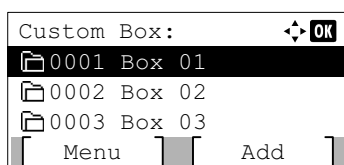

1 In the Custom Box list screen, press Δ or ∇ to select the Box to edit or delete.

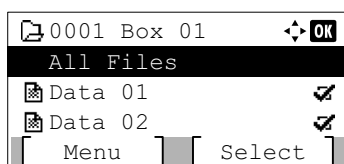

2 Press [OK]. The file list screen for the Box selected is displayed.



Note If the screen for entering a password is displayed then enter the password using the numeric keys and then press [OK].

Refer to *Character Entry Method* on page A-2 for details on entering characters.

The following operations are possible:

- Editing Custom Boxes...5-10
- Deleting Custom Boxes...5-11

Editing Custom Boxes

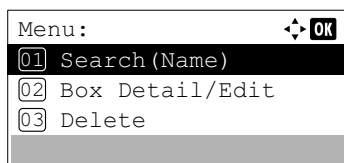

1 In the file list screen, press [Menu] ([Left Select]). The Menu screen appears.

2 Press Δ or ∇ to select Box Detail/Edit.

3 Press [OK]. The Detail screen appears.

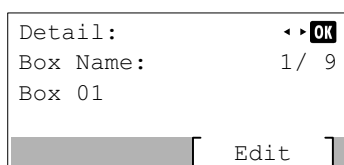

4 Press \triangleleft or \triangleright to check each of the settings and make changes.



Note For the method for making changes, refer to *Detailed box settings* on page 5-5.

5 When the editing is completed press [OK]. The file list screen reappears.

Deleting Custom Boxes

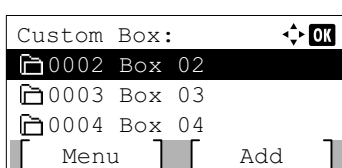
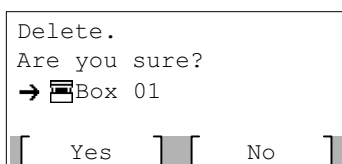
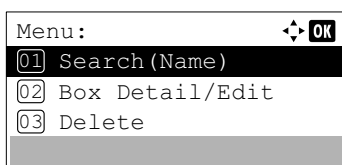

1 In the file list screen, press [Menu] (**[Left Select]**). The Menu screen appears.

2 Press Δ or ∇ to select Delete.

3 Press [OK]. A confirmation screen appears.

4 To proceed with deleting the custom box, press [Yes] (**[Left Select]**). Completed. appears and the custom box is deleted. The once deleting of the custom box ends, the Custom Box list screen reappears.

Pressing [No] (**[Right Select]**) returns to the file list screen without deleting the custom box.

Sorting the Custom Box list

When user login administration is enabled, it is possible to sort the list display into either Box Number order or Box Owner order.

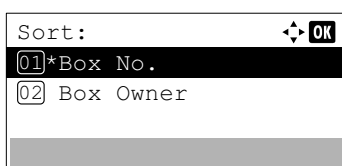
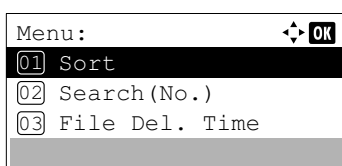

1 In the Custom Box list screen, press [Menu] (**[Left Select]**). The Menu screen appears.

2 Press Δ or ∇ to select Sort.

3 Press [OK]. The Sort screen appears.

4 Press Δ or ∇ to select Box No. or Box Owner.

5 Press [OK]. The Menu screen reappears.

Searching Custom Boxes

It is possible to search for a Custom Box using either the Box number or Box name.

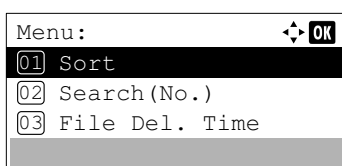

1 In the Custom Box list screen, press [Menu] (**[Left Select]**). The Menu screen appears.

2 Press Δ or ∇ to select Search (No.) or Search (Name).

Searching with Box numbers

Searching with Box names

- Press **[OK]**. The *Search (No.)* screen or the *Search (Name)* screen appears.

Searching is possible using the methods below:

- Searching with Box numbers...5-12
- Searching with Box names...5-12

- In the *Search (No.)*, press **[Menu]** (**[Left Select]**). The *Menu* screen appears.

- Press Δ or ∇ to select *Search (No.)*.

- Press **[OK]**. The *Search (No.)* screen appears.

- Enter the Box number to be found and press **[OK]**. A search is done for the Box number entered.

- In the *Search (No.)*, press **[Menu]** (**[Left Select]**). The *Menu* screen appears.

- Press Δ or ∇ to select *Search (Name)*.

- Press **[OK]**. The *Search (Name)* screen appears.

- Enter the Box name to be found and press **[OK]**. A search is done for the Box name entered.



Note Refer to *Character Entry Method* on page A-2 for details on entering characters.

Setting automatic document deletion for Custom Boxes

Set the time for documents stored in Custom Boxes to be automatically deleted.

- In the *Custom Box* list screen, press **[Menu]** (**[Left Select]**). The *Menu* screen appears.

- Press Δ or ∇ to select *File Del. Time*.

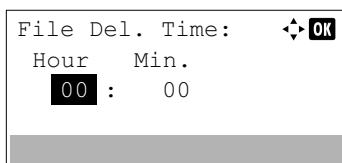

3 Press **[OK]**. The File Del. Time screen appears.

4 Use the numeric keys or press Δ or ∇ to enter the hours and minutes.

Press Δ or ∇ to increase or decrease the figures.

Use \triangleleft and \triangleright to move the position being entered, which is shown highlighted.

5 Press **[OK]**. The Menu screen reappears.

File operations (Printing, deleting and moving files)

It is possible to print files stored in a Custom Box, to delete them or to move them to a different Custom Box.

The following operations are possible:

- Box number/Box name (Select a File)...5-13
- Select/Deselect All Files...5-14
- Print a File...5-14
- Print a File (Changes to the print settings)...5-15
- Delete a File...5-19
- Moving files...5-19
- Check File Details...5-20

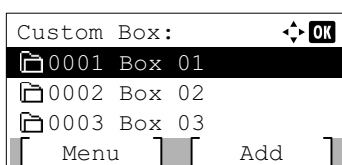

1 In the Custom Box list screen, press Δ or ∇ to select a Custom Box.

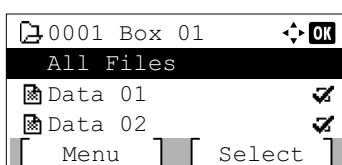

2 Press **[OK]**. The printer displays a list of files stored in the Custom Box.



Note If the screen for entering a password is displayed then enter the password using the numeric keys and then press **[OK]**.

Refer to *Character Entry Method* on page A-2 for details on entering characters.

Box number/Box name (Select a File)

To print/delete a file in the Custom Box, first select the file to be printed or deleted.

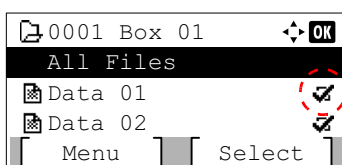

1 Press Δ or ∇ to select the file to be printed/deleted.

2 When **[Select]** (**[Right Select]**) is pressed, the file is selected. A checkmark will be placed on the right of the selected file.

Select the checkmarked file and press **[Select]** (**[Right Select]**) again to cancel the selection.



Note To select all files, follow the steps of *Select/Deselect All Files* on page 5-14.

Select/Deselect All Files

All files in the Custom Box are selected.

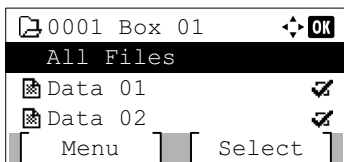

1 In the file list screen, press Δ or ∇ to select All Files.

2 Press [Select] (**[Right Select]**).

When there is a file not checked in the Custom Box, all files will be checkmarked.

When all files in the Custom Box are checked, all checkmarked files are deselected.

Print a File

Print the file(s) selected in the Custom Box.

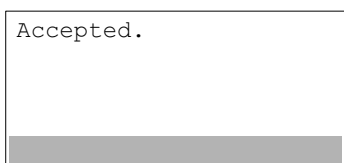
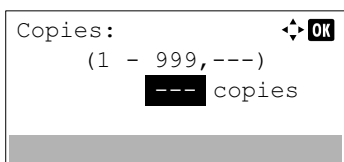
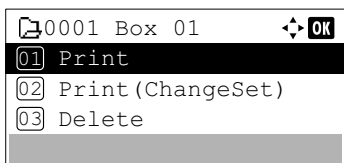

1 In the file list screen, select the item and press **[OK]**. The Print/Delete menu screen appears.

2 Press Δ or ∇ to select Print.

3 Press **[OK]**. The Copies menu screen appears.

If you want to change the number of remaining copies to be printed, use the numeric keys or press Δ or ∇ to set the number of copies to be printed.

 **Note** If Job Accounting is enabled, enter the account ID in the login screen that appears. The Copies menu screen appears after login.

--- is displayed first, and it means it according to the set number of copies when the data of each file is preserved. In this setting, each set number of copies is printed.

4 Press **[OK]**. The message Accepted. appears and printing begins. When On is selected in the *Del. afterPrint (Setting for file deletion after printing)* on page 5-9, the selected file will be deleted from the Custom Box after it is printed.

Print a File (Changes to the print settings)

To change the print settings for a file selected in a Custom Box and print it.

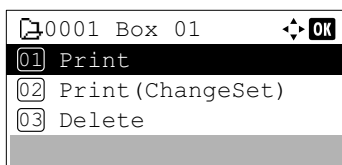

- 1 In the file list screen, select the item and press **[OK]**. The **Print/Delete** menu screen appears.

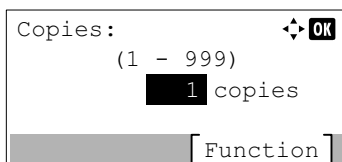

- 2 Press Δ or ∇ to select **Print (ChangeSet)**.
- 3 Press **[OK]**. The **Copies** menu screen appears.



Note If Job Accounting is enabled, enter the account ID in the login screen that appears. The **Copies** menu screen appears after login.

[Function] ([Right Select]) can be pressed to change the print settings. For details, refer to *Print Function Settings* on page 5-15.

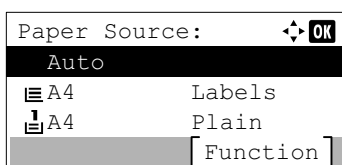

- 4 Press **[OK]**. The **Paper Source** menu screen appears.

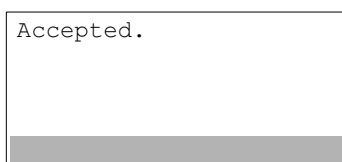

- 5 Press Δ or ∇ to select the tray containing the paper you want to use.
- 6 Press **[OK]**. The message **Accepted.** appears and printing begins. When **On** is selected in the *Del. afterPrint (Setting for file deletion after printing)* on page 5-9, the selected file will be deleted from the Custom Box after it is printed.

Print Function Settings

When printing, the print settings can be changed.

Options available in Print Function Settings are as follows:

- Quiet Mode (Selecting the Quiet Mode)...5-16
- Duplex (Setting the duplex printing)...5-16
- EcoPrint (Selecting the EcoPrint mode)...5-17
- File Name Entry (entering a file name)...5-17
- JobFinish Notice (Settings for notification when jobs are finished)...5-18
- Del. after Print (Delete data after printing setting)...5-18

Quiet Mode (Selecting the Quiet Mode)

Lower print speed for quiet processing. Select this mode when the running noise is uncomfortable. For details, refer to *Quiet Mode (Setting the Quiet Mode) on page 4-150*.

 **Note** The processing speed will be slower than normal when in Quiet Mode.
This cannot be used when `Prohibit` is set for *Each Job (Permission for settings for each jobs) on page 4-151*.

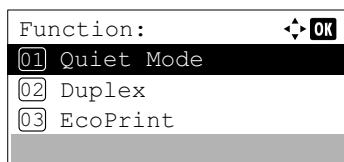

1 In the `Copies` menu or the `Paper Source` menu, press [Function] ([Right Select]). The `Function` menu appears.

2 Press Δ or ∇ to select `Quiet Mode`.

3 Press [OK]. The `Quiet Mode` screen appears.

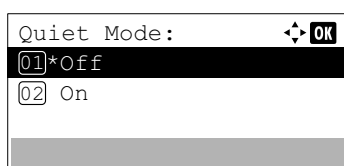

4 Press Δ or ∇ to select `On` or `Off`.

5 Press [OK]. The `Quiet Mode` is set and the `Function` menu reappears.

Duplex (Setting the duplex printing)

Set duplex printing. For details, refer to *Duplex (Setting the duplex printing) on page 4-46*.

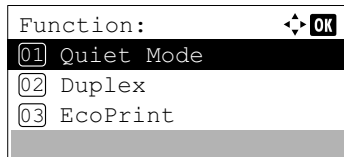

1 In the `Copies` menu or the `Paper Source` menu, press [Function] ([Right Select]). The `Function` menu appears.

2 Press Δ or ∇ to select `Duplex`.

3 Press [OK]. The `Duplex` screen appears showing the list of available duplex printing modes.

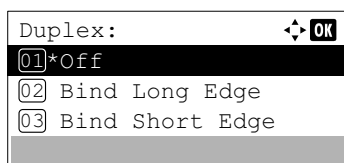

4 Press Δ or ∇ to select the desired duplex printing mode.

The message display toggles through the following:

Off

Bind Long Edge

Bind Short Edge

Selecting `Off` disables duplex printing.

5 Press [OK]. The duplex printing mode is set and the `Function` menu reappears.

EcoPrint (Selecting the EcoPrint mode)

Set EcoPrint mode. For details, refer to *EcoPrint (Selecting the EcoPrint mode)* on page 4-53.

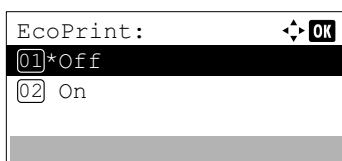
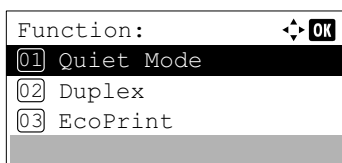

- 1 In the **Copies** menu or the **Paper Source** menu, press [Function] (**[Right Select]**). The **Function** menu appears.
- 2 Press Δ or ∇ to select **EcoPrint**.
- 3 Press **[OK]**. The **EcoPrint** screen appears.
- 4 Press Δ or ∇ to select the **EcoPrint** mode.
- 5 Press **[OK]**. The **EcoPrint** mode is set and the **Function** menu reappears.

File Name Entry (entering a file name)

Enter the file name. The file name entered is displayed as the Job Name in the Job Status and Job Log.

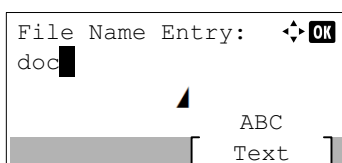
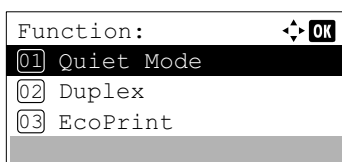

- 1 In the **Copies** menu or the **Paper Source** menu, press [Function] (**[Right Select]**). The **Function** menu appears.
- 2 Press Δ or ∇ to select **File Name Entry**.
- 3 Press **[OK]**. The **File Name Entry** screen appears.

- 4 Enter the file name using the numeric keys.



Note Up to 32 characters can be entered.

Refer to *Character Entry Method* on page A-2 for details on entering characters.

- 5 Press **[OK]**. The **Additional Info.** screen appears.

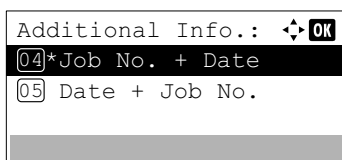

- 6 Press Δ or ∇ to select from the additional information that can be set for the file name.

The following settings can be selected.

- None (No additional information is added.)
- Date (To add the date.)
- Job No. (To add the Job Number.)
- Job No. + Date (To add the Job Number and date.)
- Date + Job No. (To add the date and Job Number.)

- Press **[OK]**. Register the file name and the `Function` menu reappears.

JobFinish Notice (Settings for notification when jobs are finished)

The end of a job is notified using E-mail.

 **Note** To send E-mail on this machine, set the SMTP setting to `On`. For details, refer to *Protocol/Settings (Detailed settings for the network protocol)* on page 4-78.

A mail server must be registered. For the method for setting a server, refer to the *Command Center RX User Guide*.

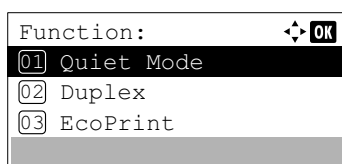

- In the `Copies` menu or the `Paper Source` menu, press `[Function]` (**[Right Select]**). The `Function` menu appears.

- Press Δ or ∇ to select `JobFinish Notice`.

- Press **[OK]**. The `JobFinish Notice` screen appears.

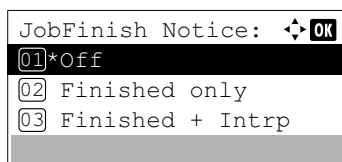

- Press Δ or ∇ to select the condition for notification.

The following settings can be selected.

`Off` (no notification)

`Finished only` (notification only when job finishes)

`Finished + Intrap`

(Notification when job finishes or is interrupted)

- Press **[OK]**. The `Address Entry` screen appears.

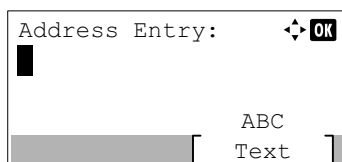

- Enter the E-Mail address to be notified.



Note Up to 128 characters can be entered.

Refer to *Character Entry Method* on page A-2 for details on entering characters.

When user login administration is set, the address of the logged in user is entered.

- Press **[OK]**. Register the address and the `Function` menu reappears.

Del. after Print (Delete data after printing setting)

Use this setting to specify whether or not the file data is deleted after printing.

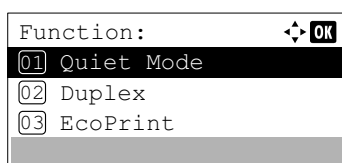

- In the `Copies` menu or the `Paper Source` menu, press `[Function]` (**[Right Select]**). The `Function` menu appears.

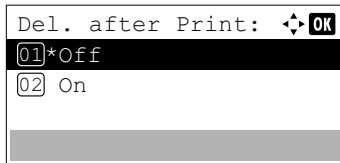

- 2 Press Δ or ∇ to select Del. after Print.
- 3 Press [OK]. The Del. after Print screen appears.

- 4 Press Δ or ∇ to select the Del. after Print setting.
- 5 Press [OK]. The Del. after Print setting is set and the Function menu reappears.

Delete a File

Delete the file(s) selected in the Custom Box.

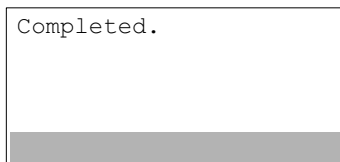
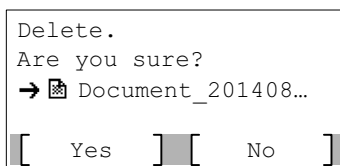
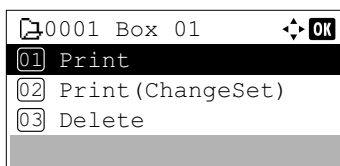

- 1 In the file list screen, select the item and press [OK]. The Print/Delete menu screen appears.

- 2 Press Δ or ∇ to select Delete.
- 3 Press [OK]. A confirmation screen appears.

- 4 Press [Yes] ([Left Select]). The message Completed. appears and the selected file(s) are deleted.
Pressing [No] ([Right Select]) returns to the file list menu screen without deleting the file.

Moving files

A file can be moved to a different Custom Box.

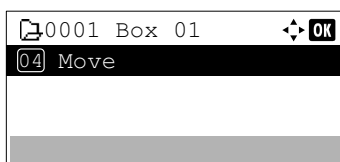
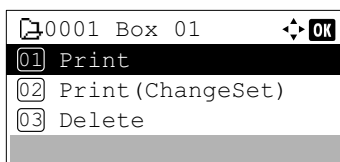

- 1 In the file list screen, select the item and press [OK]. The Print/Delete menu screen appears.

- 2 Press Δ or ∇ to select Move.

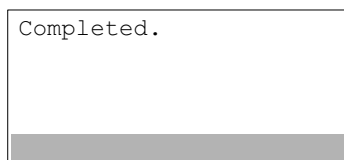
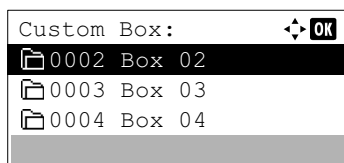

3 Press **[OK]**. The Custom Box list screen appears.

4 Press Δ or ∇ to select the destination Box.

5 Press **[OK]**. The message Completed. appears and the selected file(s) is/are moved.



Note If the screen for entering a password is displayed then enter the password using the numeric keys and then press **[OK]**.

Refer to *Character Entry Method* on page A-2 for details on entering characters.

Check File Details

Details for the file that is selected with the cursor will appear.

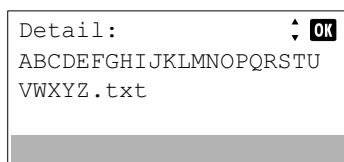
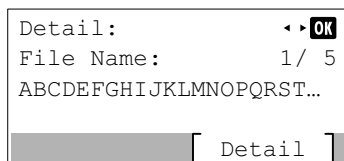
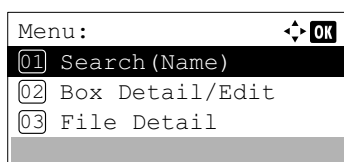

1 In the file list screen, select the file and press [Menu] (**[Left Select]**).

2 Press Δ or ∇ to select File Detail.

3 Press **[OK]**. Details for the file that is selected with the cursor appears.

The details for the file cover 5 pages in all. Press \triangleright to view to the next page or \triangleleft to return to the previous page.

In the File Name screen, if the file name is abbreviated because it cannot be displayed on one line, press [Detail] (**[Right Select]**) to change the display to three lines.

Job Box

IMPORTANT To use the Job Box, an optional SSD must be installed in the printer. The RAM disk may also be used in the Proof-and-Hold and Private Print modes.

Job Box is a print function that makes the Job Retention function possible. The settings are specified from the printer driver. Refer to *Computer Settings (Printer Driver)* on page 5-30 or the *Printer Driver User Guide*.



Note When using the RAM disk to use Job Box, set the RAM disk mode to On..

Job Retention

Job Retention has four modes as summarized below. These modes are selected from the printer driver through the application software:

	Quick Copy	Proof-and-Hold	Private Print	Stored Job
Primary function	To later print additional copies	To proof the first copy before printing multiple copies	To hold the document in printer to prevent unauthorized access	To electronically store documents such as fax cover pages
Start storing by	Printer driver	Printer driver	Printer driver	Printer driver
On terminating print setting from application software	Prints simultaneously	Prints one copy simultaneously	Does not print	Does not print
Retrieved by	Operation panel	Operation panel	Operation panel	Operation panel
Default number of copies printed at retrieval	Same as storing (can be changed)	One less (can be changed)	Same as storing (can be changed)	One (can be changed)
Maximum number of jobs stored †	300	300	Depends on the SSD capacity (the job is automatically deleted after printing)	Depends on the SSD capacity
PIN security	No	No	Yes	Yes (if necessary)
Data after printing	Stored	Stored	Deleted	Stored
Data at power off	Deleted	Deleted	Deleted	Stored
SSD	Necessary	Unnecessary (RAM disk may also be used)	Unnecessary (RAM disk may also be used)	Necessary

† Jobs in excess will cause the earlier ones to be deleted.



Note Refer to the *Printer Driver User Guide* for the driver settings and print (save) procedures.

Procedure for printing using Job Box

Follow the work flow below when using Job Box.

Specifying the Job Box from a computer and sending the print job (*page 5-30*)



Using the operation panel to specify a file within a Box and printing it

- Quick Copy (*page 5-22*)
- Proof-and-Hold (*page 5-22*)
- Private Print (*page 5-25*)
- Stored Job (*page 5-25*)

Operation panel display

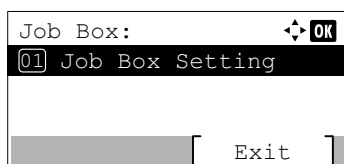

- 1 Press **[Document Box]**. Either the Custom Box list screen or the Job Box menu screen is displayed.



Note After pressing **[Document Box]**, it is possible to display either the Custom Box list screen or the Job Box menu screen or to set them. Refer to *Def. Screen(Box) (Document Box default screen setting)* on *page 4-94*.

If the Custom Box list screen is displayed, follow the procedure below to display the Job Box menu screen.

- 1 Press **[Back]**.
- 2 Press Δ or ∇ to select Job Box.
- 3 Press **[OK]**. The Job Box menu screen appears.

The options available in Job Box are as follows:

- Quick Copy (Using Quick Copy/Proof-and-Hold)...5-22
- Private/Stored (Printing a Private Print/Stored Job)...5-25
- Job Box Setting (Job Box Configuration)...5-28

Quick Copy is displayed if there are any jobs that were saved to the SSD in Quick Copy mode.

Quick Copy is also displayed if there are any jobs that were saved to SSD or RAM disk in Proof-and-Hold mode.

Private/Stored is only displayed if there are any jobs that were saved to the SSD or RAM disk.

Quick Copy (Using Quick Copy/Proof-and-Hold)

Quick Copy mode enables you to print the requested number of copies of a job, simultaneously storing the job on the SSD. When additional copies are required, you can reprint the required number of copies from the printer operation panel.

The default number of print jobs that can be stored on the SSD is 32. This value can be increased to up to 300. For details, refer to *Job Box Setting (Job Box Configuration)* on *page 5-28*. When the number of jobs reaches the limit, the oldest job will be overwritten by the new one.

When you print multiple copies, Proof-and Hold mode first prints one copy so that you can proof it before continuing to print the remaining copies. Since you can proof the printouts before printing the remaining copies, wastage of paper can be reduced. The printer prints one copy and, at the same time, saves the print job on the SSD or RAM disk. You can also change the number of copies when resuming printing from the operation panel.

When the printer is turned off, all stored jobs will be deleted.

 **Note** When a print job is stored in a Job Box for proof-and-hold, the power consumption is more than that of the sleep mode.

Refer to the *Printer Driver User Guide* for the driver settings.

The following operations are possible:

- Printing Additional Copies using Quick Copy/Remaining Copies of a Proof-and-Hold Job...5-23
- Select/Deselect All Files...5-23
- Print a File...5-24
- Deleting a Quick Copy/Proof-and-Hold Job...5-24
- Delete a File...5-25

Printing Additional Copies using Quick Copy/Remaining Copies of a Proof-and-Hold Job

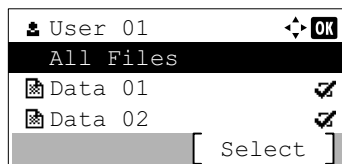
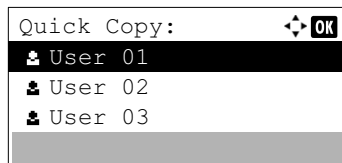

- 1 In the Job Box menu, press Δ or ∇ to select Quick Copy.
- 2 Press [OK]. The Quick Copy screen appears listing the user names for stored jobs.
- 3 Press Δ or ∇ to select the user name you entered in the printer driver.
- 4 Press [OK]. The printer displays a list of the jobs stored under the selected user name.

- 5 Press Δ or ∇ to scroll to the desired job title.

When [Select] (**[Right Select]**) is pressed, the file is selected. A checkmark will be placed on the right of the selected file.

Select the checkmarked file and press [Select] (**[Right Select]**) again to cancel the selection.



Note To select all files, follow the steps of *Select/Deselect All Files* on page 5-23

Select/Deselect All Files

All files in the Job Box are selected.

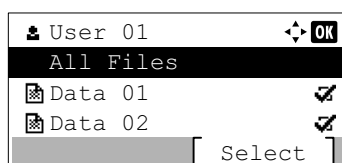
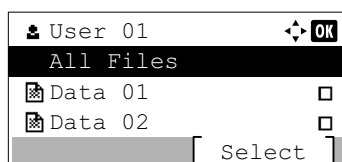
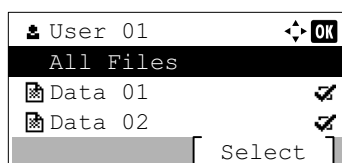

- 1 In the file list screen, press Δ or ∇ to select All Files.

- 2 Press [Select] (**[Right Select]**).

When all files in the Job Box are checked, all checkmarked files are deselected.

When there is a file not checked in the Job Box, all files will be checkmarked.

Print a File

Print the file(s) selected in the Job Box.

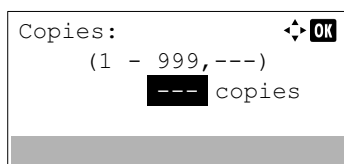
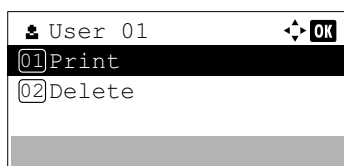

- 1 In the file list screen, select the item and press **[OK]**. The *Print/Delete* menu screen appears.
- 2 Press Δ or ∇ to select *Print* and press **[OK]**. The *Copies* menu screen appears.
To print 2 or more copies, use the numeric keys or press Δ or ∇ to set the number of copies to be printed.
 **Note** --- is displayed first, and it means it according to the set number of copies when the data of each file is preserved. In this setting, each set number of copies is printed.
- 3 Press **[OK]**. The message *Accepted.* appears and the printer prints the selected job.

Deleting a Quick Copy/Proof-and-Hold Job

Jobs saved using Quick Copy and Proof-and-Hold are automatically deleted when you turn the printer off, but you can also use this procedure to delete jobs individually.

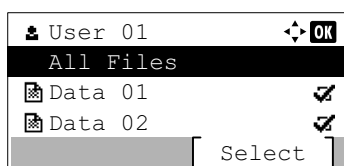
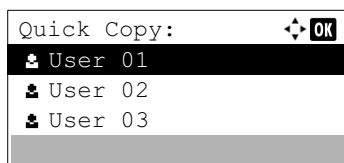

- 1 In the *Job Box* menu, press Δ or ∇ to select *Quick Copy*.
- 2 Press **[OK]**. The *Quick Copy* screen appears listing the user names for stored jobs.
- 3 Press Δ or ∇ to select the user name you entered in the printer driver.
- 4 Press **[OK]**. The printer displays a list of the jobs stored under the selected user name.
- 5 Press Δ or ∇ to select the name of the job to be deleted.
When **[Select]** (**[Right Select]**) is pressed, the file is selected. A checkmark will be placed on the right of the selected file.
Select the checkmarked file and press **[Select]** (**[Right Select]**) again to cancel the selection.

 **Note** To select all files, follow the steps of *Select/Deselect All Files* on page 5-23

Delete a File

Delete the file(s) selected in the Job Box.

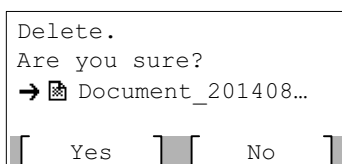
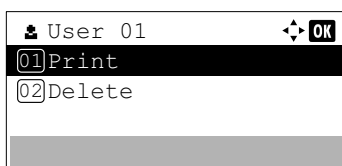

- 1 In the file list screen, select the item and press **[OK]**. The **Print/Delete** menu screen appears.
- 2 Press **△** or **▽** to select **Delete** and press **[OK]**. A confirmation message is appears.
- 3 Press **[Yes]** (**[Left Select]**). The message **Completed.** appears and the printer deletes the selected job. Pressing **[No]** (**[Right Select]**) returns to the file list screen.

Private/Stored (Printing a Private Print/Stored Job)

In private printing, you can specify that a job is not printed until you release the job from the operation panel. When sending the job from the application software, specify a 4-digit access code in the printer driver. The job is released for printing by entering the access code on the operation panel ensuring confidentiality of the print job.

In the stored job mode, access codes are not mandatory, but can be set on the printer driver. Then, the access code must be entered on the operation panel to print a stored job. Print data will be stored in the SSD or RAM disk after printing.



Note When a print job is stored in a Job Box for private print, the power consumption is more than that of the sleep mode.

Refer to the *Printer Driver User Guide* for the driver settings.

The following operations are possible:

- Printing a Private/Stored Job...5-25
- Print a File...5-26
- Deleting a Private/Stored Job...5-27
- Delete a File...5-27

Printing a Private/Stored Job

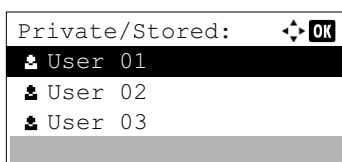

- 1 In the **Job Box** menu, press **△** or **▽** to select **Private/Stored**.
- 2 Press **[OK]**. The **Private/Stored** screen appears listing the user names for stored jobs.
- 3 Press **△** or **▽** to select the user name you entered in the printer driver.

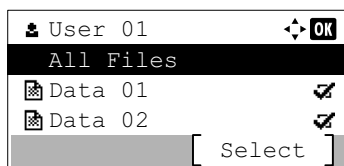

- 4 Press **[OK]**. The printer displays a list of the jobs stored under the selected user name.

- 5 Press Δ or ∇ to select the name of the job to be printed.

When **[Select]** (**[Right Select]**) is pressed, the file is selected. A checkmark will be placed on the right of the selected file.

Select the checkmarked file and press **[Select]** (**[Right Select]**) again to cancel the selection.



Note To select all files, follow the steps of *Select/Deselect All Files* on page 5-23

Print a File

Print the file(s) selected in the Job Box.

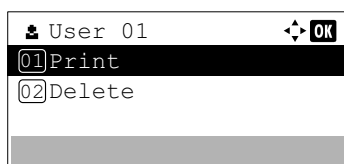

- 1 In the file list screen, select the item and press **[OK]**. The *Print/Delete* menu screen appears.

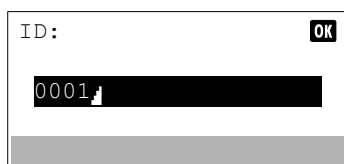

- 2 Press Δ or ∇ to select *Print* and press **[OK]**. If the selected job was saved as a Private Print job, its *ID* is displayed. If the job was saved in stored job mode, the number of direct copies is displayed.

- 3 Use the numeric keys to enter the access code entered in the printer driver.

Press **[OK]**. If the entered access code is correct, the *Copies* menu screen appears.

If the entered access code is incorrect, the *ID* menu screen reappears.



Note When the access code is set to the document selected in the check box, *Incorrect ID* is displayed for the disagreement.

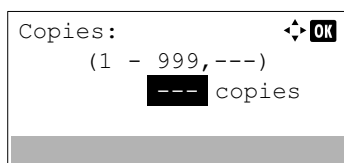

- 4 To print 2 or more copies, use the numeric keys or press Δ or ∇ to set the number of copies to be printed.

After selecting the multiple copies in the printer driver, you can also restore to "1" from the operation panel using the same method.



Note --- is displayed first, and it means it according to the set number of copies when the data of each file is preserved. In this setting, each set number of copies is printed.

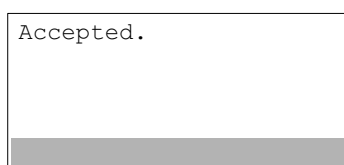

- 5 Press **[OK]**. The message *Accepted.* appears and the printer prints the selected job.

Deleting a Private/Stored Job

You can individually delete stored jobs by performing the following procedure. Jobs saved using Private Print will be automatically deleted when you turn the power off, or after printing, but jobs saved using Stored Job will not be deleted automatically.

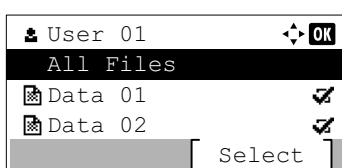
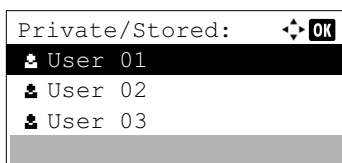

- 1 In the Job Box menu, press Δ or ∇ to select Private/Stored.
- 2 Press [OK]. The Private/Stored screen appears listing the user names for stored jobs.

- 3 Press Δ or ∇ to select the user name you entered in the printer driver.
- 4 Press [OK]. The printer displays a list of the jobs stored under the selected user name.

- 5 Press Δ or ∇ to select the name of the job to be deleted.
When [Select] ([Right Select]) is pressed, the file is selected. A checkmark will be placed on the right of the selected file.
Select the checkmarked file and press [Select] ([Right Select]) again to cancel the selection.

 **Note** To select all files, follow the steps of *Select/Deselect All Files* on page 5-23

Delete a File

Delete the file(s) selected in the Job Box.

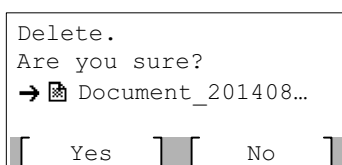
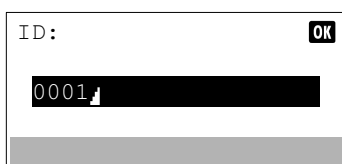
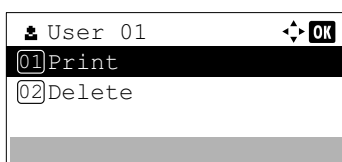

- 1 In the file list screen, select the item and press [OK]. The Print/Delete menu screen appears.

- 2 Press Δ or ∇ to select Delete and press [OK]. The ID is displayed.

- 3 Use the numeric keys to enter the access code entered in the printer driver.

- 4 Press [Enter] ([Right Select]). If the entered access code is correct, the Delete menu screen appears. If the entered access code is incorrect, the ID menu screen reappears.

 **Note** When the access code is set to the document selected in the check box, ID error is displayed for the disagreement.



- 5 Press [Yes] (**[Left Select]**). Complete. appears and the printer deletes the selected job.
Pressing [No] (**[Right Select]**) returns to the file list screen.

Job Box Setting (Job Box Configuration)

Change Job Box setting, such as the maximum number of storable documents in the Document Box, and automatic delete settings, and select the storage media.

The following items are available in the Job Box setting.

- Quick Copy Jobs (Changing the Maximum Number of Quick Copy jobs)...5-28
- JobRet. Deletion (Set Automatic Delete times for Temporary Jobs)...5-28
- Storage Media (Selecting the storage media for the jobs)...5-29

Quick Copy Jobs (Changing the Maximum Number of Quick Copy jobs)

This changes maximum number of Quick Copy jobs to a value between 0 and 300.

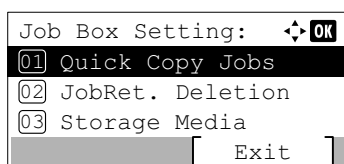

- 1 In the Job Box menu, press Δ or ∇ to select Job Box Setting.
- 2 Press **[OK]**. The Job Box Setting screen appears.

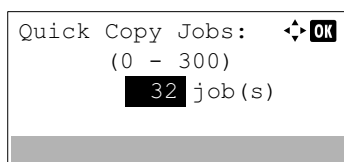

- 3 Press Δ or ∇ to select Quick Copy Jobs and press **[OK]**. The Quick Copy Jobs screen appears.
- 4 Use the numeric keys or Δ or ∇ to set the maximum number of Quick Copy jobs.
- 5 Press **[OK]**. The setting is stored and the Job Box Setting menu reappears.

JobRet. Deletion (Set Automatic Delete times for Temporary Jobs)

When the set period passes, the temporary jobs are automatically deleted.

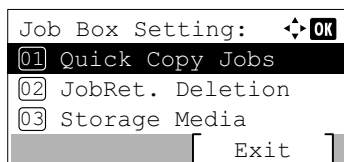

- 1 In the Job Box menu, press Δ or ∇ to select Job Box Setting.
- 2 Press **[OK]**. The Job Box Setting screen appears.
- 3 Press Δ or ∇ to select JobRet. Deletion and press **[OK]**. The JobRet. Deletion screen appears.

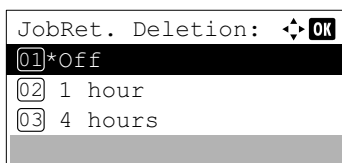

- 4 Press Δ or ∇ to select the desired Automatic Delete time. The list shows the following times:
 - Off (automatic delete is not performed)
 - 1 hour (deleted in 1 hour)
 - 4 hours (deleted in 4 hours)
 - 1 day (deleted on the next day)
 - 1 week (deleted after one week)
- 5 Press **[OK]**. The setting is stored and the Job Box Setting menu reappears.

Storage Media (Selecting the storage media for the jobs)

If the optional SSD and SD card are both installed, it is possible to select which storage media to use.



Note After this setting has been done, turn the machine **OFF** and **ON** again. This is mandatory to make the settings effective.

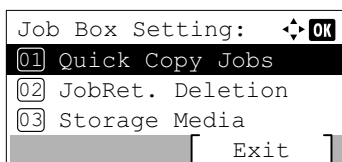

- 1 In the Job Box menu, press Δ or ∇ to select Job Box Setting.
- 2 Press **[OK]**. The Job Box Setting screen appears.

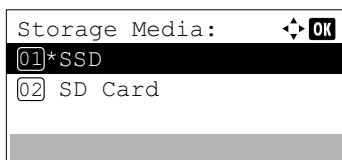

- 3 Press Δ or ∇ to select Storage Media and press **[OK]**. The Storage Media screen appears.
- 4 Press Δ or ∇ to select the desired storage media. The list shows the following media:
 - SSD
 - SD Card
- 5 Press **[OK]**. The setting is stored and the Job Box Setting menu reappears.

Computer Settings (Printer Driver)

Use the procedure below to store data in a Custom Box or a Job Box.

- 1 From the application menu, select **Print**. The Print dialog box displays.
- 2 Click the drop down list of printer names. All the printers installed in Windows are listed. Click the name of the machine.
- 3 Click **Properties**. The Properties dialog box displays.
- 4 Click the **Job** tab and select the **Job storage (e-MPS)** check box to set the function.

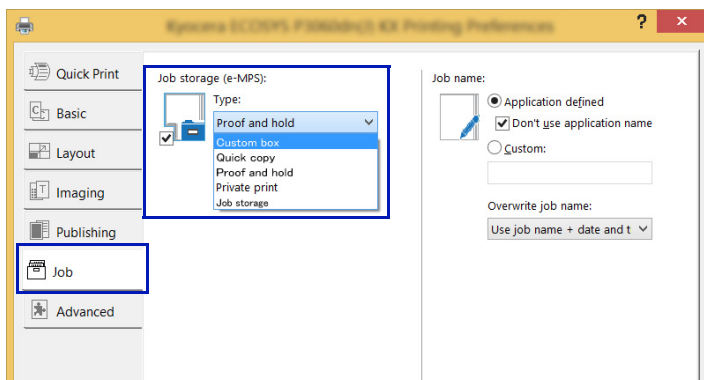

Document Box		Method for setting the printer driver
Custom Box		<ol style="list-style-type: none"> 1 Select Custom box. 2 Click Settings. 3 Select a Custom Box Settings option: <ul style="list-style-type: none"> • Select Use specific box number, and type the box number and password. • Select Prompt for box number, and click OK. When the Custom Box dialog box appears, type a box number from the Defined custom boxes list. If a password was set, type the password. • Select Display box number list, and click OK. When the Custom Box dialog box appears, select a box from the list. If a password was set, type the password. This can be selected if Shared box is selected in the SSD Settings dialog box. • Select Verify box number for each login user, and click OK. When the Custom Box dialog box appears, type a box number. To include a password, select Require password and type the password. This can be selected when Shared box is selected in the SSD Settings dialog box. 4 Click OK to return to the Print dialog box.
Job Box	Quick Copy	Select Quick copy .
	Proof-and-Hold	Select Proof and hold .
	Private Print	Select Private print and set the Access code.
	Stored Job	Select Job storage . Set the Access code if necessary.

 **Note** For information on how to use the printer driver software, refer to the *Printer Driver User Guide*.

6 Status Menu

This chapter contains explanations on the following topics:

Displaying the Status Menu Screen	6-2
Job Status	6-3
Job Log	6-4
USB Keyboard	6-5
Network	6-5
Wi-Fi	6-6
Wi-Fi Direct	6-6
Option Network	6-8

Displaying the Status Menu Screen

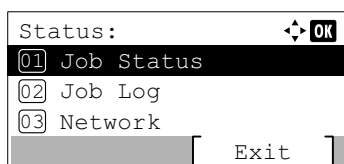
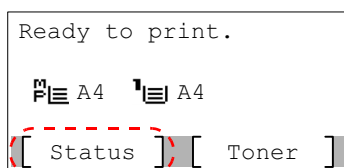

If **Status** is displayed at the left of the bottom row of the message display whilst the machine is printing or awaiting printing, it is possible to display the **Status** menu screen.

Press [Status] (**[Left Select]**). The Status menu screen appears.

The following operations are possible on the Status menu screen:

- Job Status...6-3
- Job Log...6-4
- USB Keyboard...6-5
- Network...6-5
- Wi-Fi...6-6
- Wi-Fi Direct...6-6
- Option Network...6-8



Note USB Keyboard is only displayed when a USB keyboard is connected.

Wi-Fi and Wi-Fi Direct are only displayed when the optional Wireless Network Interface Kit (IB-36) is installed.

Option Network is only displayed when the optional Network Interface Kit (IB-50) or Wireless Network Interface Kit (IB-51) is installed.

Job Status

It is possible to check the status of jobs printing or awaiting printing.

In addition to the jobs printed from computers, it is also possible to check reports such as status pages and jobs printed directly from USB memory.

The information available in the Job Status is listed below.

Item	Content	Results Displayed		
		Display	Icon	Description
Job Name	Job name	Job name		Job name
Status	Job status	Processing	▶	Printing
		Pause		Printing suspended
		Canceling	⊘	Job canceled.
Job Type	Job type	Printer	🖨	Printed from a PC
		Report	📄	Report
		USB	🔌	Printed from USB memory
		Box	📁	Printed from Job Box
Accepted Time	Job reception time	Day/Month/Year Hour:Minute [†] Month/Day/Year Hour:Minute [†] Year/Month/Day Hour:Minute [†]		
User Name	Printed user name	User name		
Printed Pages	Pages printed	***Page(s)		No. of pages
		***/**		Copies completed/Copies specified

[†] The display differs depending on the countries or regions.

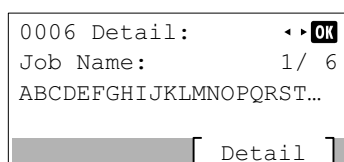
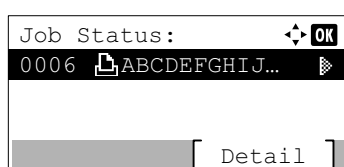

- 1 In the Status menu, press Δ or ∇ to select Job Status.
- 2 Press [OK]. Job Status is displayed and a list is displayed of the job numbers and job names of the jobs currently being printed or awaiting printing. Also, the type of job and results are indicated for each job using icons.
- 3 Press Δ or ∇ to select the name of the job whose details you want to view.
- 4 Press [Detail] ([Right Select]). The Detail screen appears.
The detailed job status covers 6 pages in all. Press \triangleright to view to the next page or \triangleleft to return to the previous page.

Pressing [OK] returns you to the Job Status menu.

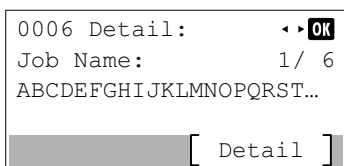

If the entire name shown as the Job Name will not fit on one line, pressing [Detail] (**[Right Select]**) changes to a 3-line name display.

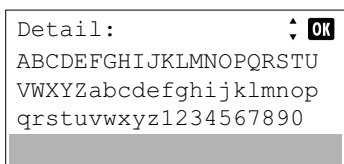

Pressing **[OK]** during 3-line name display returns you to single-line name display.

Job Log

You can use the Job Log to check the history of jobs that have already finished printing.

As well as jobs printed from PCs, this log shows the outcomes for jobs printed directly from USB memory and reports such as status pages.

It is possible to check the log of the 100 most recent jobs.

The information available in the Job Log is listed below.

Item	Content	Results Displayed		
		Display	Icon	Description
Job Name	Job name	Job name		Job name
Result	Job status	OK	OK	Completed normally
		Error	⚠	Error occurred.
		Cancel	⏹	Job canceled.
Job Type	Job type	Printer	🖨	Printed from a PC
		Report	📄	Report
		USB	🔌	Printed from USB memory
		Box	📦	Printed from Job Box
Accepted Time	Job reception time	Day/Month/Year Hour:Minute [†] Month/Day/Year Hour:Minute [†] Year/Month/Day Hour:Minute [†]		
User Name	Printed user name	User name		
Printed Pages	Pages printed	***Page(s)		No. of pages
		***/**		Copies completed/Copies specified

[†] The display differs depending on the countries or regions.

- 1 In the Status menu, press Δ or ∇ to select Job Log.
- 2 Press **[OK]**. Job Log is displayed, along with the job numbers of completed jobs and a list of the job names. The job type and result for each job are also shown as icons.

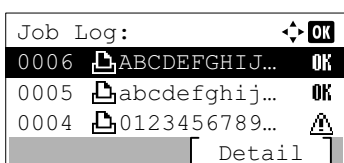

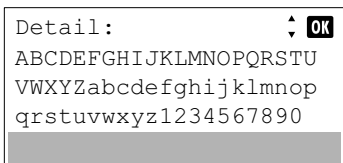
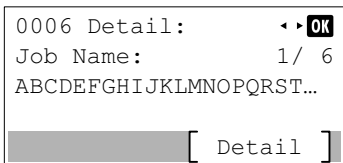

- 3 Press Δ or ∇ to select the name of the job whose details you want to view.
- 4 Press [Detail] ([Right Select]). The Detail screen appears. The detailed job log covers 6 pages in all. Press \triangleright to view to the next page or \triangleleft to return to the previous page. Pressing [OK] returns you to the Job Log menu.

If the entire name shown as the Job Name will not fit on one line, pressing [Detail] ([Right Select]) changes to a 3-line name display.

USB Keyboard

When a USB keyboard is attached, it is possible to check whether the USB keyboard can be used.

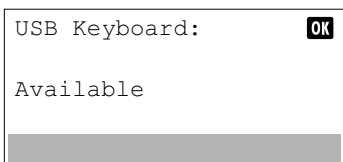

- 1 In the Status menu, press Δ or ∇ to select USB Keyboard.
- 2 Press [OK]. If the USB keyboard is available for use, Available is displayed.

Network

It is possible to check the status of the network for the machine.

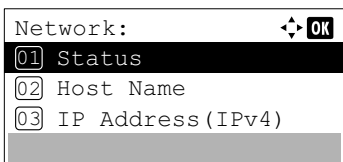

- 1 In the Status menu, press Δ or ∇ to select Network.
- 2 Press [OK]. The Network menu is displayed.
- 3 Press Δ or ∇ to select the item you want to check. The following items can be checked.
 - Status
 - Host Name
 - IP Address(IPv4)
 - IP Address(IPv6)
 - MAC Address
- 4 Press [OK]. The selected details appear.

Wi-Fi

When the optional Wireless Network Interface Kit (IB-36) is installed, it is possible to check the status of the option wireless network.

 **Note** Wi-Fi is only displayed when the optional Wireless Network Interface Kit (IB-36) is installed.

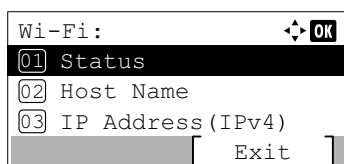

1 In the Status menu, press Δ or ∇ to select Wi-Fi.

2 Press **[OK]**. The Wi-Fi menu is displayed.

3 Press Δ or ∇ to select the item you want to check.

The following items can be checked.

- Status
- Host Name
- IP Address(IPv4)
- IP Address(IPv6)
- NetwkName(SSID)
- MAC Address

4 Press **[OK]**. The selected details appear.

Wi-Fi Direct

You can check the connection status of the optional Wireless Network Interface Kit, and set the network by push-button.

 **Note** Wi-Fi Direct is only displayed when the optional Wireless Network Interface Kit (IB-36) is installed.

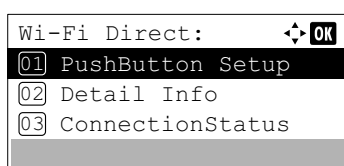

1 In the Status menu, press Δ or ∇ to select Wi-Fi Direct.

2 Press **[OK]**. The Wi-Fi Direct menu is displayed.

The options available in the Wi-Fi Direct settings are as follows:

- PushButton Setup...6-7
- Detail Info...6-7
- ConnectionStatus...6-7

PushButton Setup

If your computer or mobile device does not support Wi-Fi Direct but supports WPS, you can set the network by push-button.

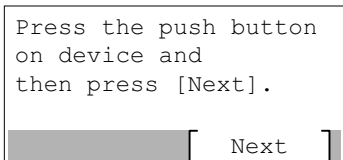

- 1 In the `Wi-Fi Direct` menu, press `△` or `▽` to select `PushButton Setup`.
- 2 Press **[OK]**. A confirmation message is displayed.
- 3 Press `[Next]` (**[Right Select]**).
- 4 When `Device Name` or `NetwkName (SSID)` is displayed and the name is too long to fit on one line, press `[Detail]` (**[Right Select]**) to change the name to 3-line display.

Detail Info

It is possible to check the detail information of the Wi-Fi Direct.

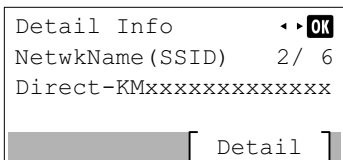
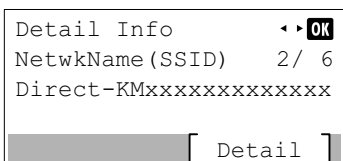

- 1 In the `Wi-Fi Direct` menu, press `△` or `▽` to select `Detail Info`.
- 2 Press **[OK]**. The `Detail Info` screen appears.
The detailed job log covers 6 pages in all. Press `▷` to view to the next page or `◁` to return to the previous page.
Pressing **[OK]** returns you to the `Wi-Fi Direct` menu.
- 3 When `Device Name` or `NetwkName (SSID)` is displayed and the name is too long to fit on one line, press `[Detail]` (**[Right Select]**) to change the name to 3-line display.

ConnectionStatus

It is possible to check the status of the Wi-Fi Direct.

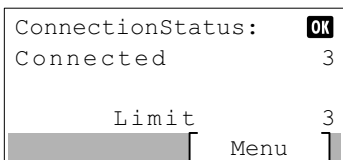

- 1 In the `Wi-Fi Direct` menu, press `△` or `▽` to select `ConnectionStatus`.
- 2 Press **[OK]**. The `ConnectionStatus` screen appears.
Press `[Menu]` (**[Right Select]**) to display the following items.
 - `Disconnect All` (disconnect all Wi-Fi Direct connections)
 - `ConnectedDevices` (display connected devices)"

Option Network

When the optional Network Interface Kit (IB-50) or Wireless Network Interface Kit (IB-51) is installed, it is possible to check the status of the option network.

 **Note** Option Network is only displayed when the Network Interface Kit (IB-50) or Wireless Network Interface Kit (IB-51) is installed.

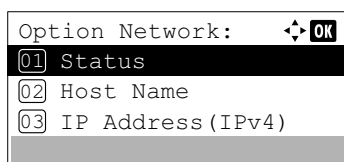

1 In the Status menu, press Δ or ∇ to select Option Network.

2 Press **[OK]**. The Option Network menu is displayed.

3 Press Δ or ∇ to select the item you want to check.

The following items can be checked.

- Status
- Host Name
- IP Address(IPv4)
- IP Address(IPv6)
- NetwkName(SSID) (Only Wireless Network Interface Kit (IB-51))
- MAC Address

Press **[OK]**. The selected details appear.

7 Maintenance

This chapter contains explanations on the following topics:

Toner Container Replacement	7-2
Replacing the Waste Toner Box	7-7
Cleaning the Printer.....	7-9

Toner Container Replacement

The printer displays messages at two stages of toner usage:

- When the printer becomes low on toner, the printer displays the message `Toner is running out.` as the first caution. Note the replacement is not always necessary at this stage. Prepare the new toner kit.
- If you ignore the above message and continue printing, the printer displays the message `Replace toner.` - just before the toner is used up. The printer will stop printing. The toner container must be replaced immediately. Refer to *Replacing the Toner Container on page 7-3.*

Frequency of Toner Container Replacement

The life of the toner containers depends on the amount of toner required to accomplish your printing jobs. According to ISO/IEC 19752 and EcoPrint switched off the toner container can print as follows (A4/Letter paper is assumed): 12,500 images (ECOSYS P3045dn), 15,500 images (ECOSYS P3050dn), 21,000 images (ECOSYS P3055dn for the U.S.A.) or 25,000 images (ECOSYS P3055dn for destination other than the U.S.A. and ECOSYS P3060dn)

Starter Toner Container

The toner container packed with the new printer is a starter toner container. The starter toner container lasts an average of 6,000 images (ECOSYS P3045dn), 8,000 images (ECOSYS P3050dn), or 10,000 images (ECOSYS P3055dn and ECOSYS P3060dn).

Toner Kits

- Toner Container
- Waste Toner Box
- Plastic waste bags for old toner container and old waste toner box
- Installation Guide

IMPORTANT During toner container replacement, temporarily move storage media and computer supplies (such as floppy disks and USB memories) away from the toner container. This is to avoid damaging media by the magnetism of toner.

Always clean the inside of the printer after replacing the toner container. For details, refer to *Cleaning the Printer on page 7-9.*

Kyocera Document Solutions Inc. is not liable against any damages or problems arising from the use of toner containers other than those designated as original Kyocera toner containers. For optimum performance, it is also recommended to use only the Kyocera toner containers which are specifically intended for use in your country or region. If the toner container for another destination is installed, the printer will stop printing.

 **Note** To maintain quality, we recommend using genuine Kyocera toner containers, which must pass numerous quality inspections.

Information Collection on Memory Chips - The memory chip attached to the toner container is designed to improve convenience for the end user; to support the recycling operation of empty toner containers; and to gather information to support new product planning and development. The information gathered is anonymous - it cannot be associated to any specific individual and the data is intended to be used anonymously.

Replacing the Toner Container

This section explains how to replace the toner containers. When replacing the toner container, always replace the waste toner box at the same time. If this box is full, the printer may be damaged or contaminated by the waste toner that may spill over the box.



CAUTION Do not attempt to incinerate the Toner Container. Dangerous sparks may cause burns.

IMPORTANT Before replacing the toner container, remove the paper on the MP tray.



Note You do not have to turn printer power off before starting the replacement. Any data that may be processing in the printer will be deleted if you turn the printer power off.

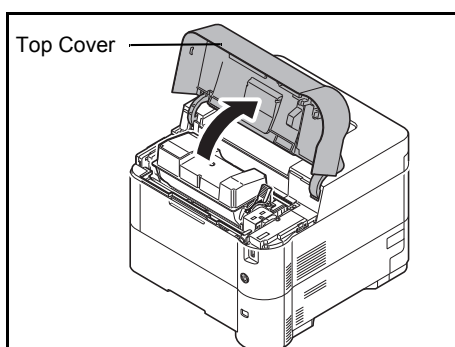

1 Open the top cover.

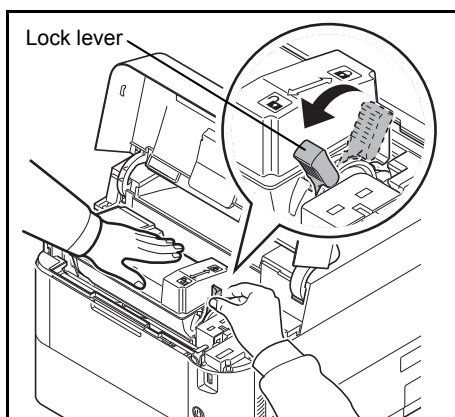

2 Turn the lock lever to the unlock position.

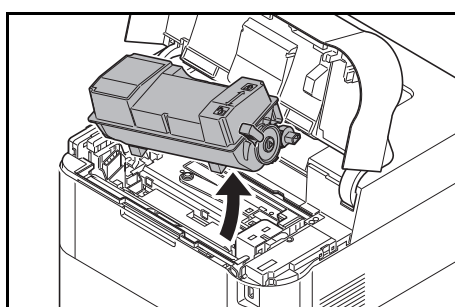

3 Carefully remove the old toner container from the printer.

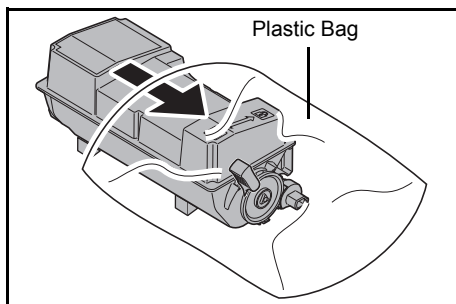

- 4** Put the old toner container in the plastic bag (contained in the toner kit) and discard it later according to the local code or regulations for waste disposal.

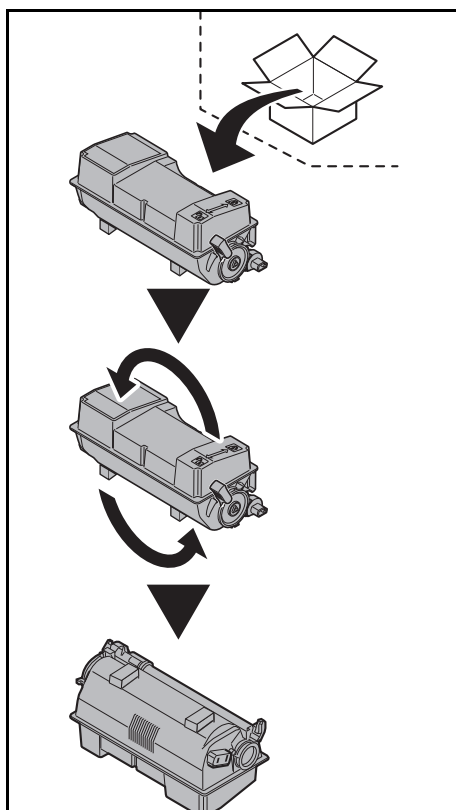

- 5** Take the new toner container out of the toner kit.

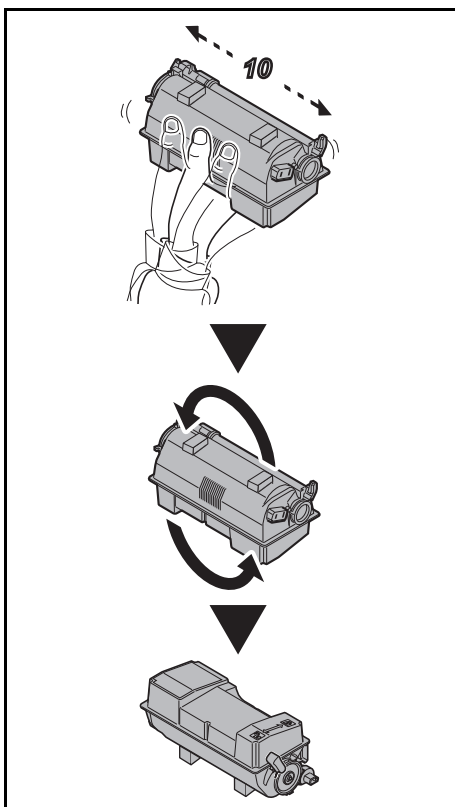

- 6** Shake the new toner container at least 10 times as shown in the figure in order to distribute the toner evenly inside the container. Do not press too firmly on the center of the toner container or touch the toner feed slot.

IMPORTANT Do not touch the part of the toner container indicated on the diagram.

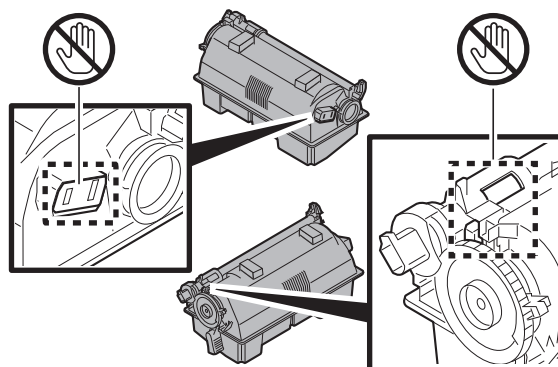

- 7** Set the new toner container in the printer as shown in the figure.

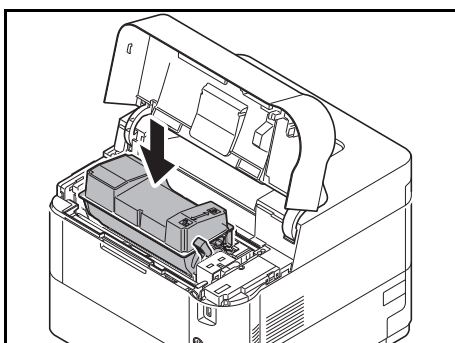

- 8** Push down on the top of the toner container to install it firmly in place.

- 9** Turn the lock lever to the lock position.

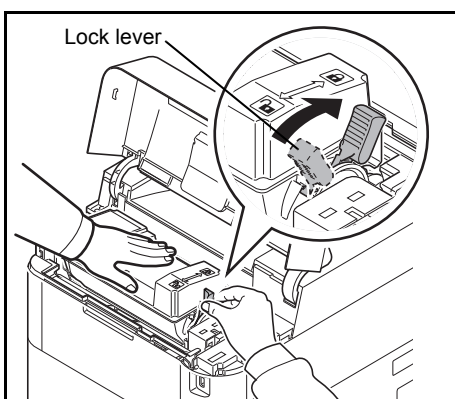

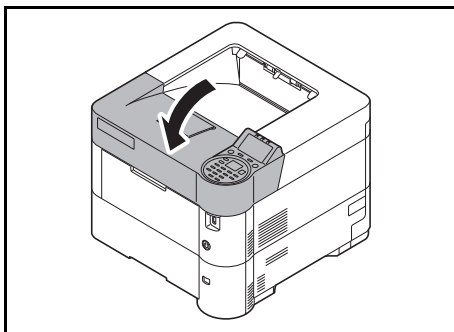

10 Close the top cover.



Note If the top cover (top tray) does not close, check that the new toner container is installed correctly (in step 7). After use, always dispose of the toner container and the waste toner box in accordance with Federal, State and Local rules and regulations.

Proceed to the next section.

Replacing the Waste Toner Box

Replace the waste toner box when the `Waste toner box is full.` message is displayed and when replacing the toner container. A new waste toner box is included with the toner kit. The waste toner box needs to be replaced before the printer will operate.



CAUTION Do not attempt to incinerate the Toner Container. Dangerous sparks may cause burns.

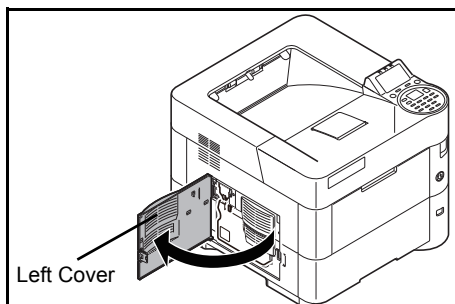

- 1 Open the left cover.

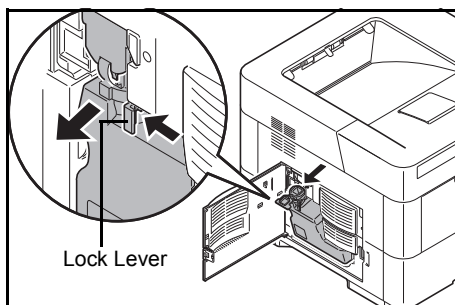

- 2 While holding the waste toner box, press the lock lever and then gently remove the waste toner box.



Note Remove the waste toner box as gently as possible so as not to scatter the toner inside. Do not let the opening of the waste toner box face downward.

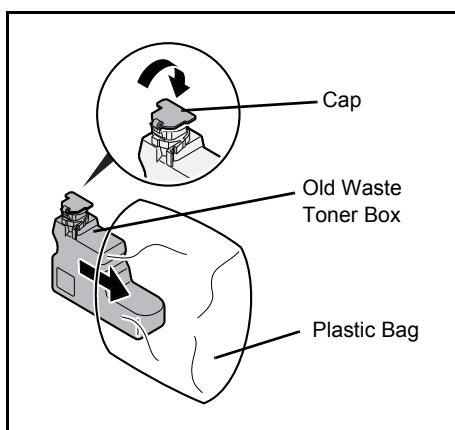

- 3 Close the cap to the old waste toner box after removing the box from the printer.

- 4 To prevent toner from spilling, put the old waste toner box in the plastic bag (contained in the toner kit) and discard it later according to the local code or regulations for waste disposal.

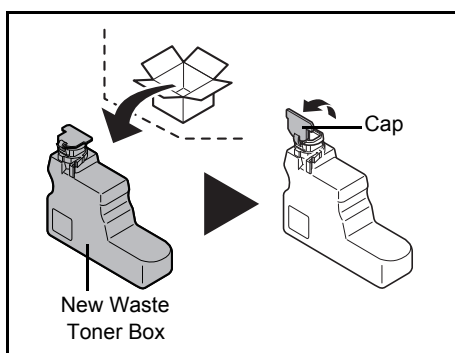

- 5 Open the cap of the new waste toner box.

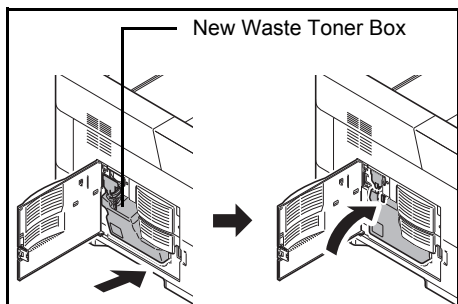

6 Insert the new waste toner box as shown in the figure. When the box is set correctly, it will snap into place.

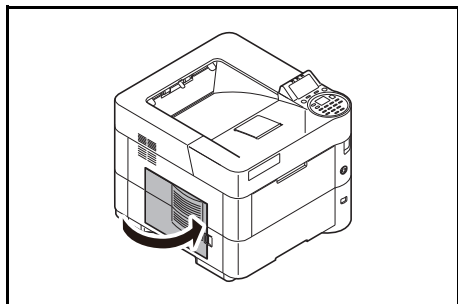

7 Make sure that the waste toner box is correctly inserted and close the left cover.

After replacing the toner containers and the waste toner box, clean the paper transfer unit. For instructions, refer to *Cleaning the Printer* on page 7-9.

Cleaning the Printer

To avoid print quality problems, the interior of the printer must be cleaned with every toner container replacement.

IMPORTANT Before cleaning the printer, remove the paper on the MP tray.

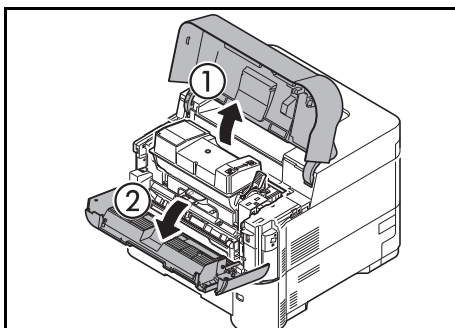

- 1 Open the top cover and front cover.

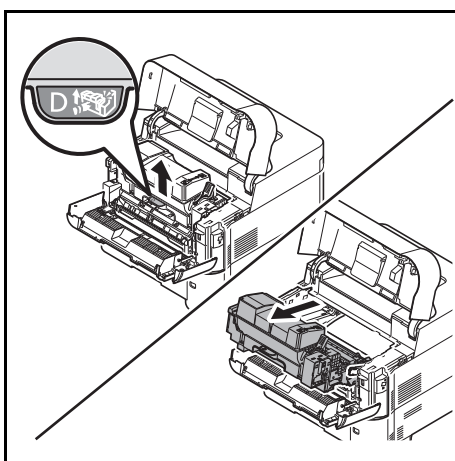

- 2 Pull the developer unit together with the toner container.

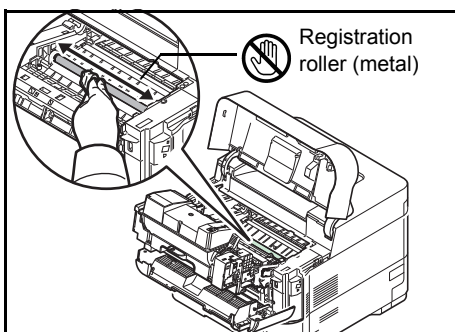

- 3 Use a lint free cloth to clean dust and dirt away from the registration roller (metal).

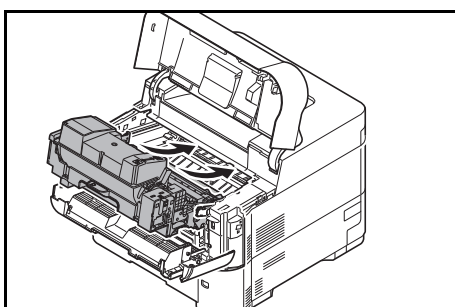

- 4 Insert the developer unit together with the toner container, back into the machine.

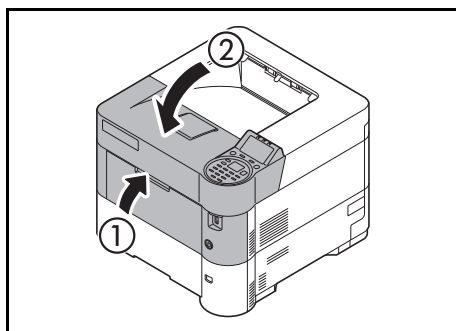

5 Close the front cover and top cover.

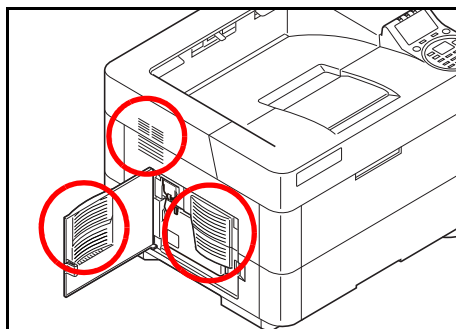

6 Open the left cover. Use a lint free cloth to clean dust and dirt away from the vents.

7 Close the left cover.

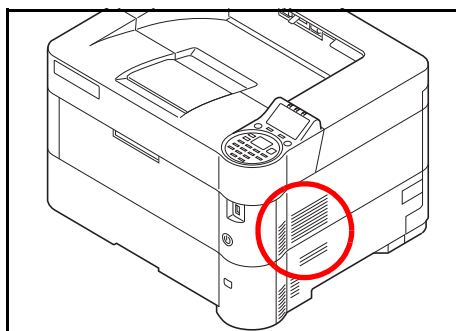

8 Use a lint free cloth to clean dust and dirt away from the vent on the right side of the machine.

Prolonged Non-Use and Moving of the Printer

Prolonged Non-use

If you ever leave the printer unused for a long period of time, remove the power cord from the wall outlet.

We recommend you consult with your dealer about the additional actions you should take to avoid possible damage that may occur when the printer is used next time.

Moving the Printer

When you move the printer:

- Move it gently.
- Keep it as level as possible to avoid spilling toner inside the printer.
- Be sure to consult a service technician before attempting long distance transportation of the printer
- Keep the printer horizontal.



WARNING If you ship the printer, remove and pack the developer unit in a plastic bag and ship them separately from the printer.

8 Troubleshooting

This chapter contains explanations on the following topics:

Troubleshooting	8-2
Error Messages	8-6
Clearing Paper Jams	8-18

If a problem cannot be corrected, contact your service technician.

Troubleshooting

Solving Malfunctions

The table below provides general guidelines for problem solving.

If a problem occurs with your machine, look into the checkpoints and perform procedures indicated on the following pages. If the problem persists, contact your Service Representative.





Note When contacting us, the serial number will be necessary.

To check the serial number, refer to *Checking the Equipment's Serial Number on page i*

Machine Operation Trouble

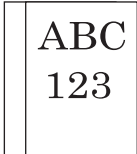

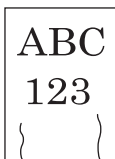
When the following machine operation troubles occur, implement appropriate procedures.



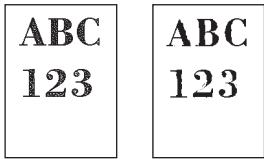
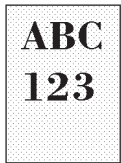
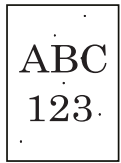

Symptom	Checkpoints	Corrective Actions	Reference Page
An application does not start.	Is the Auto Panel Reset time short?	Set the Auto Panel Reset time to 30 seconds or more.	<i>page 4-107</i>
The screen does not respond when the power switch is turned on.	Check the power cord.	Connect both ends of the power cord securely.	—
Blank sheets are ejected. 	—	Check that the settings of the application software.	—
Paper often jams.	Is the paper loaded correctly?	Load the paper correctly.	<i>page 2-38</i>
	—	Turn the orientation 180 degrees around in which the paper is positioned.	<i>page 2-38</i>
	Is the paper of the supported type? Is it in good condition?	Remove the paper, turn it over, and reload it.	<i>page 2-38</i>
	Is the paper curled, folded or wrinkled?	Replace the paper with new paper.	<i>page 2-38</i>
	Are there any loose scraps or jammed paper in the machine?	Remove any jammed paper.	<i>page 8-18</i>
2 or more sheets are overlaps when ejected. (multi feed) 	—	Load the paper correctly.	<i>page 2-38</i>

Symptom	Checkpoints	Corrective Actions	Reference Page
Printouts are wrinkled. 	Is the paper loaded correctly?	Load the paper correctly.	<i>page 2-38</i>
	—	Turn the orientation 180 degrees around in which the paper is positioned.	<i>page 2-38</i>
	Is the paper damp?	Replace the paper with new paper.	<i>page 2-38</i>
Printouts are curled. 	—	Turn the paper over in the cassette, or turn the orientation 180 degrees around in which the paper is positioned.	<i>page 2-38</i>
	Is the paper damp?	Replace the paper with new paper.	<i>page 2-38</i>
Printer driver cannot be installed.	Is the driver installed with the host name while Wi-Fi or Wi-Fi Direct function is available?	Specify the IP address instead of the host name.	—
Cannot print.	Is the machine plugged in?	Plug the power cord into an AC outlet.	—
	Is the machine powered on?	Turn on the power switch.	<i>page 2-35</i>
	Are the USB cable and network cable connected?	Connect the correct USB cable and network cable securely.	—
Cannot print with USB memory. USB memory not recognized.	Is the USB host blocked?	Select Unblock in the USB host settings.	<i>page 4-124</i>
	—	Check that the USB memory is securely plugged into the machine.	—
While Auto-IP is already set to On, the IP address is not assigned automatically.	Is a value other than "0.0.0.0" entered for the link local address of TCP/IP(v4)?	Enter "0.0.0.0" for the IP address of TCP/IP(v4).	<i>page 2-5</i>
The machine is emitting steam in the area around the paper ejection slot.	Check the room temperature to see if it is low, or if damp paper was used.	Depending on the printing environment and the paper's condition, the heat generated during printing will cause the moisture in the paper to evaporate, and the steam emitted may look like smoke. This is not a problem, and you can continue printing. If the steam concerns you, raise the room temperature, or replace the paper with a newer, dryer paper.	—

Printed Image Trouble

When the following printed image trouble occurs, implement appropriate procedures.

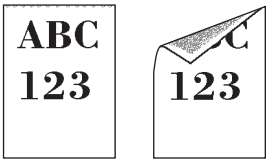
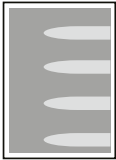
Symptom	Checkpoints	Corrective Actions	Reference Page
<p>Printed images are totally too light.</p> 	Is the paper damp?	Replace the paper with new paper.	page 2-38
	Have you changed the density?	Select appropriate density level.	page 4-54
	Is the toner distributed evenly within the toner container?	Shake the toner container from side to side several times.	page 7-3
	Is EcoPrint mode enabled?	Disable EcoPrint mode.	page 4-53
	—	Make sure the paper type setting is correct for the paper being used.	page 4-39
	—	Select the [Menu] > Adjust/Maint. > Service Setting > Drum > [OK] > [OK] .	—
<p>Printed images are too dark even though the background of the scanned original is white.</p> 	Have you changed the density?	Select appropriate density level.	page 4-54
	—	Select the [Menu] > Adjust/Maint. > Service Setting > Drum > [OK] > [OK] .	—
<p>Black dots appear on the white background when white original is scanned.</p> 	—	Select the [Menu] > Adjust/Maint. > Service Setting > Drum2, load A4 paper in the multi purpose tray, and select [OK] > [OK] . (Except ECOSYS P3045dn)	—
	—	Select the [Menu] > Adjust/Maint. > Service Setting > Drum > [OK] > [OK] .	—
<p>Printed images are fuzzy.</p> 	Is the device used in an environment with high humidity or where the temperature or humidity changes suddenly?	Use in an environment that has suitable humidity.	—
	—	Select the [Menu] > Adjust/Maint. > Service Setting > Drum > [OK] > [OK] .	—

Symptom	Checkpoints	Corrective Actions	Reference Page
<p>Printed images are skewed.</p> 	Is the paper loaded correctly?	Check the position of the paper width guides.	page 2-38
<p>The altitude is 1000 m or higher and irregular horizontal white lines appear in the image.</p> 	—	Select [Menu] > Adjust/Maint. > Service Setting > Altitude Adj. > 2001 - 3000m or 3001 - 3500m, and select [OK] > [OK] .	—
<p>The altitude is 1000 m or higher and dots appear in the image.</p> 	—	Select [Menu] > Adjust/Maint. > Service Setting > Altitude Adj. > 2001 - 3000m or 3001 - 3500m, and select [OK] > [OK] .	—
<p>Dirt on the top edge or back of the paper.</p> 	Is the interior of the machine dirty?	Clean the interior of the machine.	page 7-9
<p>Part of the image is periodically faint or shows white lines.</p> 	—	Select the [Menu] > Adjust/Maint. > Service Setting > Drum > [OK] > [OK] .	—
<p>The previous image remains and lightly printed.</p> 	—	Make sure the paper type setting is correct for the paper being used.	page 4-39

Error Messages

The following table lists errors and maintenance messages that you can be dealt with by yourself. If `Machine failure. Call service.` appears, turn off the printer, disconnect the power cord, and contact your service technician.

If `Machine failure. Call service. OR Error occurred. Turn the power switch off and on. is displayed`, turn off the printer then turn it back on to see if the printer has recovered. If the printer has not recovered, turn off the printer, disconnect the power cord, and contact your service representative or authorized service center.

Some errors cause the alarm to sound. To stop the alarm, press **[Cancel]**.

Message	Corrective Action
<p>A machine administrator right is required.</p>	<p>You can only change the settings selected when logged in as a user with machine administrator privileges.</p>
<p>Access denied. You cannot login.</p>	<p>The Log in operation failed for the specified number of times so it is no longer possible to attempt to log in. Contact a system administrator.</p>
<p>Access point was not detected.</p>	<p>It was not possible to connect to the network with the optional wireless network interface kit. Check if the access point has been set correctly. For details, refer to <i>Wireless Network (Wireless network settings)</i> on page 4-83.</p>
<p>Account error. Press [OK].</p>	<p>This message is displayed when the Job Accounting function is enabled and an attempt to specify job accounting settings or to register or delete an account fails. To return the printer to the print-ready status, press [OK].</p>

Message	Corrective Action
<p>Add paper in casset.#</p>	<p>The paper has run out in the paper source displayed. Supply paper according to the paper source displayed (paper cassettes, MP tray, optional paper feeders, or Bulk Paper Feeder).</p>
<p>Add paper in MP tray.</p>	
<p>Add paper in BulkFee.</p>	
<p>Administrator only.</p>	<p>You can only change the settings selected when logged in as a user with administrator privileges.</p>
<p>Box limit exceeded.</p>	<p>The box capacity is full. Either delete files or change the capacity of the box. For details, refer to <i>Custom Box operation (Box creation, editing and deletion)</i> on page 5-4.</p>
<p>Canceling...</p>	<p>Displayed when data is being canceled.</p>
<p>Cannot connect.</p>	<p>This appears when the Wi-Fi or Wi-Fi Direct connection did not complete. Check the settings, and check the signal conditions. For details, refer to <i>Network (Network settings)</i> on page 4-60.</p>

Message	Corrective Action
<p>Cannot connect to Authentication Server.</p>	<p>Press [OK] and check the following items:</p> <ul style="list-style-type: none"> • Registration to Authentication Server • Password and computer address for Authentication Server • Connection of Network <p>For details, refer to <i>Netwk Auth. Set (Netwk authentication setting)</i> on page 4-131.</p>
<p>Cannot connect to the network. Check the network.</p>	<p>Unable to connect to the optional network. Check the optional network settings. For details, refer to <i>Optional Network (Optional Network settings)</i> on page 4-82.</p>
<p>Cannot connect. Multiple access points are enabled.</p>	<p>Is the push button on the multiple access points pressed simultaneously? Specify an access point which you want to use. and press the push button again. Retry the connection by specifying an access point after waiting for a while.</p>
<p>Cannot duplex print on this paper.</p>	<p>You attempted to print with a paper size and paper type that cannot be used for duplex printing. Press [Continue] ([Right Select]) to print onto one-side of the paper only.</p>
<p>Cannot execute this job. Restricted by Authorization settings.</p>	<p>This message is shown when operations are restricted in the account when job accounting is effective. To change the account settings, refer to <i>Detail/Edit (Checking/editing registered account ID settings)</i> on page 4-145.</p>
<p>Cannot perform.</p>	<p>It is not possible to perform sanitization because a job is being processed, etc.</p>
<p>Cannot recognize.</p>	<p>Make sure your ID card has been registered.</p>

Message	Corrective Action
<p>Cannot recognize ID card.</p>	<p>Make sure the USB connector of the ID card reader is correctly connected to the machine. If USB Host is set to <code>Block</code>, change the setting to <code>Unblock</code>.</p>
<p>Cannot remove the memory while in use.</p>	<p>This message is displayed when <code>Remove Memory</code> was selected while a USB memory was being used. The previous screen is displayed again 1 or 2 seconds.</p>
<p>Cassette# not loaded.</p>	<p>The corresponding paper cassette is not installed. Install the cassette.</p>
<p>Check cassette #.</p>	<p>This message is displayed when a paper lift error has occurred in the paper source's cassette. Pull out the cassette for the paper source displayed (either the paper cassettes or optional paper feeders) and check if the paper is loaded correctly. The message <code>Call service.</code> is displayed when this error occurs repeatedly.</p>
<p>Close left cover.</p>	<p>The left cover of the printer is open. Close the left cover.</p>
<p>Close rear cover.</p>	<p>The rear cover of the printer is open. Close the rear cover.</p>
<p>Close top cover.</p>	<p>The top cover of the printer is open. Close the printer top cover.</p>

Message	Corrective Action
<p>Enclose the IPv6 address in brackets [].</p>	<p>The IPv6 address entered in the host name is not enclosed in brackets []. To enter the IPv6 address, enclose the address in brackets []. (e.g., [3ae3:9a0:cd05:b1d2:28a:1fc0:a1:10ae]:140)</p>
<p>Error occurred. Turn the power switch off and on. #####</p>	<p>Press the power switch to turn off, and then press it again to turn on. If this message still remains, press the power switch to turn off, and contact your service representative.</p>
<p>Failed to get the network user information.</p>	<p>An error occurred when obtaining user information after the authentication. Log in again.</p>
<p>File was deleted. Check the document box.</p>	<p>The file or box selected does not exist. Check that the box has not been deleted, or that the file has not been deleted or moved.</p>
<p>Format SD card.</p>	<p>The SD card inserted in the printer is not formatted, and therefore cannot be read or written. To format an SD card, follow the procedure in <i>Format SD Card (Formatting the SD card)</i> on page 4-102.</p>
<p>Format SSD.</p>	<p>The SSD inserted in the printer is not formatted, and therefore cannot be read or written. To format an SSD, follow the procedure in <i>Format SSD (Formatting the SSD)</i> on page 4-101.</p>

Message	Corrective Action
<p>Incorrect account ID.</p>	<p>The Account ID does not match. Check the registered Account ID. For more information, refer to <i>Job Account.Set. (Job Account setting) on page 4-140.</i></p>
<p>Incorrect account ID. Press [OK].</p>	<p>This message is displayed when the Job Accounting function is enabled and no account is set for a transmitted print job or the specified account is not registered (the incorrect account is set). To return the printer to the print-ready status, press [OK]. For more information, refer to <i>Job Account.Set. (Job Account setting) on page 4-140.</i></p>
<p>Incorrect ID.</p>	<p>The user ID entered for a private job is not correct. Check the user ID that you specified on the printer driver.</p>
<p>Incorrect login user name or password.</p>	<p>The NTLM server rejected the authentication. Enter the correct Login User Name or Password.</p>
<p>Incorrect login user name or password. Job is canceled.</p>	<p>Enter the correct Login User Name or Login Password.</p>
<p>Incorrect password.</p>	<p>Enter the correct password.</p>
<p>Job Accounting restriction exceeded. Press [OK].</p>	<p>This message is displayed when the Job Accounting function is enabled and an attempt has been made to exceed the print limit set for each account. To return the printer to the print-ready status, press [OK]. For more information, refer to <i>Job Account.Set. (Job Account setting) on page 4-140.</i></p>

Message	Corrective Action
<p>Job not stored. Press [OK].</p>	<p>The job is canceled. Press [OK].</p>
<p>KPDL error. Press [OK].</p>	<p>Current print processing cannot continue because of occurrence of KPDL error. To print out an error report, display <code>KPDL Error Rpt.</code> from the menu system, and select <code>On</code>. Press [OK] to resume printing. You can abandon printing by pressing [Cancel]. If Auto Error Clear is set to <code>On</code>, printing will be automatically resumed after a preset period of time.</p>
<p>Limit exceeded. You cannot add any more.</p>	<p>The added box exceeded the maximum number of box. Delete it if there is a unnecessary box. For details, refer to <i>Custom Box operation (Box creation, editing and deletion)</i> on page 5-4.</p>
<p>Load paper in cassette #. A4</p> <p style="text-align: center;">↓ ↑</p> <p>Different paper size is set. Check paper size.</p>	<p>The size of the paper in the cassette and the paper size on the paper size dial are not the same. Check the paper size.</p>
<p>Load paper in Bulk Feeder. A4 Plain</p>	<p>No paper in the Bulk Feeder matches the print data. Set paper in the MP tray. Press <code>[Continue]</code> ([Right Select]) to resume printing. If you want to print from a different paper source, press <code>[Alt]</code> ([Left Select]) to display <code>Alternative:</code> and you can change the source for paper feeding. You can abandon printing by pressing [Cancel].</p>

Message	Corrective Action
<p>Load paper in cassette #.</p> <p>A4</p> <p>Plain</p>	<p>The paper cassette matching the paper size and paper type of the print job is empty. Load paper into the paper cassette as displayed in place of #. Press [Continue] ([Right Select]) to resume printing.</p> <p>If you want to print from a different paper source, press [Alt] ([Left Select]) to display <i>Alternative:</i> and you can change the source for paper feeding. You can abandon printing by pressing [Cancel].</p>
<p>Load paper in MP tray.</p> <p>A4</p> <p>Plain</p>	<p>There is no paper cassette installed in the printer that matches the paper size and paper type of the print job. Set paper in the MP tray. Press [Continue] ([Right Select]) to resume printing. (Note that feeding the paper having a paper size which does not match the current paper size from the MP tray can cause paper jam.)</p> <p>If you want to print from a different paper source, press [Alt] ([Left Select]) to display <i>Alternative:</i> and you can change the source for paper feeding. You can abandon printing by pressing [Cancel].</p>
<p>Low security</p>	<p>This message is displayed when <code>Low</code> was selected in Security Level.</p>
<p>Machine failure.</p> <p>Call service.</p> <p>#####:0123456</p>	<p>#### represents a mechanical error (#=0, 1, 2, ...). Call for service. The printer does not operate when this message is displayed. The total number of pages printed is also indicated, e.g. 0123456.</p> <p>Make a note of the error code displayed on the message display, and contact your service representative.</p>
<p>Memory is full.</p> <p>Print job cannot be processed completely.</p>	<p>The total amount of data received by the printer exceeds the printer's internal memory.</p> <p>Press [OK] to resume printing. You can abandon printing by pressing [Cancel]. If Auto Error Clear is set to <code>On</code>, printing will be automatically resumed after a preset period of time.</p>
<p>No multi copies.</p> <p>Press [OK].</p>	<p>Multi copies cannot be printed because RAM disk is disabled or the SSD is not installed. Try adding more memory or installing SSD, and configuring the RAM disk settings.</p> <p>Press [OK] to print only one copy.</p>
<p>Non-genuine Toner.</p> <p>Press [Help].</p>	<p>This message is displayed if the installed toner container is non-genuine. The manufacturer assumes no responsibility for damage caused by a non-genuine toner.</p> <p>When you want to use the toner container currently installed, press [OK] and [Cancel] simultaneously for 3 seconds or more.</p>

Message	Corrective Action
 <p>Paper jammed ##### [Help]</p>	<p>A paper jam has occurred. The location of the paper jam is indicated in place of the #'s. For details, refer to <i>Clearing Paper Jams on page 8-18</i></p>
<p>Paper path error. Set Cassette #.</p>	<p>There is no paper cassette in the feeder, or the cassette is not inserted properly. After reinserting the corresponding paper cassette, you should be able to print. When two or more optional feeders are installed and the lowest one is selected, the same message will appear if any of the upper paper feeder and the printer cassette is improperly installed.</p>
<p>RAM disk error. Press [OK].</p> <p style="text-align: right;">##</p>	<p>A RAM disk error has occurred. Look at the error code given in place of ##. The possible error codes and their descriptions are as follows.</p> <p>02: RAM Disk Mode is set to Off. Set the setting to On. Refer to <i>RAM Disk Mode (Setting the RAM disk) on page 4-100</i>.</p> <p>03: The RAM disk is write protected using command operation. Remove the write protection using the command.</p> <p>04: No disk space. Purge unnecessary files or increase the RAM disk size. For more information, refer to <i>RAM Disk Size (RAM disk size setting) on page 4-101</i>.</p> <p>05: The desired file does not exist in the RAM disk. Stored the file in the RAM disk.</p> <p>10: The file stored in the RAM disk is write protected using command operation. Remove the write protection using the command.</p>
<p>Refreshing drum... Please wait.</p>	<p>The machine is under the adjustment to maintain its quality. Please wait.</p>
<p>Registered numbers exceeded. Cannot add.</p>	<p>There are already 100 accounts registered so it is not possible to register any new accounts.</p>
<p>Replace MK.</p>	<p>Replace Maintenance Kit which is displayed on the message display. Contact your Service Representative.</p>

Message	Corrective Action
<p>Replace the toner.</p>	<p>Toner has run out in the toner container. Replace the toner container using a new toner kit. The printer does not operate when this message is displayed.</p>
<p>Restricted by Job Accounting. Press [OK].</p>	<p>This message is displayed when printing was attempted, despite the Job Account function being on with Restriction applied as the job limit for each job account. To return the printer to the print-ready status, press [OK]. For more information, refer to <i>Job Account.Set. (Job Account setting)</i> on page 4-140.</p>
<p>SD card error. Press [OK]. ##</p>	<p>An SD card error has occurred. Look at the error code given in place of ##. The possible error codes and their descriptions are as follows. 02: The printer does not support the SD card inserted, or the SD card is broken. Install the correct SD card. For details, refer to <i>SD/SDHC Memory Card</i> on page A-7. 03: The SD card is write protected using command operation. Remove the write protection using the command. 04: There is not enough space in the SD card. Delete unnecessary files or use a new SD card. 05: The desired file does not exist in the SD card. Stored the file in the SD card. 10: The file stored in the SD card is write protected using command operation. Remove the write protection using the command.</p>
<p>SSD error. Press [OK]. ##</p>	<p>An SSD error has occurred. Look at the error code given in place of ##. The possible error codes and their descriptions are as follows. 03: The SSD is write protected using command operation. Remove the write protection using the command. 04: There is no available SSD space. Delete unnecessary files, etc., in order to free up space. 05: The desired file does not exist in the SSD. Stored the file in the SSD. 10: The file stored in the SSD is write protected using command operation. Remove the write protection using the command.</p>
<p>The device cannot be connected because allowed connections would be exceeded.</p>	<p>Are three handheld devices connected simultaneously? Cancel a connection to a portable device that is not being used, or set the machine's auto disconnect time to break portable device connections.</p>
<p>The file name already exists. You cannot copy.</p>	<p>Copying is not possible because data with the same file name exists at the destination. Delete the data with the same file name at the destination before copying.</p>

Message	Corrective Action
<p>The user name is not registered.</p>	<p>The login user name entered is not registered. Check the login user name.</p>
<p>The waste toner box is full.</p>	<p>Replace the waste toner box. For details, refer to <i>Replacing the Waste Toner Box on page 7-7</i>.</p>
<p>The waste toner box is improperly installed.</p>	<p>The waste toner box is not installed correctly. Set it correctly. For details, refer to <i>Replacing the Waste Toner Box on page 7-7</i>.</p>
<p>This account ID is already registered.</p>	<p>The account ID set has already been registered. Register a different account ID.</p>
<p>This login user name already registered.</p>	<p>The changed login user name has already been registered. Set a different login user name.</p>
<p>Toner is low.</p>	<p>The toner has run low. Ensure that a new toner container is available without delay. For details, refer to <i>Toner Container Replacement on page 7-2</i>.</p>
<p>Top tray is full of paper. Remove the paper.</p>	<p>Remove paper from the top tray. Printing then resumes.</p>

Message	Corrective Action
<div style="border: 1px solid black; padding: 5px;"> <p>Unknown toner installed. PC</p> </div>	<p>This message is displayed if the installed toner container's regional specification does not match the machine's. Install the specified toner container.</p>
<div style="border: 1px solid black; padding: 5px;"> <p>USB memory error. Press [OK].</p> <p style="text-align: right;">##</p> </div>	<p>An error has occurred in the USB memory device. Look at the error code given in place of ##. The possible error codes and their descriptions are as follows. 01: The amount of data that can be saved at once has been exceeded. Split the large file into multiple smaller files. The USB memory is write protected. Remove the write protection. The USB memory is broken. Even if the problem is not solved, format the USB memory with the device or use the new USB memory compatible with the printer. 04: There is no available space. Delete unnecessary files, etc., in order to free up space.</p>

Clearing Paper Jams

If paper jams in the paper transport system, or no paper sheets are fed at all, the Paper jam message appears and the location of the paper jam (the component where the paper jam has occurred) is also indicated. Status Monitor or Command Center RX can indicate the location of the paper jam (the component where the paper jam has occurred). Remove the paper jam. After removing the paper jam, the printer will resume printing.

IMPORTANT The printer may not feed the paper correctly depending on the paper type. Print several pages to confirm whether the printer can feed the paper. To feed thick paper smoothly, you can select the half speed mode from the printer driver. For more information, refer to *Half Speed Mode (Printer Driver Settings)* on page 3-8.

Possible Paper Jam Locations

The figure below shows the printer's paper paths including the optional paper feeder. The locations where paper jams might occur are also shown here, with each location explained in the table below. Paper jams can occur in more than one component on the paper paths.

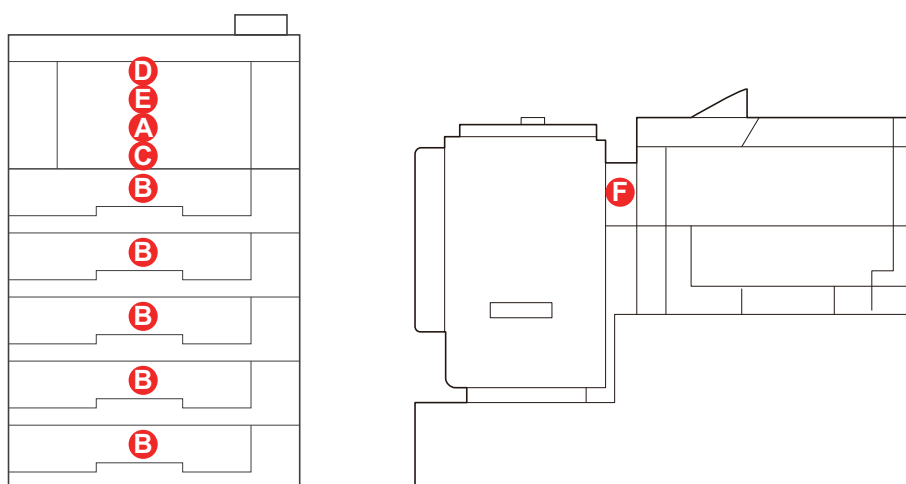

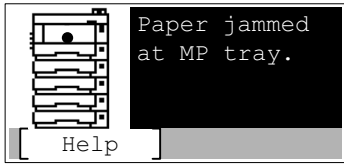
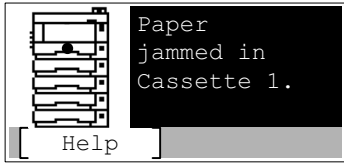
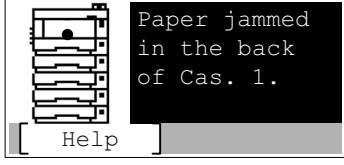
Paper Jam Message	Paper jam location	Description	Reference Page
	A	Paper is jammed at the MP tray.	page 8-20
	B	Paper is jammed at the paper cassette. The cassette number can be 1 (topmost) to 5 (bottom).	page 8-20
	C	Paper is jammed inside the duplex section.	page 8-21

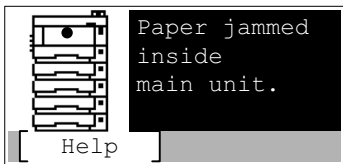
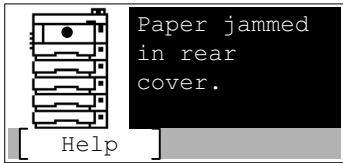
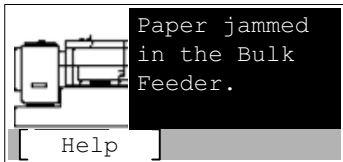
Paper Jam Message	Paper jam location	Description	Reference Page
	D	Paper is jammed inside the printer.	<i>page 8-22</i>
	E	Paper is jammed inside the rear unit.	<i>page 8-24</i>
	F	Paper is jammed at the optional bulk paper feeder.	<i>page 8-25</i>

General Considerations for Clearing Jams

Bear in mind the following considerations when attempting paper jam removal:

- If paper jams occur frequently, try using a different type of paper, replace the paper with paper from another ream, or flip the paper stack over. The printer may have problems if paper jams recur after the paper is replaced.
- Whether or not the jammed pages are reproduced normally after printing is resumed, depends on the location of the paper jam.

Precautions with Paper Jams

- Do not reuse jammed papers.
- If the paper tears during removal, be sure to remove any loose scraps of paper from inside the machine. Scraps of paper left in the machine could cause subsequent jamming.

Utilizing Help Messages

When Paper Jam is displayed, press [Help] (**[Left Select]**) to display the procedure to clear the jam.

Press ▽ to display the next step or press △ to display the previous step.

Press **[OK]** to exit the online help message display.

MP Tray

Paper is jammed at the MP tray. Remove the jammed paper using the procedure given below.

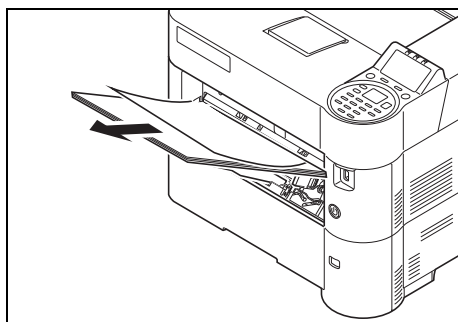

- 1 Remove the paper jammed at the MP tray.

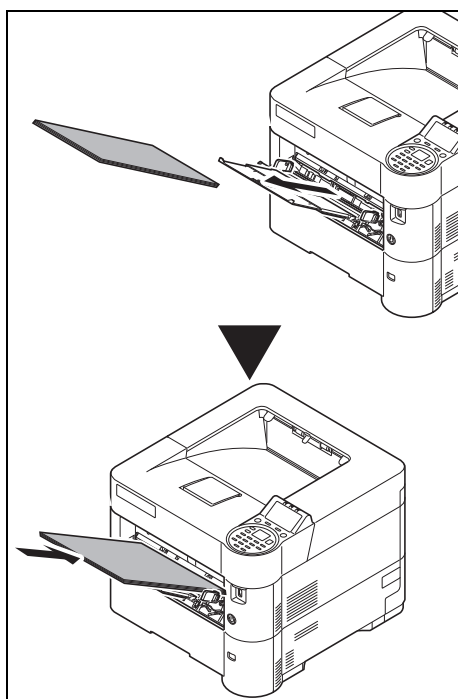

- 2 Temporarily take the paper remaining in the MP tray out and then put it back in again.

Paper Cassette/Paper Feeder

Paper is jammed at the cassette. Remove the jammed paper using the procedure given below. Paper jams in the cassette of the optional paper feeder are removed in the same way.

This section explains procedures using Cassette 1 as an example.

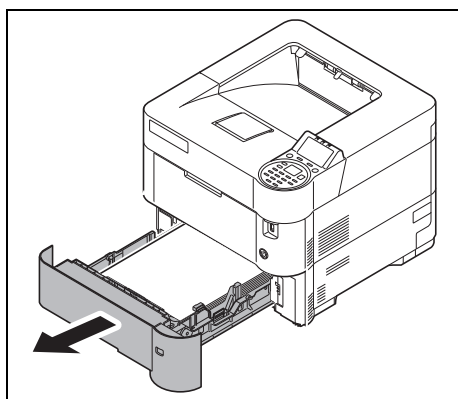

- 1 Pull out the cassette or optional paper feeder.

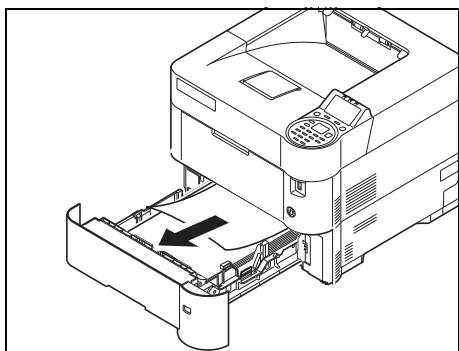

2 Remove any partially fed paper.



Note Check to see if paper is loaded correctly. If not, reload the paper.

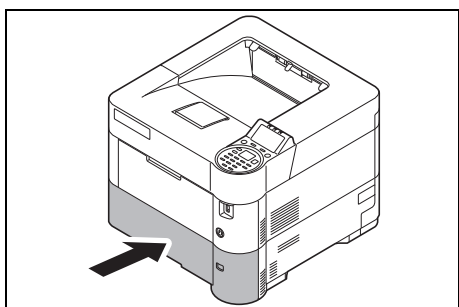

3 Push the cassette back in securely. The printer warms up and resumes printing.

Duplex Unit

Paper is jammed in the duplex section. Remove the jammed paper using the procedure given below.

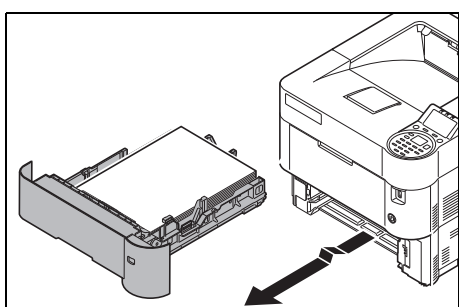

1 Pull out the cassette from the machine.

IMPORTANT When pulling out the cassette from the machine, ensure that it is supported and does not fall out.

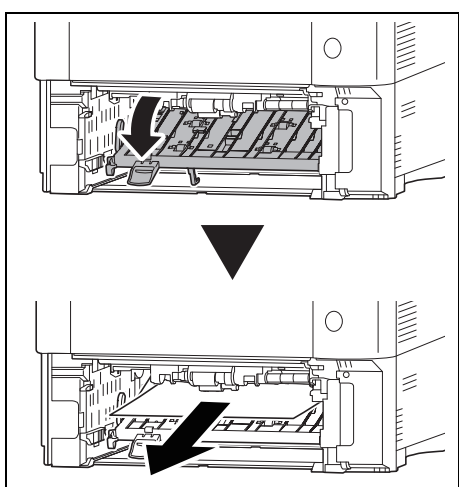

2 Open the duplex front cover and remove any jammed paper.

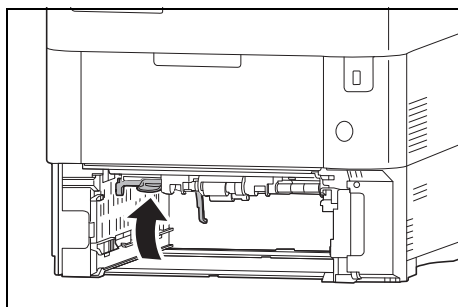

3 Close the duplex front cover.

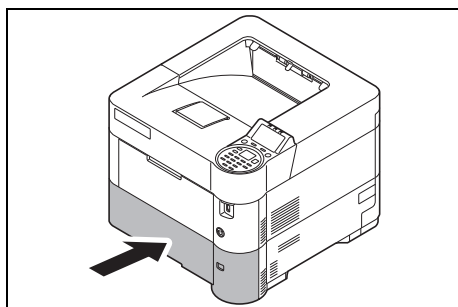

4 Insert the cassette into the slot in the printer. The printer warms up and resumes printing.

Inside the Printer

Paper is jammed inside the printer . Remove the jammed paper using the procedure given below.

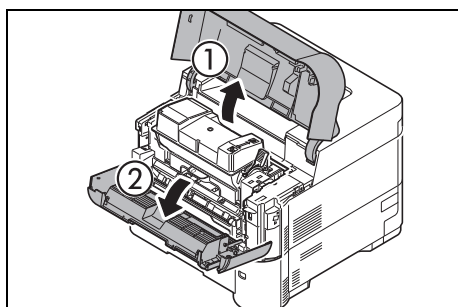

1 Open the top cover and front cover.

IMPORTANT Before clearing the jammed paper, remove the paper on the MP tray.

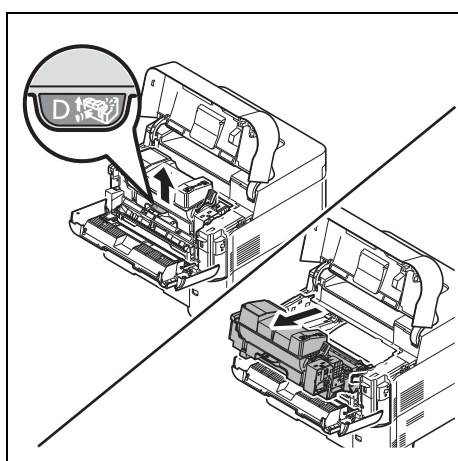

2 Pull the developer unit together with the toner container.

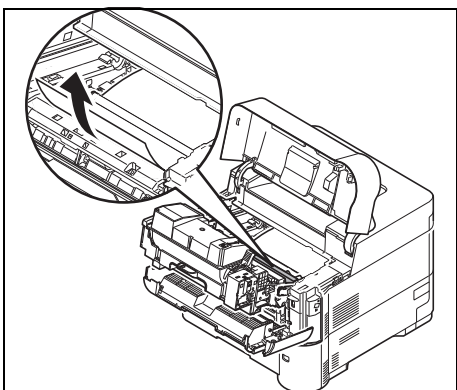

3 Remove the paper from the printer

If the jammed paper appears to be pinched by rollers, pull it shown in the figure.



Note If you cannot find a paper jam, try checking inside the rear of the printer. Refer to *Rear Unit on page 8-24*.

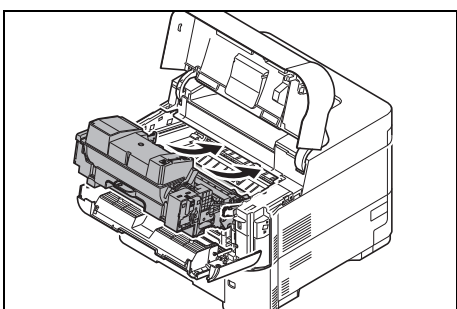

4 Insert the developer unit together with the toner container, back into the machine.

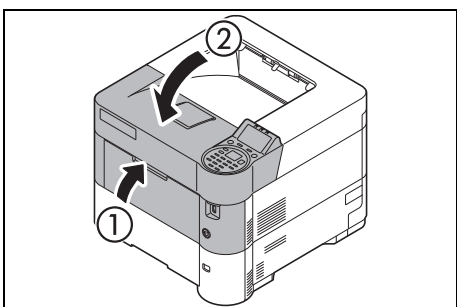

5 Close the front cover and top cover. The printer warms up and resumes printing.

Rear Unit

Paper is jammed in the rear cover . Remove the jammed paper using the procedure given below.

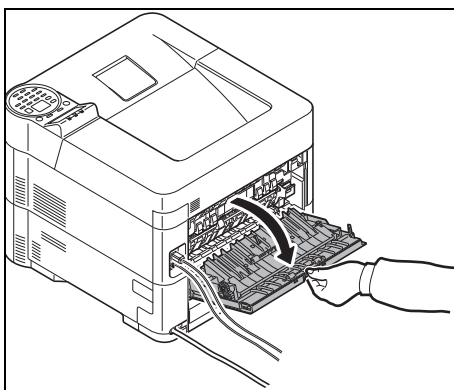

- 1 If paper is not completely ejected into the top tray, open the rear cover.

IMPORTANT If the optional Faceup Output Tray is installed, remove it before opening the rear cover.

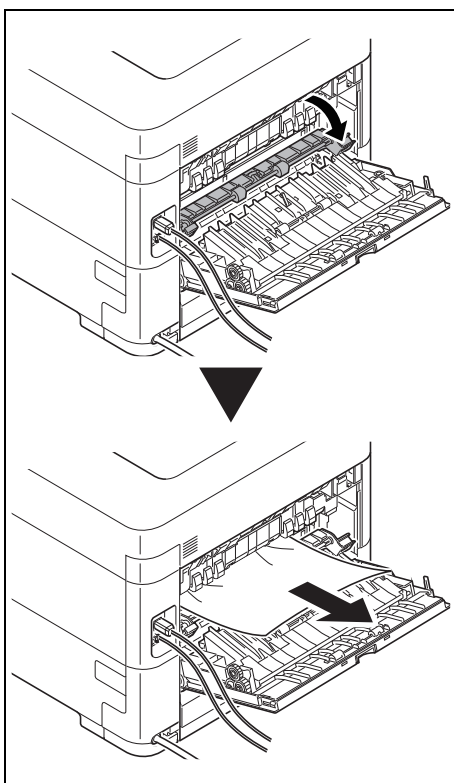

- 2 Open the fuser cover and remove the jammed paper by pulling it out.



Note If you cannot find a paper jam, try checking inside the rear of the printer.



CAUTION The fuser unit inside the printer is hot. Do not touch it with your hands as it may result in burn injury. Remove jammed paper carefully.

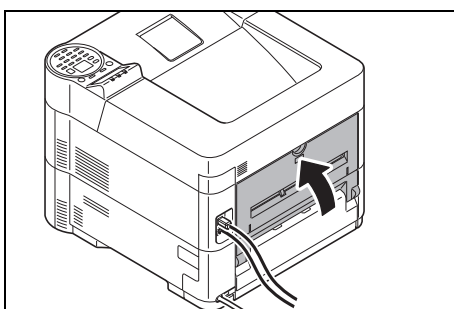

- 3 Close the rear cover.

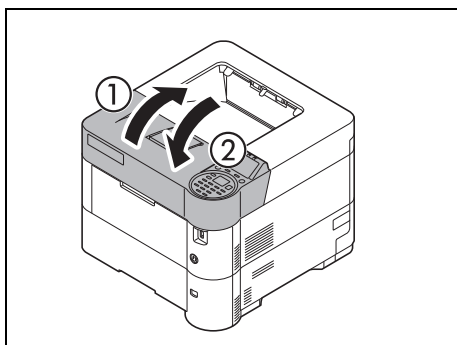

- 4 Open and close the top cover to clear the error.

Bulk Paper Feeder (Option)

Paper is jammed at the optional bulk paper feeder. Detach the bulk paper feeder from the printer by sliding with the rail away from the printer, holding the bulk paper feeder by both hands. If paper is partially fed out from the feeder's output slot, pull the paper out by hand.

Bulk Paper Feeder

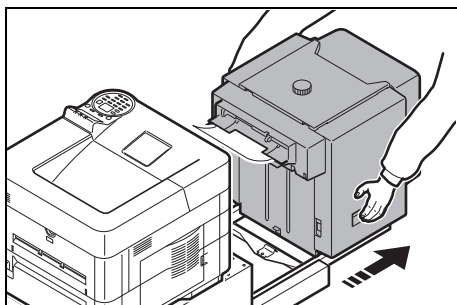

- 1 Hold the Bulk Feeder with both hands and pull out from the printer.

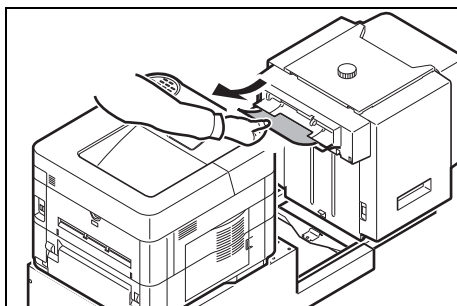

- 2 Remove the jammed paper from the connection opening between the Bulk Feeder and printer.

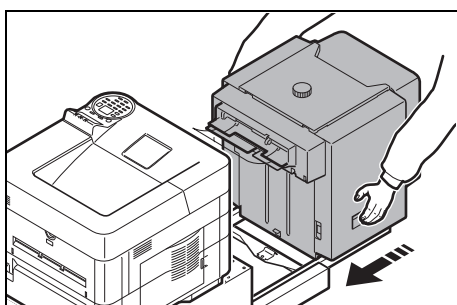

- 3 Connect the Bulk Feeder to the printer.

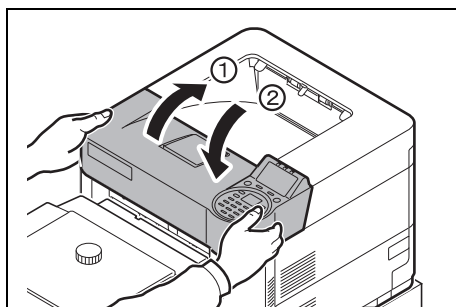

- 4** Open and close the top cover to clear the error. The printer warms up and resumes printing.

Duplex unit (when Bulk Feeder is installed)

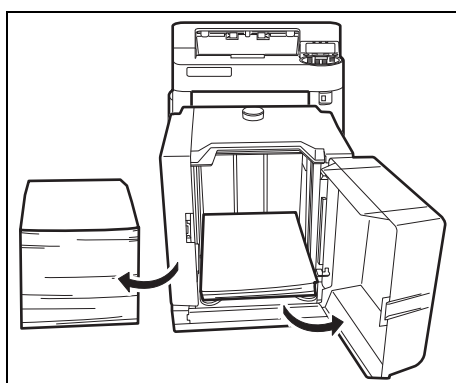

- 1** Decrease the amount of paper in the Bulk Feeder.

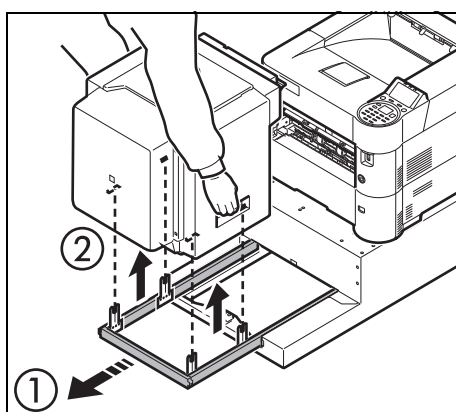

- 2** Pull the Bulk Feeder out from the printer. Hold the bulk feeder with both hands and lift to remove.

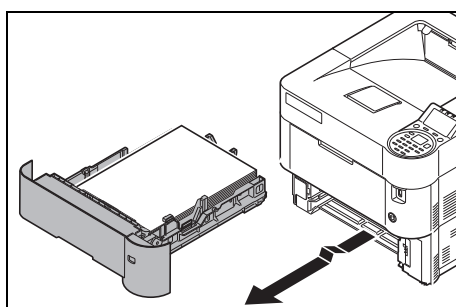

- 3** Pull out the cassette from the machine.

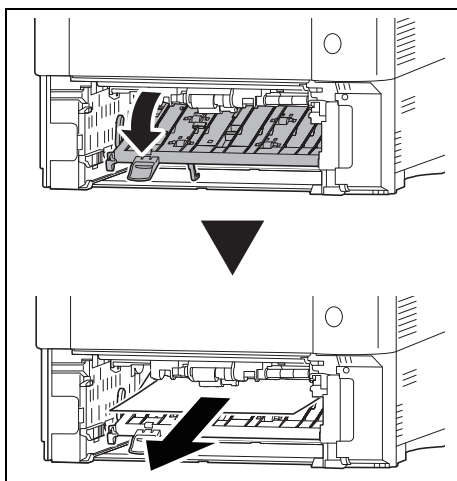

- 4** Open the duplex front cover and remove any jammed paper.

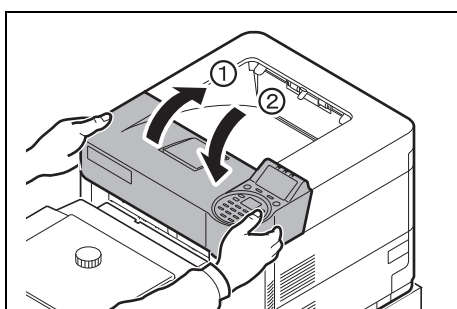

- 5** After replacing the cassette in the machine and connecting the bulk feeder to the printer, open and close the top cover to clear the error. Printing will resume after the printer warms up.

Appendix

This chapter contains explanations on the following topics:

Character Entry Method	A-2
About the Options.....	A-5
Expansion Memory Modules	A-6
General Description of Options	A-7
Paper	A-11
Specifications.....	A-21

For availability of the options, consult your service technician.

Character Entry Method

In character entry screens, use the procedure below to enter characters.

Keys Used

Use the following keys to enter characters.

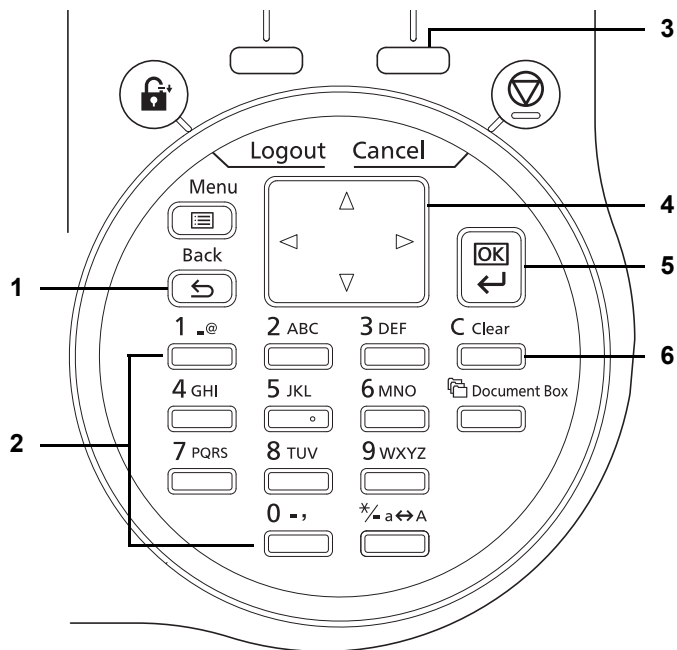

- 1 **[Back]** Key: Press this key to return to the screen from which you invoked the character entry screen.
- 2 **Numeric Keys:** Use these keys to select the character you want to enter.
- 3 **[Right Select]** Key: Press this key to select the type of characters you want to enter. (When [Text] is displayed)
- 4 **Arrow Keys:** Use these to select the entry position, or select a character from the character list.
- 5 **[OK]** Key: Press this key to finalize the entered character(s).
- 6 **[Clear]** Key: Press this key to delete the character at the cursor position. If the cursor is at the end of the line, the character to the left of it is deleted.

Selecting Type of Characters

To enter characters, the following three types are available:

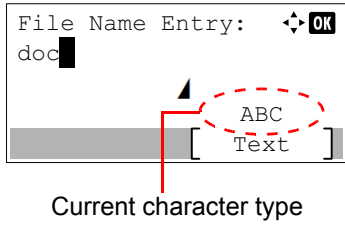

Types	Description
ABC	To enter alphabets.
123	To enter numerals.
Symbols	To enter symbols.

In a character entry screen, press [Text] ([Right Select]) to select the type of characters you want to enter.

Each time you press [Text] ([Right Select]), the character type switches as follows: ABC, 123, Symbols, ABC ...

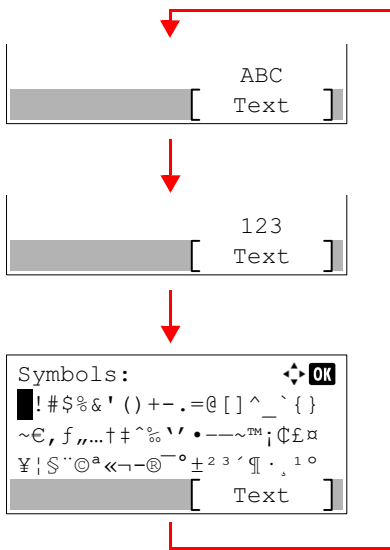











Entering Characters

After selecting a character type, use the procedure below to enter characters.

Entering Alphabets and Numerals

Referring to the table below, press the key corresponding to the character you want to enter until it is displayed.

Key	Entry mode	Available characters
1 _@ 	Alphabetic/Symbol	. @ - _ / : ~ 1
	Numeric	1
2 ABC 	Alphabetic/Symbol	a b c A B C 2
	Numeric	2
3 DEF 	Alphabetic/Symbol	d e f D E F 3
	Numeric	3
4 GHI 	Alphabetic/Symbol	g h i G H I 4
	Numeric	4

Key	Entry mode	Available characters
5 JKL 	Alphabetic/Symbol	j k l J K L 5
	Numeric	5
6 MNO 	Alphabetic/Symbol	m n o M N O 6
	Numeric	6
7 PQRS 	Alphabetic/Symbol	p q r s P Q R S 7
	Numeric	7
8 TUV 	Alphabetic/Symbol	t u v T U V 8
	Numeric	8
9 WXYZ 	Alphabetic/Symbol	w x y z W X Y Z 9
	Numeric	9
0 -, 	Alphabetic/Symbol	., - _ ' ! ? (space) 0
	Numeric	0
*/_ a ↔ A 	Alphabetic/Symbol	Switch between upper-/lowercase
	Numeric	. (period)

Characters associated with different keys can be entered consecutively. To enter a character associated with the same key after another, use cursor keys to move the cursor to the next entry position before entering it.

If you use cursor keys to move the cursor to an entry position apart from the end of the line and enter a character there, spaces are automatically entered in between.

Entering Symbols

Press [Text] ([Right Select]) to display the Symbols screen. Use cursor keys to select the symbol you want to enter and then press [OK].



Note The symbols that can be entered for the function are displayed.

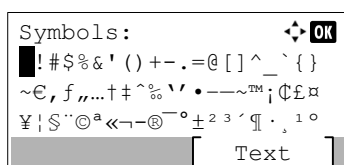

About the Options

This printer has the following options available to satisfy your printing requirements. For instructions on installing individual options, refer to the documentation included with the option. Some options are explained in the following sections.

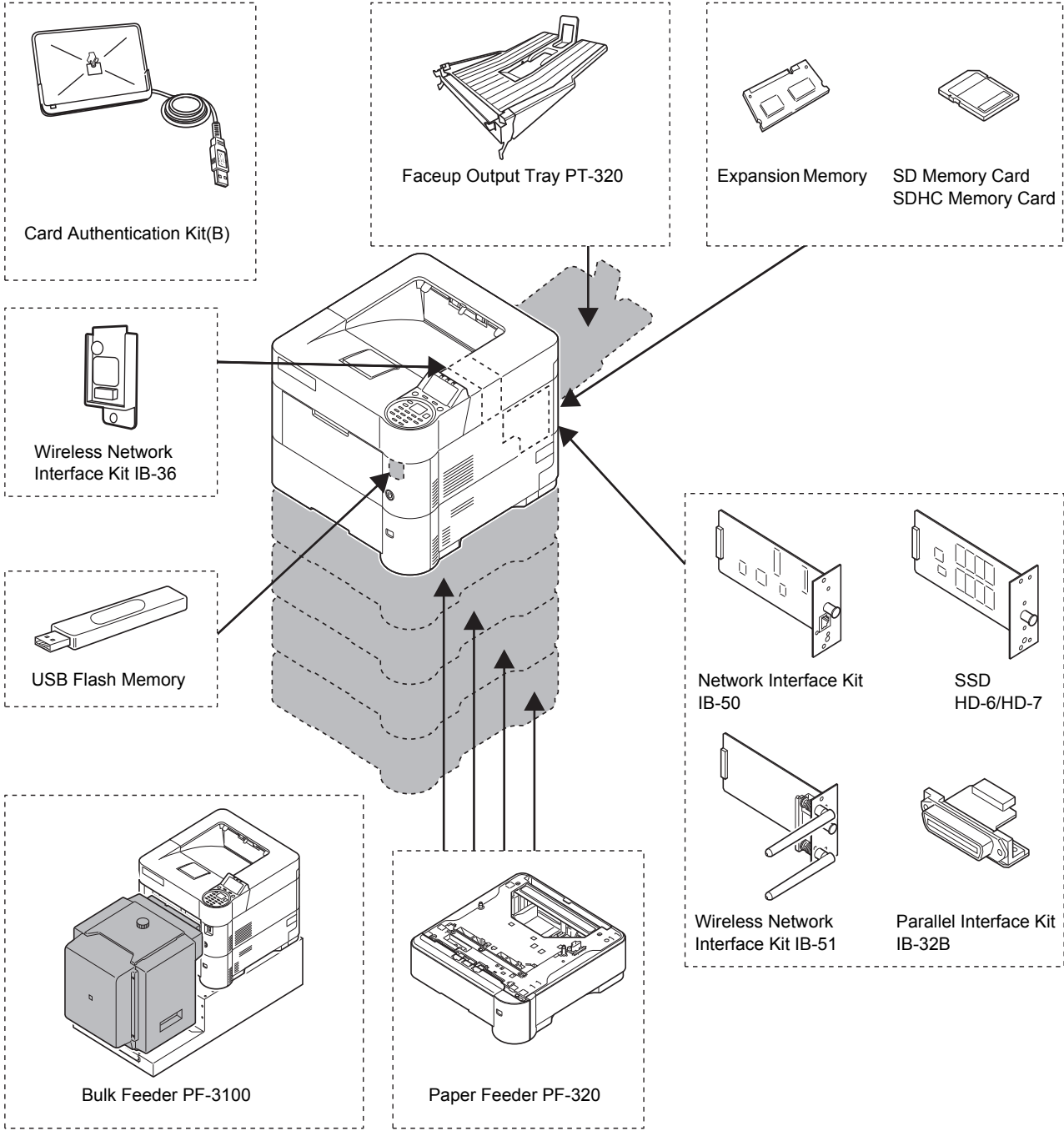

Software option

Data Security Kit(E)

UG-33

Expansion Memory Modules

The printer's main controller board has a memory slot into which you can plug in optional memory modules (dual in line memory modules). You can increase the printer's memory up to 2.5 GB by plugging in the optional memory modules.

 **Note** A 512 MB memory module is already installed at the factory. To expand memory up to 2.5 GB, install 2048 MB memory module.

Expansion Memory Modules

You can select additional memory modules from 512, 1024 or 2048 MB.

Checking Expansion Memory

After installing expansion memory, use the following method to check that it is correctly installed.

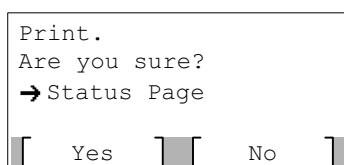

- 1** In the Report Print menu, press Δ or ∇ to select `Status Page`.
- 2** Press **[OK]**. A confirmation message is displayed.
- 3** Press **[Yes] ([Left Select])**. `Accepted.` appears and the printer prints the status page.

Check the amount of memory with the printed status page. If the memory addition has been done correctly, the total amount of memory will have increased. (The amount of memory when shipped from the factory is 256 MB.)

General Description of Options

SD/SDHC Memory Card

The printer is equipped with a slot for an SDHC memory card with a maximum size of 32 GB, and an SD memory card with a maximum size of 2 GB. An SD/SDHC memory card is useful for storing fonts, macros, and overlays.

This enables high-speed printing of multiple copies using an electric sort function. Also, you can use the Job Box functions. For details, refer to *Job Box on page 5-21*.

IMPORTANT Unencrypted data is saved on the SD/SDHC memory card. Exercise caution when saving sensitive documents.

Reading the SD/SDHC Memory Card

Once inserted in the printer's slot, the contents of the SD/SDHC memory card can be read from the operation panel or automatically when you power on or reset the printer.

PF-320 Paper Feeder

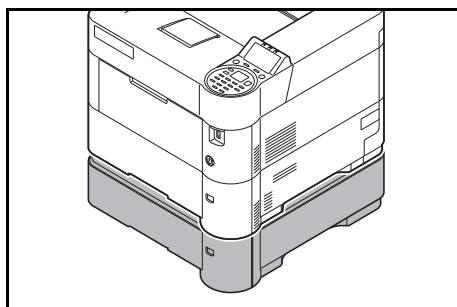

The optional paper feeder PF-320 will each hold approximately 500 sheets of paper. Up to 4 optional feeders can be added to the bottom of the printer, allowing continuous feeding of up to 2,500 sheets of paper when combined with the printer's own cassette.

IMPORTANT When you use the paper feeder, place the papers print-side down.

For details of the supported paper sizes, refer to *Selecting the Right Paper on page A-13*. For the paper type setting, refer to *Media Type (Setting the cassette paper type) on page 4-37*.

SSD (HD-6/HD-7)

With SSD installed in the printer, received data can be rasterized and stored on this SSD. This enables high-speed printing of multiple copies using an electric sort function. Also, you can use the Document Box functions. For details, refer to *Document Box on page 5-1*.

Network Interface Kit (IB-50)

The Network Interface Kit is a high-speed interface for communications speeds of 1 gigabit per second. In addition to the TCP/IP and NetBEUI supported by the machine's standard network interface, it also supports IPX/SPX and Apple Talk, so network printing becomes possible in various environments, including Windows, Macintosh, UNIX and Netware.

The installation method is the same as for SSD.

Wireless Network Interface Kit (IB-51)

This is a Wireless Network Interface Kit which supports the wireless network specifications IEEE802.11n (Max 300 Mbps) and 11 g/b.

With the utilities supplied, settings are possible for a variety of OS and network protocols.

The installation method is the same as for SSD.

Wireless Network Interface Kit (IB-36)

This is a wireless LAN Interface card which supports the wireless LAN specifications IEEE802.11n (Max 65 Mbps) and 11g/b. In addition, network printing is possible without using the wireless LAN router because Wi-Fi Direct is supported.

Parallel Interface Kit (IB-32B)

The parallel interface kit supports communications speeds up to 2 Mbps. Use a parallel printer cable when this option is used.

USB Memory

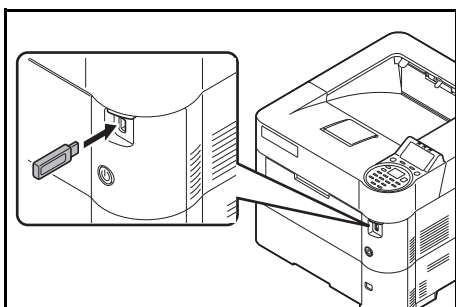

USB memory is a type of simple, highly portable flash memory that plugs into the USB memory slot. Files stored in USB memory can be printed by plugging the USB memory into the printer and then specifying the desired file names from the operation panel.

The operation panel displays the names of PDF, TIFF, JPEG, XPS and OpenXPS files.

Up to 1,000 files can be printed from USB memory. Files with names consisting of up to 255 single-byte alphanumeric characters can be printed.

Any double-byte characters included in a file name appear as corrupted text in the message list. Also, when the file is printed an error message appears and printing fails.

For information on printing PDF files stored in USB memory, refer to *USB Memory (USB memory selection)* on page 4-21.

For information on supported USB memory devices, contact your service technician.

PT-320 Faceup Output Tray (Only ECOSYS P3050dn/ECOSYS P3055dn/ECOSYS P3060dn)

Use the faceup output tray when you wish paper to be stacked with the printed side facing up (reverse order). To install the faceup output tray, perform the following procedures:

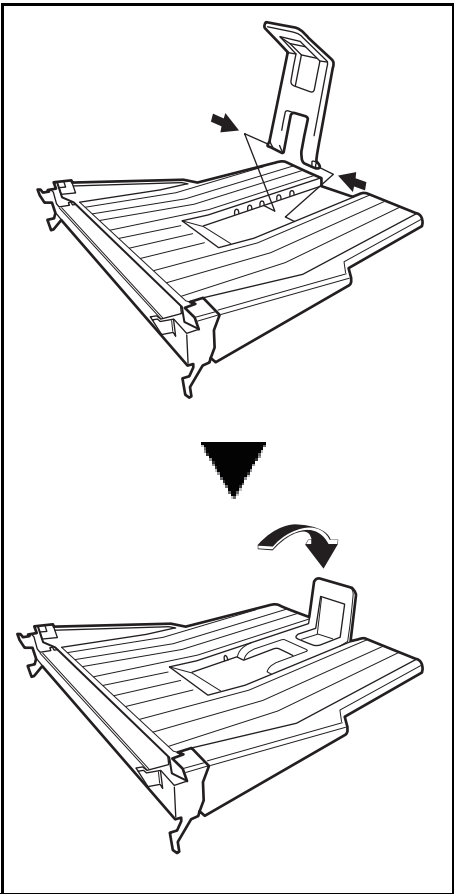

1 Install the paper stopper according to the size of paper to be used.

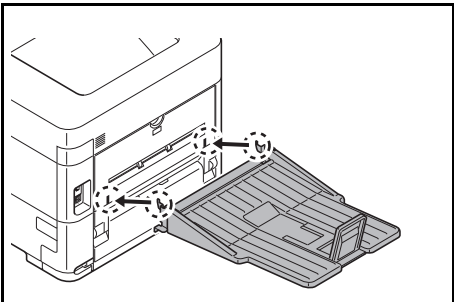

2 Install the faceup output tray on the rear of the printer.

Other Options

PF-3100 Bulk Paper Feeder

Holds approximately 2,000 sheets of 76 to 216 mm × 148 to 305 mm size paper. This bulk paper feeder can be attached to the front of the printer after the MP tray has been removed.

Data Security Kit(E)

The security kit overwrites data which is no longer necessary to make it difficult to restore it. Also, when data is stored on the SSD, it encrypts the data then writes it. It is not possible to decode (read) anything other than in normal outputs and operations, so this provides greater security should it become necessary.

Card Authentication Kit(B)

It is possible to perform user authentication with an ID card. To perform authentication with an ID card, it is necessary to first register the ID card information in the list of registered users. For the method for registration, refer to the *Card Authentication Kit (B) Operation Guide*.

USB Keyboard

A USB keyboard can be used to enter information into the text fields on the operation panel. A special mount is also available to install the keyboard on the printer. Please contact your dealer or service representative for information on keyboards that are compatible with your printer before you purchase one.

ThinPrint Option

This application allows print data to be printed directly without a print driver.

Paper

General Guidelines

The machine is designed to print on standard copier paper (the type used in ordinary dry copier machines), but it can also accept a variety of other types of paper within the limits specified below.



Note The manufacturer assumes no liability for problems that occur when paper not satisfying these requirements is used.

Selection of the right paper is important. Using the wrong paper can result in paper jams, curling, poor print quality, and paper waste, and in extreme cases can damage the machine. The guidelines given below will increase the productivity of your office by ensuring efficient, trouble-free printing and reducing wear and tear on the machine.

Paper Availability

Most types of paper are compatible with a variety of machines. Paper intended for xerographic copiers can also be used with the machine.

There are three general grades of paper: *economy*, *standard*, and *premium*. The most significant difference between grades is the ease with which they pass through the machine. This is affected by the *smoothness*, *size*, and *moisture content* of the paper, and the way in which the paper is cut. The higher the grade of paper you use, the less risk there will be of paper jams and other problems, and the higher the level of quality your printed output will reflect.

Differences between papers from different suppliers can also affect the machine's performance. A high-quality printer cannot produce high-quality results when the wrong paper is used. Low-priced paper is not economical in the long run if it causes printing problems.

The recommended basis weight is:

- Cassette: 60 to 120 g/m²
- MP tray: 60 to 220 g/m², 209.5 g/m² (Cardstock)
- PF-320: 60 to 120 g/m²
- PF-3100: 60 to 220 g/m²

Paper Specifications

The following table summarizes the basic paper specifications. Details are given on the following pages.

Item	Specification
Weight	Cassette, PF-320: 60 to 120 g/m ² MP Tray, PF-3100: 60 to 220 g/m ² , 209.5 g/m ² (Cardstock)
Dimensions	Refer to <i>Paper Sizes on page A-13</i>
Dimensional accuracy	±0.7 mm (±0.0276 inches)
Squareness of corners	90° ±0.2°
Moisture content	4 % to 6 %
Pulp content	80 % or more

Minimum and Maximum Paper Sizes

The minimum and maximum paper sizes are as follows. For non standard paper such as transparency, labels, vellum, cardstock, envelope and thick, the MP (Multi-Purpose) tray must be used. For information on how to set paper sizes, refer to *MP Tray Set. (MP tray settings)* on page 4-30.

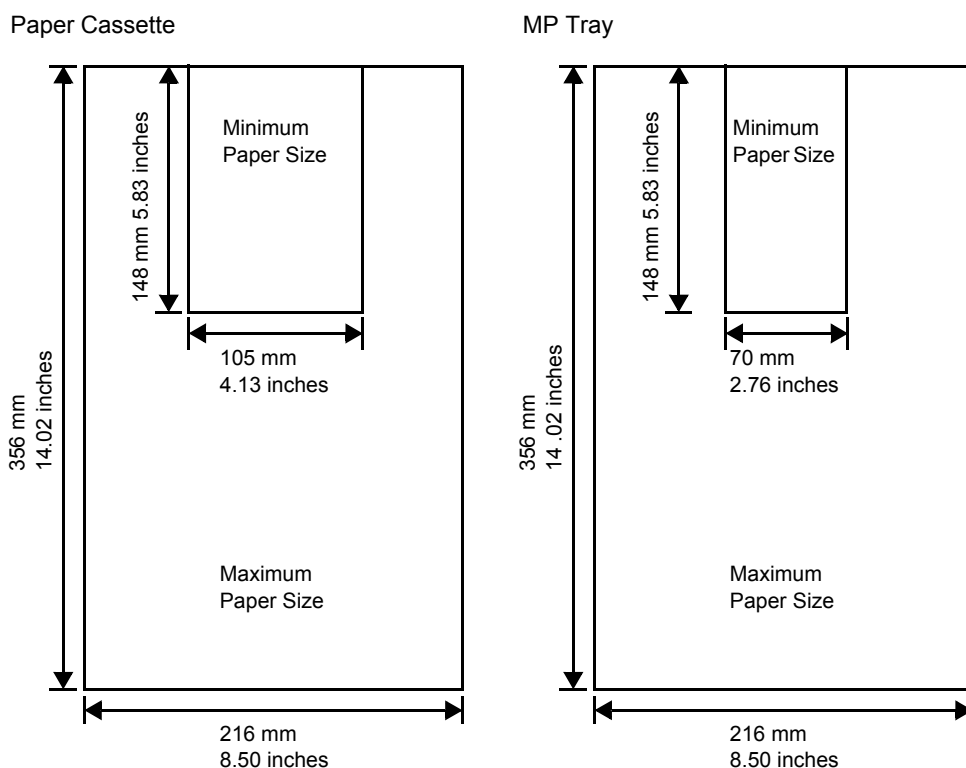

 **Note** On ECOSYS P3045dn, the minimum size of Paper Cassette is 140 × 210 mm (5.51 × 8.27 inches). On the optional paper feeder (PF-320), the minimum size is 92 × 162 mm (3.62 × 6.38 inches) and the maximum size is 216 × 356 mm (8.50 × 14 inches).

Recommended Paper

The following products are recommended for use with the printer for optimum performance.

Size	Product	Weight
Letter, Legal	International Paper Hammermill Tidal MP	75 g/m ² (20 lb)
A4	Nautilus ReFresh TRIOTEC	80 g/m ²

Selecting the Right Paper

This section describes the guidelines for selecting paper.

Condition

Avoid using paper that is bent at the edges, curled, dirty, torn, embossed, or contaminated with lint, clay, or paper shreds.

Use of paper in these conditions can lead to illegible printing and paper jams, and can shorten the life of the machine. In particular, avoid using paper with a surface coating or other surface treatment. Paper should have as smooth and even a surface as possible.

Composition

Do not use paper that has been coated or surface-treated and contains plastic or carbon. The heat of fusing can cause such paper to give off harmful fumes.

Bond paper should contain at least 80 % pulp. Not more than 20 % of the total paper content should consist of cotton or other fibers.

Paper Sizes

Cassettes and the *MP tray* are available for the paper sizes listed in the table below. For details, including the paper sizes for the paper feeder (Optional paper feeder PF-320) refer to *Setting the standard paper size on page 4-32*.

The dimensional tolerances are ± 0.7 mm (± 0.0276 inches) for the length and width. The angle at the corners must be $90^\circ \pm 0.2^\circ$.

Yes: Can be stored No: Cannot be stored

Paper Size	Size	Cassette (ECOSYS P3045dn)	Cassette (ECOSYS P3050dn/ ECOSYS P3055dn/ ECOSYS P3060dn)	Cassette (PF-320)	Bulk Paper Feeder (PF-3100)	MP Tray
Envelope Monarch	3.88 × 7.50 inches	No	No	Yes	Yes	Yes
Envelope #10	4.13 × 9.50 inches	No	No	Yes	Yes	Yes
Envelope DL	110 × 220 mm	Yes	Yes	Yes	Yes	Yes
Envelope C5	162 × 229 mm	Yes	Yes	Yes	Yes	Yes
Executive	7.25 × 10.50 inches	Yes	Yes	Yes	Yes	Yes
Letter	8.5 × 11 inches	Yes	Yes	Yes	Yes	Yes
Legal	8.5 × 14 inches	Yes	Yes	Yes	No	Yes
A4	210 × 297 mm	Yes	Yes	Yes	Yes	Yes
B5(JIS)	182 × 257 mm	Yes	Yes	Yes	Yes	Yes
A5-R	148 × 210 mm	Yes	Yes	Yes	Yes	Yes
A5	210 × 148 mm	Yes	Yes	No	No	Yes
A6	105 × 148 mm	No	Yes	No	Yes [†]	Yes
B6	128 × 182 mm	No	Yes	Yes	Yes	Yes
Envelope #9	3.88 × 8.88 inches	No	No	Yes	Yes	Yes
Envelope #6-3/4	3.63 × 6.50 inches	No	No	Yes	Yes [†]	Yes
ISO B5	176 × 250 mm	Yes	Yes	Yes	Yes	Yes
Hagaki	100 × 148 mm	No	No	No	Yes [†]	Yes

Paper Size	Size	Cassette (ECOSYS P3045dn)	Cassette (ECOSYS P3050dn/ ECOSYS P3055dn/ ECOSYS P3060dn)	Cassette (PF-320)	Bulk Paper Feeder (PF-3100)	MP Tray
OufukuHagaki	148 × 200 mm	No	Yes	Yes	Yes	Yes
Oficio II	8.50 × 13 inches	Yes	Yes	Yes	No	Yes
216 × 340 mm	216 × 340 mm	Yes	Yes	Yes	No	Yes
16 kai	197 × 273 mm	Yes	Yes	Yes	Yes	Yes
Statement	5.5 × 8.50 inches	Yes	Yes	Yes	Yes	Yes
Folio	210 × 330 mm	Yes	Yes	Yes	No	Yes
Youkei 4	105 × 235 mm	No	No	Yes	Yes	Yes
Youkei 2	114 × 162 mm	No	No	Yes	Yes [†]	Yes
Custom	Cassette (ECOSYS P3045dn): 140 to 216 mm × 210 to 356 mm (5.51 to 8.50 inches × 8.27 to 14.02 inches) Cassette (ECOSYS P3050dn/ECOSYS P3055dn/ECOSYS P3060dn): 105 to 216 mm × 148 to 356 mm (4.13 to 8.50 inches × 5.83 to 14.02 inches) Cassette (PF-320): 92 to 216 mm × 162 to 356 mm (3.62 to 8.50 inches × 6.38 to 14.02 inches) MP Tray: 70 to 216 mm × 148 to 356 mm (2.76 to 8.50 inches × 5.83 to 14.02 inches) Bulk Paper Feeder (PF-3100): 76 to 216 mm × 148 to 305 mm (2.99 to 8.50 inches × 5.83 to 12.01 inches)					

[†] The paper size can be specified using the printer driver. However, feeding paper depends on the paper type.

Smoothness

The paper should have a smooth, uncoated surface. Paper with a rough or sandy surface can cause voids in the printed output. Paper that is too smooth can cause multiple feeding and fogging problems. (Fogging is a gray background effect.)

Basis Weight

Basis weight is the weight of paper expressed in grams per square meter (g/m²). Paper that is too heavy or too light may cause feed errors or paper jams as well as premature wear of the product. Uneven weight of paper, namely uneven paper thickness may cause multiple-sheet feeding or print quality problems such as blurring because of poor toner fusing.

The recommended basis weight is between 60 and 120 g/m² (16 and 32 lb/ream) for the cassette and between 60 and 220 g/m² (16 and 59 lb/ream) for the MP tray.

Paper Weight Equivalence Table

The paper weight is listed in pounds (lb) and metric grams per square meter (g/m²). The shaded part indicates the standard weight.

U. S. Bond Weight (lb)	Europe Metric Weight (g/m ²)	U. S. Bond Weight (lb)	Europe Metric Weight (g/m ²)
16	60	32	120
17	64	34	128
20	75	36	135
21	80	39	148

U. S. Bond Weight (lb)	Europe Metric Weight (g/m ²)	U. S. Bond Weight (lb)	Europe Metric Weight (g/m ²)
22	81	42	157
24	90	43	163
27	100	47	176
28	105	53	199

Moisture Content

Moisture content is defined as the percent ratio of moisture to the dry mass of the paper. Moisture can affect the paper’s appearance, feed ability, curl, electrostatic properties, and toner fusing characteristics.

The moisture content of the paper varies with the relative humidity in the room. When the relative humidity is high and the paper absorbs moisture, the paper edges expand, becoming wavy in appearance. When the relative humidity is low and the paper loses moisture, the edges shrink and tighten, and print contrast may suffer.

Wavy or tight edges can cause jams and alignment anomalies.

To ensure correct moisture content, it is important to store the paper in a controlled environment. Some tips on moisture control are:

- Store paper in a cool, dry location.
- Keep the paper in its wrapping as long as possible. Re-wrap paper that is not in use.
- Store paper in its original carton. Place a pallet etc. under the carton to separate it from the floor.
- After removing paper from storage, let it stand in the same room as the machine for 48 hours before use.
- Avoid leaving paper where it is exposed to heat, sunlight, or damp.

 **Note** When using coated paper, be aware that the sheets will stick together in a very humid environment.

Paper Grain

When paper is manufactured, it is cut into sheets with the grain running parallel to the length (long grain) or parallel to the width (short grain). Short grain paper can cause feeding problems in the machine. All paper used in the machine should be long grain.

Other Paper Properties

Porosity: Indicates the density of paper fiber.

Stiffness: Limp paper may buckle in the machine, resulting in paper jams.

Curl: Most paper naturally tends to curl one way if left unpacked.

Electrostatic discharge: During the printing process the paper is electrostatically charged to attract the toner. The paper must be able to release this charge so that printed sheets do not cling together in the *Output Tray*.

Whiteness: The contrast of the printed page depends on the whiteness of the paper. Whiter paper provides a sharper, brighter appearance.

Quality control: Uneven sheet size, corners that are not square, ragged edges, welded (uncut) sheets, and crushed edges and corners can cause the machine to malfunction in various ways. A quality paper supplier should take considerable care to ensure that these problems do not occur.

Packaging: Paper should be packed in a sturdy carton to protect it from damage during transport. Quality paper obtained from a reputable supplier is usually correctly packaged.

 **Note** You might see the printer emitting steam in the area around the top tray if you use damp paper, but it is safe to continue printing.

Special Paper

The following types of special paper can be used:

Paper Type to be Used	Paper Type to be Selected
Overhead projector transparencies	Transparency
Rough paper	Rough
Thin paper	Vellum
Label	Labels
Recycled paper	Recycled
Preprinted paper	Preprinted
Bond paper	Bond
Postcards	Cardstock
Colored paper	Color
Prepunched paper	Prepunched
Letterhead	Letterhead
Envelopes	Envelope
Thick paper	Thick
High-quality paper	High Quality
Custom	Custom 1~8

Use paper that is sold specifically for use with copiers or printers (heat-fusing type). When using labels, thin paper, postcards, or thick paper, feed the paper from the *MP tray*. For details, refer to *MP Tray Set. (MP tray settings)* on page 4-30.

Since the composition and quality of special paper vary considerably, special paper is more likely than white bond paper to give trouble during printing. No liability will be assumed if moisture and so forth given off during printing on special paper causes harm to the machine or operator.

 **Note** Before purchasing any type of special paper, test a sample on the machine and check that printing quality is satisfactory.

Transparency

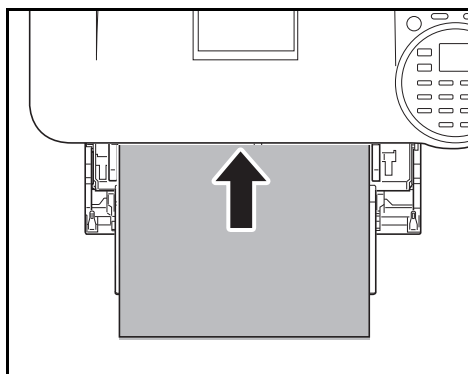

To prevent printing problems, feed transparencies into the printer one sheet at a time from the *MP tray*. Always load the transparencies vertically (with the long edge towards the printer).

If the transparencies have rough edges on the back, it may cause a paper jam. Remove the rough edges, reverse the sides, feed the sheet from the opposite edge, or flip the sheet over.

When unloading transparencies (e.g., for clearing jams), hold them carefully by the edges to avoid leaving fingerprints on them.

Labels

Labels must be fed from the *MP tray*.

The basic rule for printing on adhesive labels is that the adhesive must never come into contact with any part of the machine. Adhesive paper sticking to the drum or rollers will damage the machine.

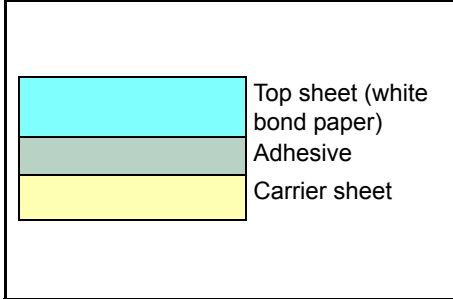

Label paper has a structure comprising of three layers, as shown in the diagram. The top sheet is printed on. The adhesive layer consists of pressure-sensitive adhesives. The carrier sheet (also called the linear or backing sheet) holds the labels until used. Due to the complexity of its composition, adhesive-backed label paper is particularly likely to give printing problems.

Adhesive label paper must be entirely covered by its top sheet, with no spaces between the individual labels. Labels with spaces in between are liable to peel off, causing serious paper jam problems.

Some label paper is manufactured with an extra margin of top sheet around the edge. Do not remove the extra top sheet from the carrier sheet until after printing is finished.

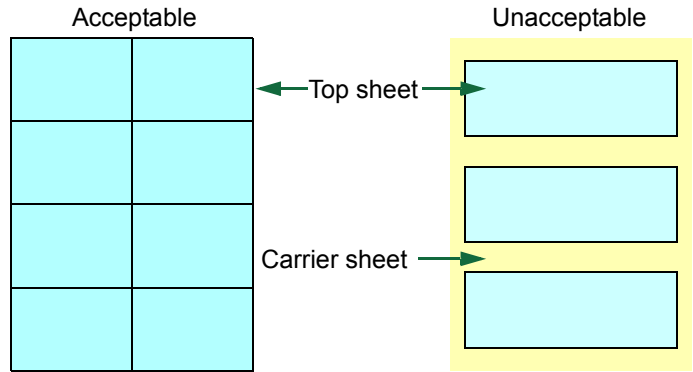

The table below lists the specifications for adhesive label paper.

Item	Specification
Weight of top sheet	44 to 74 g/m ² (12 to 20 lb/ream)
Basis weight	104 to 151 g/m ² (28 to 40 lb/ream)
Thickness of top sheet	0.086 to 0.107 mm (3.9 to 4.2 mils)
Composite thickness	0.115 to 0.145 mm (4.5 to 5.7 mils)
Moisture content	4 to 6 % (composite)

Postcards

Fan the stack of postcards and align the edges before loading them in the MP tray. Make sure the postcards you are going to set are not curled. Feeding curled postcards may cause paper jams.

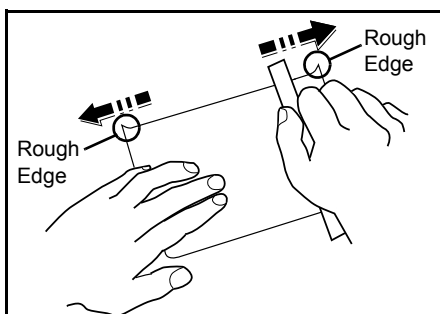

Some postcards have rough edges on the back (those are created when the paper is cut). In this case, put the postcards on a flat place and rub the edges with, for example, a ruler to smooth them.

Envelopes

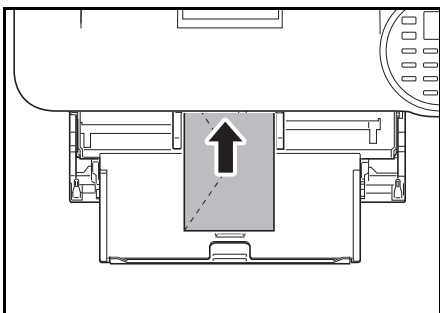

Envelopes should be fed from the MP tray with the print-side up or the optional paper feeder (PF-320) with the print-side down.



Note Do not load paper above the load limits located on the paper width guide.

Since the composition of an envelope is more complex than that of ordinary paper, it is not always possible to ensure consistent printing quality over the entire envelope surface.

Normally, envelopes have a diagonal grain direction. Refer to *Paper Grain on page A-15*. This direction can easily cause wrinkles and creases when envelopes pass through the printer. Before purchasing envelopes, make a test print to check whether the printer accepts the envelope.

- Do not use envelopes that have an encapsulated liquid adhesive.
- Avoid a long printing session for envelopes only. Extended envelope printing can cause premature printer wear.
- If jams occur, try setting a lesser number of envelopes on the MP tray.
- To avoid jams caused by curled envelopes, stack no more than 5 printed envelopes on the top tray.

Thick Paper

Fan the stack of paper and align the edges before loading them in the MP tray. Some types of paper have rough edges on the back (those are created when the paper is cut). In this case, put the paper on a flat place and rub the edges once or twice with, for example, a ruler to smooth them. Feeding rough edged paper may cause paper jams.

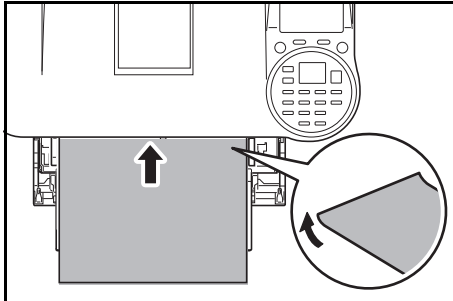

 **Note** If the paper jams even after you smooth it out, load the paper in the *MP tray* with the leading edge rose up a few millimeters as shown in the illustration.

Colored Paper

Colored paper should satisfy the same conditions as white bond paper, refer to *Paper Specifications on page A-11*. In addition, the pigments used in the paper must be able to withstand the heat of fusing during the printing process (up to 200 °C or 392 °F).

Preprinted Paper

Preprinted paper should satisfy the same conditions as white bond paper, refer to *Paper Specifications on page A-11*. The preprinted ink must be able to withstand the heat of fusing during the printing process, and must not be affected by silicone oil. Do not use paper with any kind of surface treatment, such as the type of paper commonly used for calendars.

Recycled Paper

Select recycled paper that meets the same specifications as the white bond paper except for whiteness, refer to *Paper Specifications on page A-11*.



Note Before purchasing recycled paper, test a sample on the machine and check that the printing quality is satisfactory.

Paper Type

The printer is capable of printing under the optimum setting for the type of paper being used.

Setting the paper type for the paper source from the printer's operation panel will cause the printer to automatically select the paper source and print in the mode best suited to that type of paper.

A different paper type setting can be made for each paper source including the MP tray. Not only can preset paper types be selected, but it is also possible for you to define and select customized paper types. Refer to *Media Type Set. (Paper type settings)* on page 4-39. The following types of paper can be used.

Yes: Can be stored No: Cannot be stored

Paper Type	Paper Source				
	MP Tray / Optional Bulk Paper Feeder PF-3100	Paper Cassette	Optional Paper Feeder PF-320	Paper Weight	Duplex Path
Plain	Yes	Yes	Yes	Normal 2	Yes
Transparency	Yes	No	No	Extra Heavy	No
Preprinted	Yes	Yes	Yes	Normal 2	Yes
Labels	Yes	No	No	Heavy 1	No
Bond	Yes	Yes	Yes	Normal 3	Yes
Recycled	Yes	Yes	Yes	Normal 2	Yes
Vellum	Yes	No	No	Light	No
Rough	Yes	Yes	Yes	Normal 2	Yes
Letterhead	Yes	Yes	Yes	Normal 2	Yes
Color	Yes	Yes	Yes	Normal 2	Yes
Prepunched	Yes	Yes	Yes	Normal 2	Yes
Envelope	Yes	No	Yes	Heavy 3	No
Cardstock	Yes	No	No	Heavy 3	No
Thick	Yes	No	No	Heavy 3	No
High Quality	Yes	Yes	Yes	Normal 2	Yes
Custom 1 (to 8) [†]	Yes	Yes	Yes	Normal 2	Yes

[†] This is a paper type defined and registered by the user. Up to eight types of user settings may be defined. For details, refer to *Media Type Set. (Paper type settings)* on page 4-39.

Specifications



Note Specifications are subject to change without notice.

Machine

Item	Description					
	ECOSYS P3045dn	ECOSYS P3050dn	ECOSYS P3055dn	ECOSYS P3060dn		
Type	Desktop					
Printing Method	Electrophotography by semiconductor, single drum system					
Paper Weight	Cassette	60 to 120 g/m ²				
	MP Tray	60 to 220 g/m ² , 209.5 g/m ² (Cardstock)				
Paper Types	Cassette	Plain, Preprinted, Bond, Recycled, Rough, Letterhead, Color, Prepunched, High Quality, and CUSTOM 1 (to 8)				
	MP Tray	Plain, Transparency, Preprinted, Labels, Bond, Recycled, Vellum, Rough, Letterhead, Color, Prepunched, Envelope, Cardstock, Thick, High Quality, and CUSTOM 1 (to 8)				
Paper Sizes	Cassette	Envelope DL, Envelope C5, Executive, 8 1/2 × 11"(Letter), 8 1/2 × 14"(Legal), A4, B5, A5, A5-R, ISO B5, Oficio II, 216 × 340 mm, 16K, Statement, Folio, and Custom	Envelope DL, Envelope C5, Executive, 8 1/2 × 11"(Letter), 8 1/2 × 14"(Legal), A4, B5, A5, A5-R, A6, B6, ISO B5, Ofufuku Hagaki, Oficio II, 216 × 340 mm, 16K, Statement, Folio, and Custom			
	MP Tray	Envelope Monarch, Envelope #10, Envelope DL, Envelope C5, Executive, 8 1/2 × 11"(Letter), 8 1/2 × 14"(Legal), A4, B5, A5, A5-R, A6, B6, Envelope #9, Envelope #6, ISO B5, Hagaki, Ofufuku Hagaki, Oficio II, 216 × 340 mm, 16K, Statement, Folio, Youkei 2, Youkei 4, and Custom				
Magnification ratio	20 to 500%, 1% increments					
Printing Speeds	Simplex	A4: 45 ppm B5: 36 ppm A5: 23 ppm Letter: 47 ppm Legal: 38 ppm	A4: 50 ppm B5: 40 ppm A5: 27 ppm A6: 27 ppm Letter: 52 ppm Legal: 42 ppm	A4: 55 ppm B5: 44 ppm A5: 29 ppm A6: 29 ppm Letter: 57 ppm Legal: 46 ppm	A4: 60 ppm B5: 48 ppm A5: 32 ppm A6: 32 ppm Letter: 62 ppm Legal: 50 ppm	
	Duplex	A4: 22.5 ppm B5: 18 ppm A5: 11.5 ppm Letter: 23.5 ppm Legal: 19 ppm	A4: 36 ppm B5: 28 ppm A5: 19 ppm Letter: 37 ppm Legal: 21 ppm	A4: 39.5 ppm B5: 20.3 ppm A5: 20.3 ppm Letter: 40.5 ppm Legal: 23 ppm	A4: 42 ppm B5: 34 ppm A5: 23 ppm Letter: 44 ppm Legal: 25 ppm	
First Print Time (A4, feed from Cassette)	5.9 seconds or less	6.2 seconds or less	6.6 seconds or less	4.9 seconds or less		

Item		Description			
		ECOSYS P3045dn	ECOSYS P3050dn	ECOSYS P3055dn	ECOSYS P3060dn
Warm-up Time (23°C, 60%RH)	Power On	15 seconds or less	20 seconds or less	25 seconds or less	25 seconds or less
	Sleep†	15 seconds or less	20 seconds or less	25 seconds or less	25 seconds or less
Paper Capacity	Cassette	500 sheets (80 g/m ²)			
	MP Tray	100 sheets (80 g/m ²)			
Output Tray Capacity	Top Tray	250 sheets	500 sheets		
	Face-up Tray	–	250 sheets		
Continuous printing		1 to 999 sheets			
Resolution		Fine 1200 mode, Fast 1200 mode, 600 dpi, 300 dpi			
Operation Environment	Temperature	10 to 32.5 °C (50 to 90.5 °F)			
	Relative Humidity	15 to 80 %			
	Altitude	3,500 m (8,202 feet) maximum			
	Illumination	1,500 lux maximum			
Controller		ARM Cortex-A9, ARM Cortex-M3			
Operating Systems		Windows XP, Windows Server 2003, Windows Vista, Windows 7, Windows 8, Windows 8.1, Windows 10, Windows Server 2008/R2, Windows Server 2012/R2, Mac OS 10.5 or later			
Interface	Standard	USB Interface Connector: 1 USB Host: 2 eKUIO slot:1			
	Option	HD-6/HD-7, IB-50, IB-51, IB-36, IB-32B			
PDL		PRESCRIBE			
Emulation		PCL6 (PCL5e, PCL-XL), KPDL3 (PostScript3 compatible), XPS, Open XPS, TIFF/JPEG Direct Print, IBM Proprinter, LQ-850, Line Printer			
Memory	Standard	512 MB			
	Maximum	2.5 GB			
Dimensions (W × D × H)		380 × 410 × 285 mm 15 × 16 9/64 × 11-1/4"	380 × 410 × 320 mm 15 × 16 9/64 × 12 5/8"		
Weight		Approx. 14.5 kg (32 lbs)	Approx. 15.5 kg (34.2 lbs)		
Power Requirement		120 V, 60 Hz, 9.5 A 220-240 V, 50 Hz/ 60 Hz, 5.4 A	120 V, 60 Hz, 10.0 A 220-240 V, 50 Hz/60 Hz, 5.6 A		

Item		Description			
		ECOSYS P3045dn	ECOSYS P3050dn	ECOSYS P3055dn	ECOSYS P3060dn
Power Consumption (Standard)	Maximum	1148 W (U.S.A./ Canada) 1218 W (European countries)	1153 W (U.S.A./ Canada) 1222 W (European countries)	1164 W (U.S.A./ Canada) 1238 W (European countries)	1164 W (U.S.A./ Canada) 1238 W (European countries)
	During Printing	664 W (U.S.A./ Canada) 594 W (European countries)	700 W (U.S.A./ Canada) 636 W (European countries)	753 W (U.S.A./ Canada) 675 W (European countries)	789 W (U.S.A./ Canada) 684 W (European countries)
	During Standby	10 W (U.S.A./ Canada) 10 W (European countries)	11 W (U.S.A./ Canada) 11 W (European countries)	11 W (U.S.A./ Canada) 11 W (European countries)	11 W (U.S.A./ Canada) 11 W (European countries)
	Sleep Mode [†]	0.8 W (U.S.A./ Canada) 0.9 W (European countries)	0.8 W (U.S.A./ Canada) 0.9 W (European countries)	0.8 W (U.S.A./ Canada) 0.9 W (European countries)	0.8 W (U.S.A./ Canada) 0.8 W (European countries)
	Power Off	0.05 W (U.S.A./ Canada) 0.08 W (European countries)	0.05 W (U.S.A./ Canada) 0.07 W (European countries)	0.05 W (U.S.A./ Canada) 0.07 W (European countries)	0.05 W (U.S.A./ Canada) 0.08 W (European countries)
Power Consumption (With options)	Maximum	1180 W (U.S.A./ Canada) 1256 W (European countries)	1185 W (U.S.A./ Canada) 1256 W (European countries)	1204 W (U.S.A./ Canada) 1275 W (European countries)	1204 W (U.S.A./ Canada) 1275 W (European countries)
	During Printing	704 W (U.S.A./ Canada) 617 W (European countries)	758 W (U.S.A./ Canada) 685 W (European countries)	801 W (U.S.A./ Canada) 722 W (European countries)	835 W (U.S.A./ Canada) 731 W (European countries)
	During Standby	16 W (U.S.A./ Canada) 17 W (European countries)	17 W (U.S.A./ Canada) 17 W (European countries)	17 W (U.S.A./ Canada) 17 W (European countries)	17 W (U.S.A./ Canada) 17 W (European countries)
	Sleep Mode [†]	0.7 W (U.S.A./ Canada) 0.7 W (European countries)	0.7 W (U.S.A./ Canada) 0.7 W (European countries)	0.7 W (U.S.A./ Canada) 0.8 W (European countries)	0.7 W (U.S.A./ Canada) 0.8 W (European countries)
	Power Off	0.05 W (U.S.A./ Canada) 0.08 W (European countries)	0.05 W (U.S.A./ Canada) 0.07 W (European countries)	0.05 W (U.S.A./ Canada) 0.08 W (European countries)	0.05 W (U.S.A./ Canada) 0.08 W (European countries)
The power consumption of the product in networked standby (If all network ports are connected.)		1.0 W			

Item	Description			
	ECOSYS P3045dn	ECOSYS P3050dn	ECOSYS P3055dn	ECOSYS P3060dn
Option	Expanded memory, Paper Feeder (500-sheet × 4), SSD (HD-6/HD-7), SD Card, Network Interface Kit (IB-50), Wireless Network Interface Kit (IB-51), Wireless Network Interface Kit (IB-36), Parallel Interface Kit (IB-32B), Bulk Paper Feeder (PF-3100)	Expanded memory, Paper Feeder (500-sheet × 4), SSD (HD-6/HD-7), SD Card, Network Interface Kit (IB-50), Wireless Network Interface Kit (IB-51), Wireless Network Interface Kit (IB-36), Parallel Interface Kit (IB-32B), Bulk Paper Feeder (PF-3100), Faceup Output Tray (PT-320)		

† The value is at Energy Saver mode (default).

Paper Feeder (PF-320) (Option)

Item	Description
The maximum number of paper cassettes	4
Paper size	Envelope Monarch, Envelope #10, Envelope DL, Envelope C5, Executive, 8 1/2 × 11"(Letter), 8 1/2 × 14"(Legal), A4, B5, A5, B6, Envelope #9, Envelope #6, ISO B5, Oufuku Hagaki, Oficio II, 216 × 340 mm, 16K, Statement, Folio, Youkei 2, Youkei 4, and Custom
Paper type	Plain, Preprinted, Bond, Recycled, Rough, Letterhead, Color, Prepunched, Envelope, High Quality, and CUSTOM 1 (to 8)
Paper capacity	500 sheets (80 g/m ²)
Dimensions (W × D × H)	380 × 410 × 121 mm 15 × 16 1/8 × 4 3/4"
Weight	3.8 kg or less (8.4 lbs or less)

Bulk Paper Feeder (PF-3100) (Option)

Item	Description
Paper size	Envelope Monarch, Envelope #10, Envelope DL, Envelope C5, Executive, Letter, A4, B5, A5, A6, B6, Envelope #9, Envelope #6, ISO B5, Custom, Hagaki, Oufuku Hagaki, 16K, Statement, Youkei 2 and Youkei 4
Paper type	Plain, Transparency, Preprinted, Labels, Bond, Recycled, Vellum, Rough, Letterhead, Color, Prepunched, Envelope, Cardstock, Thick, High Quality, and CUSTOM 1 (to 8)
Paper capacity	2,000 sheets (75 g/m ²)
Noise (Lwad)	ECOSYS P3045dn: 70 dB(A) ECOSYS P3050dn: 71 dB(A) ECOSYS P3055dn: 72 dB(A) ECOSYS P3060dn: 72 dB(A) (At feeding the standard size paper)
Dimensions (W × D × H)	345 × 420 × 371 mm 13 37/64 × 13 17/32 × 14 39/64"
Weight	7.5 kg or less (16.54 lbs or less)

SSD (HD-6/HD-7) (Option)

Item	Description	
	HD-6	HD-7
Capacity	32 GB	128 GB
Power supply	From the machine	

Network Interface Kit (IB-50) (Option)

Item	Description	
CPU	SoC 88F6180	
RAM	64 MBytes	
Flash ROM	16 MBytes	
Connectors	10BASE-T / 100BASE-TX / 1000BASE-T	
Printer interface	eKUIO (5.0V)	
Operating system	Windows XP (32bit/64bit) / Vista (32bit/64bit) / 7 (32bit/64bit) / Server 2003 (32bit/64bit) / Server 2008 (32bit/64bit) NetWare 3.x. / 4.x. / 5.x. / 6.x MacOS 9.x / Mac OS X (PowerPC: Ver 10.3.x-Ver 10.5.5 / Intel: Ver 10.4.4-Ver 10.7.x) UNIX	
Network protocols	IPv6	Apple Bonjour Compatible, DHCPv6, DNSv6, FTP, FTPS, HTTP, HTTPS, ICMPv6, IKEv1, IPP, IPPS, Kerberos, LDAP, LPD, POP3, RawPort, SLP, SMTP, SNMP, SNMPv1/v2c/v3, SNTP, ThinPrint
	IPv4	Apple Bonjour Compatible, BOOTP, DHCP, DNS, FTP, FTPS, HTTP, HTTPS, ICMP, IPP, IPPS, KCP, Kerberos, LDAP, LPD, NetBIOS over TCP/IP, POP3, POP3 over SSL, RawPort, SLP, SMTP, SNMP, SNMPv1/v2c/v3, SNTP, ThinPrint, WINS
	Other	AppleTalk, IPX/SPX, LLTD, NetBEUI, NetWare (NDS/Bindery)
Security protocols	EAP-TLS, EAP-TTLS, EAP-FAST, IKE, PEAP, SNMPv3, SSL/TLS (HTTPS)	
Operating conditions	0 to 70°C, 20 to 80 % RH, no condensation	
Storage conditions	-20 to 50°C, 20 to 90 % RH, no condensation	
EMI conformity	FCC Class B (USA), CE (EU), VCCI Class B (Japan)	

Wireless Network Interface Kit (IB-51) (Option)

Item		Description		
CPU		SoC 88F6180		
RAM		64 MBytes		
ROM		16 MBytes		
Wireless network interface	IEEE802.11b	Frequency	2.4GHz	
		Transmission system	DS-SS	
		Transmission speed	1 / 2 / 5.5 / 11 (Mbps)	
		Channel	1-11ch	
	IEEE802.11g	Frequency	2.4GHz	
		Transmission system	OFDM	
		Transmission speed	6 / 9 / 12 / 18 / 24 / 36 / 48 / 54 (Mbps)	
		Channel	1-11ch	
	IEEE802.11n	Frequency	2.4GHz	
		Transmission system	OFDM	
		Transmission speed	Max 300Mbps	
		Channel	1-11ch	
	Authentication method		Open System / Shard Key / WPA / WPA2	
	Encryption mode		None / WEP (64bit / 128bit) / TKIP / AES When running in IEEE 802.11n, only AES is supported.	
Antenna		Non-directional antenna × 2		
Printer interface		eKUIO (5.0V)		
Operating system		Windows XP (32bit/64bit) / Vista (32bit/64bit) / 7 (32bit/64bit) / Server 2003 (32bit/64bit) / Server 2008 (32bit/64bit) NetWare 3.x. / 4.x. / 5.x. / 6.x MacOS 9.x / Mac OS X (PowerPC: Ver 10.3.x-Ver 10.5.5 / Intel: Ver 10.4.4-Ver 10.7.x) UNIX		

Item		Description
Network protocols	IPv6	Apple Bonjour Compatible, DHCPv6, DNSv6, FTP, FTPS, HTTP, HTTPS(IPPS), ICMPv6, IKEv1, IPP, IPPS, Kerberos, LDAP, LPD, POP3, RawPort, SLP, SMTP, SNMP, SNMPv1/v2c/v3, SNTP, ThinPrint
	IPv4	Apple Bonjour Compatible, BOOTP, DHCP, DNS, FTP, FTPS, HTTP, HTTPS, ICMP, IPP, IPPS, KCP, Kerberos, LDAP, LPD, NetBIOS over TCP/IP, POP3, POP3 over SSL, RawPort, SLP, SMTP, SNMP, SNMPv1/v2c/v3, SNTP, ThinPrint, WINS
	Other	AppleTalk, IPX/SPX, LLTD, NetBEUI, NetWare (NDS/Bindery)
Security protocols		EAP-TLS, EAP-TTLS, EAP-FAST, IKE, PEAP, SNMPv3, SSL/TLS (HTTPS)
Operating conditions		0 to 60 °C, 20 to 80 % RH, no condensation
Storage conditions		-20 to 50 °C, 20 to 90 % RH, no condensation
EMI conformity		FCC Class B (USA), CE (EU), VCCI Class B (Japan)

Wireless Network Interface Kit (IB-36) (Option)

Item	Description
Installation Environment	Conforms to the machine's installation environment
Interface	Wireless Network Interface × 1 (IEEE802.11n compliant)
Power supply	From the machine

Parallel Interface Kit (IB-32B) (Option)

Item	Description
Installation Environment	Conforms to the machine's installation environment
Interface	Parallel Interface × 1 (IEEE-1284 compliant)
Power supply	From the machine

Environmental Specifications

Item	Description
Time to Sleep mode (default setting)	1 minute
Recovery time from Sleep mode	ECOSYS P3045dn: 15 seconds or less ECOSYS P3050dn: 20 seconds or less ECOSYS P3055dn: 25 seconds or less ECOSYS P3060dn: 25 seconds or less
Duplexing	Standard
Paper supply capability	100% recycled paper may be used.

 **Note** Consult your dealer or service representative for recommended paper types.

Glossary

Additional memory

An additional memory (optional) is used for increasing the memory capacity of this machine. For DIMM that can be used in this machine, contact your service technician.

AppleTalk

AppleTalk offers file sharing and printer sharing and it also enables you to utilize application software that is on another computer on the same AppleTalk network.

Auto-IP

Auto-IP is a module that enables dynamic IPv4 addresses to be assigned to a device on startup. However, DHCP requires a DHCP server. Auto-IP is a server-less method of choosing an IP address. IP addresses between 169.254.0.0 to 169.254.255.255 are reserved for Auto-IP and assigned automatically.

Bonjour

Bonjour, also known as zero-configuration networking, is a service that automatically detects computers, devices and services on an IP network. Bonjour, because an industry-standard IP protocol is used, allows devices to automatically recognize each other without an IP address being specified or DNS server being set. Bonjour also sends and receives network packets by UDP port 5353. If a firewall is enabled, the user must check that UDP port 5353 is left open so that Bonjour will run correctly. Some firewalls are set up so as to reject only certain Bonjour packets. If Bonjour does not run stably, check the firewall settings and ensure that Bonjour is registered on the exceptions list and that Bonjour packets are accepted. If you install Bonjour on Windows XP Service Pack 2 or later, the Windows firewall will be set up correctly for Bonjour.

Custom Box

The Custom Box function stores print data for each individual user on the printer and allows the user to print single or multiple copies of the stored data later using the printer's operation panel.

DDNS (Dynamic Domain Name System)

A Dynamic Domain Name System (DDNS) is a system for providing a fixed host name for IP addresses which change dynamically.

By updating the correspondence between the host name registered and the IP address as the IP address changes, it is possible to connect with the same host name even when the IP address has changed.

Default Gateway

This indicates the device, such as a computer or router, which serves as the entrance/exit (gateway) for accessing computers outside the network that you are on. When no specific gateway is designated for a destination IP address, data is sent to the host designated as the Default Gateway.

DHCP (Dynamic Host Configuration Protocol)

Dynamic Host Configuration Protocol (DHCP) that automatically resolves IP addresses, subnet masks, and gateway addresses on a TCP/IP network. DHCP minimizes the load of network management employing a large number of client computers because it relieves individual clients including printers from the IP address being assigned.

dpi (dots per inch)

A unit for resolution, representing the number of dots printed per inch (25.4 mm).

EcoPrint

This is a printing mode that reduces toner consumption. Pages printed in the EcoPrint mode are lighter than pages printed in the normal mode.

Emulation

The function to interpret and execute other printers' page description languages.

Form Feed Timeout

While data is being sent to a printer, some pauses may occur. At this time, the printer waits for the next data without making a page break. Form feed timeout is a function to wait only a preset amount of time before it executes an automatic page break. After the waiting period begins, once the designated amount of time is exceeded, the printer will automatically process the currently received data and print it out. If the machine has received no print data for the last page, the printer ends processing of that job without outputting paper.

IP Address (Internet Protocol Address)

An Internet protocol address is a unique number that represents a specific computer or related device on the network. The format of an IP address is four sets of numbers separated by dots, e.g. 192.168.110.171. Each number should be between 0 and 255.

IPP

IPP (Internet Printing Protocol) is a standard that uses TCP/IP networks such as the Internet to enable print jobs to be sent between remote computers and printers. IPP is an extension of the HTTP protocol used to view websites and enables printing to be carried out via routers on printers in remote locations. It also supports the HTTP authentication mechanisms along with SSL server and client authentication as well as encryption.

Job Box

The Job Box function stores print data on the printer and allows users to print single or multiple copies of the stored data later using the printer's operation panel.

KPDL

Kyocera's PostScript page description language compatible with Adobe PostScript Level 3.

Multi Purpose (MP) Tray

Use this tray instead of the cassettes when printing onto envelopes, Hagaki, transparencies, or labels.

NetBEUI (NetBIOS Extended User Interface)

An interface, developed by IBM in 1985, as an update from NetBIOS. It enables more advanced functions on smaller networks than other protocols such as TCP/IP, etc. It is not suitable for larger networks due to lack of routing capabilities to choose the most appropriate routes. NetBEUI has been adopted by IBM for its OS/2 and Microsoft for its Windows as a standard protocol for file sharing and printing services.

NetWare

Novell's network management software that is able to run on a variety of operating systems.

Outline font

With outline fonts, character outlines are represented with numerical expressions and fonts can be enlarged or reduced in different ways by changing the numeric values of those expressions. Printing remains clear even if you enlarge fonts, since the characters are defined with outlines represented with numerical expressions. You can specify the font size in steps of 0.25 points up to 999.75 points.

POP3 (Post Office Protocol 3)

A standard protocol to receive E-mail from the server in which the mail is stored on the Internet or an intranet.

PostScript

A page description language developed by Adobe Systems. It enables flexible font functions and highly-functional graphics, allowing higher quality printing. The first version called Level 1 was launched in 1985, followed by Level 2 that enabled color

printing and two-byte languages (e.g. Japanese) in 1990. In 1996, Level 3 was released as an update for the Internet access and PDF format as well as gradual improvements in implementation technologies.

PPM (Prints Per Minute)

This indicates the number of A4 size printouts made in one minute.

Printer driver

The software to enable you to print data created on any application software. The printer driver for the machine is contained in the *Product Library* disk enclosed in the package. Install the printer driver on the computer connected to the machine.

RA (Stateless)

The IPv6 router communicates (transmits) information such as the global address prefix using ICMPv6. This information is the Router Advertisement (RA). ICMPv6 stands for Internet Control Message Protocol, and is an IPv6 standard defined in the RFC 2463 "Internet Control Message Protocol (ICMPv6) for the Internet Protocol Version 6 (IPv6) Specification".

SD/SDHC Memory Card

An SD Memory Card is a removable storage media. It is nonvolatile semiconductor memory where the data remains even when the power supply is cut. The maximum memory capacity is 2 GB.

SDHC memory cards are a higher specification of SD memory cards. These memory cards have bigger capacities than SD memory cards and have a guaranteed minimum transfer speed.

As the file system was changed to FAT32, up to a maximum of 32 GB is supported.

Sleep mode

This mode is provided to save power. It is activated when the machine is not used for a preset period of time. In this mode, power is reduced to the minimum. The default setting can be changed.

SMTP (Simple Mail Transfer Protocol)

A protocol for E-mail transmission over the Internet or an intranet. It is used for transferring mail between mail servers as well as for sending mail from clients to their servers.

SSD (Solid State Drive)

An SSD is a media for data storage using flash memory.

Whereas HDD generally use magnetic discs as the storage media, SDD are a storage media which use semiconductors.

Compared with HDD, on which a head reads from the magnetic disk, the merits of SSD are that they can read data at higher speeds, they are resistant to vibrations, and they do not require motors, which mean that they consume less electricity and there is no drive noise.

Status page

This lists machine conditions, such as the machine's memory, the total number of prints and paper source settings. You can print the status page from the operation panel.

Subnet Mask

The subnet mask is a way of augmenting the network address section of an IP address. A subnet mask represents all network address sections as 1 and all host address sections as 0. The number of bits in the prefix indicates the length of the network address. The term "prefix" refers to something added to the beginning and, in this context, indicates the first section of the IP address. When an IP address is written, the length of the network address can be indicated by the prefix length after a forward slash (/). For example, "24" in the address "133.210.2.0/24". In this way, "133.210.2.0/24" denotes the IP address "133.210.2.0" with a 24-bit prefix (network section). This new network address section (originally part of the host address) made possible by the subnet mask is referred to as the subnet address. When you enter the subnet mask, be sure to set the DHCP setting to Off.

TCP/IP (Transmission Control Protocol/Internet Protocol)

TCP/IP is a suite of protocols designed to define the way computers and other devices communicate with each other over a network.

TCP/IP (IPv6)

TCP/IP (IPv6) is based on the current Internet protocol, TCP/IP (IPv4). IPv6 is the next-generation Internet protocol and expands the available address space, which resolves the problem of the lack of addresses under IPv4, while also introducing other improvements such as additional security functionality and the capacity to prioritize data transmission.

USB (Universal Serial Bus)

An interface standard for low to middle speed serial interfaces. This printer supports Hi-Speed USB. The maximum transfer rate is 480 Mbps and the maximum cable length is 5 meters (16 feet).

WPS (Wi-Fi Protected Setup)

WPS is a network security standard created by Wi-Fi Alliance, to make it easy to connect with the wireless devices and set up the Wi-Fi Protected Access. The WPS-supported services can connect to the wireless access points by pushing a button or entering passphrases.

Index

A

Administrator	4-136
Alternative Emulation	4-49
Anti-theft Lock Slot	1-4
Appendix	A-1
AppleTalk	Glossary-1
Auto Cassette Change	4-45
Auto-IP	Glossary-1

B

Bonjour	Glossary-1
Bulk Paper Feeder	A-10
Bulk paper feeder	
clearing paper jams	8-25
Buzzer	4-98

C

Canceling a Printing Job	3-2, 4-4
Card Authentication Kit	A-10
Cassette (1 to 5) Settings	
Cassettes	4-32
Paper weight	4-39
Cassette 1	1-2
Character Entry Method	A-2
Cleaning	
Printer	7-9
Clearing paper jams	
bulk paper feeder	8-25
Duplex unit	8-21
Inside the printer	8-22
MP tray	8-20
Paper cassette	8-20
Paper feeder	8-20
Rear unit	8-24
Code Set	4-52
Colored Paper	A-19
Command Center RX	2-28
Copies	4-55
Counter	4-29
CR Action	4-58
Custom Box	5-3
Printer driver	5-30
Custom Paper Size	
Duplex printing	4-41
Paper size	4-35
Paper weight	4-40

D

Data Security	4-126
Security password	4-127
SSD initialization	4-127
Data Security Kit	A-10
Date Setting	4-95
DDNS	Glossary-1

Developer Unit	1-3
DHCP	Glossary-1
Display Backlight	4-103
Display Brightness	4-102
Display Status/Log	4-117
Document Box	5-2
Document Box Default Screen	4-94
Duplex Front Cover	1-3
Duplex Printing	4-46
Binding modes	4-47
Permitted with custom paper	4-41
Duplex Unit	
Clearing paper jams	8-21

E

EcoPrint	4-53
Emulation	4-48
Error report	4-49
Energy Star Program	xii
Error Handling	4-103
Duplex paper error	4-103
InsertMismatch	4-104
MP tray empty	4-104
Paper mismatch	4-104
Error Messages	8-6
Expansion Memory Module	
Option	A-5

F

Faceup Output Tray	A-9
Font	4-50
Front Cover	1-3
Fuser Cover	1-4

I

ID Card Setting	4-138
Indicator	
Attention	1-5, 4-3
Data	1-5, 4-3
Ready	1-5, 4-3
Inside the Printer	
Clearing paper jams	8-22
Installing Software	2-17
Installing the Printer Driver	
Macintosh	2-21
Windows	2-17
Interface Cover	1-4

J

Job Account Setting	4-140
Job Box	5-21
Settings	5-28
Job Log History	4-16
Auto sending	4-16

Destination	4-18
Personal information	4-20
Send history	4-17
Subject	4-19
Job Name	4-59
Job Retention	5-21
Printer driver	5-30
Private print	5-25
Proof-and-Hold	5-22
Quick copy	5-22
Stored job	5-25

K

Key	
[Back] key	1-5, 4-4
[Cancel] key	1-5, 4-4
[Clear] key	1-5, 4-5
[Document Box] key	1-5, 4-5
[Left Select] key	1-5, 4-6
[Logout] key	1-5, 4-4
[Menu] key	1-5, 4-4
[OK] key	1-5, 4-5
[Right Select] key	1-5, 4-6
Arrow keys	1-5, 4-5
Numeric keys	1-5, 4-5
KIR	4-53

L

Labels	A-17
Language	4-93
Left Cover	1-2
Limited Use of This Product	-xiii

M

Machine Parts	1-1
Maintenance	4-150, 7-1
Quiet mode	4-150
Restart	4-151
Memory	
Checking expansion memory	A-6
Expansion memory	A-6
Message Display	1-5, 4-2
Language	4-93
Online help messages	8-19
Status information	4-2
Mode Selection Menu	4-9
Moving Printer	7-11
MP (Multi-Purpose) Tray	1-2
Clearing paper jams	8-20
Loading paper	2-42
Media type	4-31
Paper feed source	4-44
Paper size	4-30
MP Tray Priority	4-45

N

NetBEUI	Glossary-2
Network	
Auto-IP	4-72

Default Gateway	4-73
DHCP	4-71
DHCPv6	4-77
IP address	4-72
IPv4 Setting	4-71
IPv6 Setting	4-74
LAN Interface	4-77
Primary Network	4-80
RA(Stateless)	4-76
Restart Network	4-70, 4-81
Subnet Mask	4-73
TCP/IP	4-71
TCP/IP Settings	4-70
TCP/IP(IPv6)	4-74
Wi-Fi Settings	4-63
Wired Network Settings	4-70
Network Interface Connector	1-4
Network Interface Kit	A-7
Network Settings	2-2, 4-60
Bonjour	4-78
Enhanced WSD(SSL)	4-78
EnhancedWSD	4-78
FTP (Server)	4-78
Host Name	4-61
HTTP	4-78
HTTPS	4-78
IPP	4-78
IPP Over SSL	4-78
IPSec	4-78
LDAP	4-78
LPD	4-78
NetBEUI	4-78
POP3	4-78
RAW Port	4-78
SMTP	4-78
SNMP	4-78
SNMPv3	4-78
ThinPrint	4-78
Wi-Fi Direct settings	4-61
WSD-PRINT	4-78

O

Online Help Messages	
For clearing paper jams	8-19
Operation Panel	1-2, 1-5
Option	
Card authentication kit	A-5
Expansion memory module	A-5
Faceup output tray	A-5
Network interface kit	A-5
Paper feeder	A-5
Parallel interface kit	A-5
SD card	A-5, A-7
SSD	A-5
USB flash memory	A-5
Wireless network interface kit	A-5
Option Interface Slot	1-4
Optional Functions	4-154
Optional Network Settings	4-82
AppleTalk	4-90
Basic settings	4-89
IPSec	4-91
LAN interface	4-77, 4-91

MAC address filtering	4-91
Network	4-90
TCP/IP settings	4-69, 4-89
Wireless network	4-83
Orientation	4-57
Other Paper Size	4-34

P

Page Setting	4-55
Paper	
Colored paper	A-19
Envelopes	A-18
Guideline	A-13
Labels	A-17
Loading envelopes	2-44
Loading paper into the cassette	2-38
Loading paper into the MP tray	2-42
Media Type	4-37, 4-38
Media type	4-31, 4-39
Minimum and maximum paper sizes	A-12
Other paper properties	A-15
Paper availability	A-11
Paper Setup Msg	4-43
Paper sizes	4-30, 4-32, 4-34, A-13
Paper thickness	4-39
Postcards	A-18
Preprinted paper	A-19
Recycled paper	A-19
Resets customized settings	4-42
Special paper	A-16
Thick paper	A-19
Transparency	A-16
Paper Cassette	
Clearing paper jams	8-20
Loading paper	2-38
Non-standard paper size	4-34
Paper feed source	4-44
Paper size	4-33
Paper Type	4-37
Paper type	4-33
Standard paper size	4-32
Paper Feed Mode	4-46
Paper Feeder	A-7
Clearing paper jams	8-20
Loading paper	2-38
Paper feed source	4-44
Paper size	4-32, 4-33, 4-34
Paper Type	4-37
Paper type	4-33
Paper Jams	8-18
Locations	8-18
Message	8-18
Paper Output	4-47
Paper Size Dial	4-33
Paper Stopper	1-2, 2-45
Parallel Interface Kit	A-8
PIN Login	4-134
Postcards	A-18
Power Cord Connector	1-4
Power Cord Connector Cover	1-4
Power Switch	1-2
Preprinted Paper	A-19

Print Density	4-54
Print Quality	4-53
Print Resolution	4-54
Printer Driver	2-17
Macintosh	2-21
Windows	2-17
Printer Driver Help	3-7
Printing from Applications	3-2
Prolonged Non-Use	7-11

Q

Quiet Mode	4-150
------------------	-------

R

RAM Disk	4-100
Rear Cover	1-4
Rear Unit	
Clearing paper jams	8-24
Recycled Paper	A-19
Reduced Print	4-55
Report Print	4-10

S

SD Card	Glossary-3
Format	4-102
Security	4-121
I/F block	4-123
Network	4-122
Security Precautions when Using Wireless LAN	-xii
Service Setting	4-152
Solving Malfunctions	8-2
Specifications	A-21
SSD	A-7, Glossary-3
Format	4-101
Status Menu	6-1
Job log	6-4
Job status	6-3
Network	6-5
Option network	6-8
USB keyboard	6-5
Wi-Fi	6-6
Wi-Fi Direct	6-6
Status Page	4-12

T

Thick Paper	A-19
ThinPrint Option	A-10
TIFF/JPEG Size	4-58
Timer Setting	4-105
Auto error clear	4-115
Auto panel reset	4-107
Error clear timer	4-116
Form feed timeout	4-116
Panel reset timer	4-107
Ping Timeout	4-116
Power off rule	4-110
Power off timer	4-111
Sleep level	4-108

Sleep timer	4-110
Timer settings	
WeeklyTimer Set	4-112
Toner Alert Level	4-119
Toner Container	1-3
Toner Container Replacement	7-2
Toner Kits	7-2
Top Cover	1-3
Top Tray	1-2
Transparency	A-16
Troubleshooting	8-1, 8-2

U

Uninstalling Software	2-21
USB Interface	1-4
USB Keyboard	A-10
USB KeyboardType	4-118
USB Memory	A-8
Print	4-21
Remove	4-28
USB Memory Slot	1-2
USB Port	1-4
User Login Setting	4-129
User Name	4-59

W

Waste Toner Box	1-2
Replacing	7-7
WeeklyTimer Set	
Retry Settings	4-114
Weekly Timer	4-112
Wide A4	4-58
Wi-Fi Direct	
ConnectionStatus	6-7
Detail Info	6-7
PushButton Setup	6-7
Wi-Fi Direct Set	
Auto Disconnect	4-62
Device Name	4-62
Disconnect Timer	4-63
IP address	4-62
Wi-Fi Direct	4-61
Wi-Fi Settings	
Setup	4-64
Wi-Fi	4-63
Wireless Connection	-xii
Wireless Network Interface Kit	A-7, A-8

X

XPS Fit to Page	4-58
-----------------	------

Z

??????	
??????	4-112
??????	
Ping	4-80
????????	4-120

**QUALITY
CERTIFICATE**

This machine has passed
all quality controls and
final inspection

KYOCERA Document Solutions America, Inc.**Headquarters**

225 Sand Road,
Fairfield, New Jersey 07004-0008, USA
Phone: +1-973-808-8444
Fax: +1-973-882-6000

Latin America

8240 NW 52nd Terrace Dawson Building, Suite 100
Miami, Florida 33166, USA
Phone: +1-305-421-6640
Fax: +1-305-421-6666

KYOCERA Document Solutions Canada, Ltd.

6120 Kestrel Rd., Mississauga, ON L5T 1S8,
Canada
Phone: +1-905-670-4425
Fax: +1-905-670-8116

KYOCERA Document Solutions**Mexico, S.A. de C.V.**

Calle Arquimedes No. 130, 4 Piso, Colonia Polanco
Chapultepec, Delegacion Miguel Hidalgo,
Distrito Federal, C.P. 11560, México
Phone: +52-555-383-2741
Fax: +52-555-383-7804

KYOCERA Document Solutions Brazil, Ltda.

Alameda África, 545, Pólo Empresarial Consbrás,
Tamboré, Santana de Parnaíba, State of São Paulo, CEP
06543-306, Brazil
Phone: +55-11-2424-5353
Fax: +55-11-2424-5304

KYOCERA Document Solutions Chile SpA

Jose Ananias 505, Macul. Santiago, Chile
Phone: +562-2350-7000
Fax: +562-2350-7150

KYOCERA Document Solutions**Australia Pty. Ltd.**

Level 3, 6-10 Talavera Road North Ryde N.S.W, 2113,
Australia
Phone: +61-2-9888-9999
Fax: +61-2-9888-9588

KYOCERA Document Solutions**New Zealand Ltd.**

Ground Floor, 19 Byron Avenue, Takapuna, Auckland,
New Zealand
Phone: +64-9-415-4517
Fax: +64-9-415-4597

KYOCERA Document Solutions Asia Limited

Unit 3 & 5, 16/F., Mita Centre, 552-566, Castle Peak Road
Tsuen Wan, New Territories, Hong Kong
Phone: +852-2496-5678
Fax: +852-2610-2063

KYOCERA Document Solutions**(China) Corporation**

8F, No. 288 Nanjing Road West, Huangpu District,
Shanghai, 200003, China
Phone: +86-21-5301-1777
Fax: +86-21-5302-8300

KYOCERA Document Solutions**(Thailand) Corp., Ltd.**

335 Ratchadapisek Road, Wongsawang, Bangsue,
Bangkok 10800,
Thailand
Phone: +66-2-586-0333
Fax: +66-2-586-0278

KYOCERA Document Solutions**Singapore Pte. Ltd.**

12 Tai Seng Street #04-01A,
Luxasia Building, Singapore 534118
Phone: +65-6741-8733
Fax: +65-6748-3788

KYOCERA Document Solutions**Hong Kong Limited**

Unit 1,2,4,6,8 & 10, 16/F., Mita Centre, 552-566, Castle
Peak Road Tsuen Wan, New Territories, Hong Kong
Phone: +852-3582-4000
Fax: +852-3185-1399

KYOCERA Document Solutions**Taiwan Corporation**

6F., No.37, Sec. 3, Minquan E. Rd.,
Zhongshan Dist., Taipei 104, Taiwan R.O.C.
Phone: +886-2-2507-6709
Fax: +886-2-2507-8432

KYOCERA Document Solutions Korea Co., Ltd.

#3F Daewoo Foundation Bldg 18, Toegye-ro, Jung-gu,
Seoul, Korea
Phone: +822-6933-4050
Fax: +822-747-0084

KYOCERA Document Solutions**India Private Limited**

Second Floor, Centrum Plaza, Golf Course Road,
Sector-53, Gurgaon, Haryana 122002, India
Phone: +91-0124-4671000
Fax: +91-0124-4671001

KYOCERA Document Solutions Europe B.V.

Bloemlaan 4, 2132 NP Hoofddorp,
The Netherlands
Phone: +31-20-654-0000
Fax: +31-20-653-1256

KYOCERA Document Solutions Nederland B.V.

Beechavenue 25, 1119 RA Schiphol-Rijk,
The Netherlands
Phone: +31-20-5877200
Fax: +31-20-5877260

KYOCERA Document Solutions (U.K.) Limited

Eldon Court, 75-77 London Road,
Reading, Berkshire RG1 5BS,
United Kingdom
Phone: +44-118-931-1500
Fax: +44-118-931-1108

KYOCERA Document Solutions Italia S.p.A.

Via Monfalcone 15, 20132, Milano, Italy,
Phone: +39-02-921791
Fax: +39-02-92179-600

KYOCERA Document Solutions Belgium N.V.

Sint-Martinusweg 199-201 1930 Zaventem,
Belgium
Phone: +32-2-7209270
Fax: +32-2-7208748

KYOCERA Document Solutions France S.A.S.

Espace Technologique de St Aubin
Route de l'Orme 91195 Gif-sur-Yvette CEDEX,
France
Phone: +33-1-69852600
Fax: +33-1-69853409

KYOCERA Document Solutions Espana, S.A.

Edificio Kyocera, Avda. de Manacor No.2,
28290 Las Matas (Madrid), Spain
Phone: +34-91-6318392
Fax: +34-91-6318219

KYOCERA Document Solutions Finland Oy

Atomitie 5C, 00370 Helsinki,
Finland
Phone: +358-9-47805200
Fax: +358-9-47805390

KYOCERA Document Solutions**Europe B.V., Amsterdam (NL) Zürich Branch**

Hohlstrasse 614, 8048 Zürich,
Switzerland
Phone: +41-44-9084949
Fax: +41-44-9084950

KYOCERA Bilgitas Document Solutions**Turkey A.S.**

Gülbahar Mahallesi Otello Kamil Sk. No:6 Mecidiyeköy
34394 Şişli İstanbul, Turkey
Phone: +90-212-356-7000
Fax: +90-212-356-6725

KYOCERA Document Solutions**Deutschland GmbH**

Otto-Hahn-Strasse 12, 40670 Meerbusch,
Germany
Phone: +49-2159-9180
Fax: +49-2159-918100

KYOCERA Document Solutions Austria GmbH

Altmannsdorferstraße 91, Stiege 1, 2. OG, Top 1, 1120,
Wien, Austria
Phone: +43-1-863380
Fax: +43-1-86338-400

KYOCERA Document Solutions Nordic AB

Esbogatan 16B 164 75 Kista, Sweden
Phone: +46-8-546-550-00
Fax: +46-8-546-550-10

KYOCERA Document Solutions Norge Nuf

Olaf Helsetsv. 6, 0619 Oslo, Norway
Phone: +47-22-62-73-00
Fax: +47-22-62-72-00

KYOCERA Document Solutions Danmark A/S

Ejby Industrivej 60, DK-2600 Glostrup,
Denmark
Phone: +45-70223880
Fax: +45-45765850

KYOCERA Document Solutions Portugal Lda.

Rua do Centro Cultural, 41 (Alvalade) 1700-106 Lisboa,
Portugal
Phone: +351-21-843-6780
Fax: +351-21-849-3312

KYOCERA Document Solutions**South Africa (Pty) Ltd.**

KYOCERA House, Hertford Office Park,
90 Bekker Road (Cnr. Allandale), Midrand, South Africa
Phone: +27-11-540-2600
Fax: +27-11-466-3050

KYOCERA Document Solutions Russia LLC.

Building 2, 51/4, Schepkina St., 129110, Moscow,
Russia
Phone: +7(495)741-0004
Fax: +7(495)741-0018

KYOCERA Document Solutions Middle East

Dubai Internet City, Bldg. 17,
Office 157 P.O. Box 500817, Dubai,
United Arab Emirates
Phone: +971-04-433-0412

KYOCERA Document Solutions Inc.

2-28, 1-chome, Tamatsukuri, Chuo-ku
Osaka 540-8585, Japan
Phone: +81-6-6764-3555
<http://www.kyoceradocumentsolutions.com>

